

75 cents

*hr*<sub>vr</sub>

focus  
on  
communications  
technology . . .

# ham radio

magazine

JANUARY 1970



## RF POWER TRANSISTORS

*in amateur  
transmitters*

### *this month*

- high-frequency mosfet converter 28
- antenna couplers 32
- speech processor 38
- 432 MHz transverter 48

**ALABAMA**  
BIRMINGHAM  
Ack Radio Supply Co.  
**ALASKA**  
ANCHORAGE  
Yukon Radio Supply  
**CALIFORNIA**  
ANAHEIM  
Henry Radio Co., Inc.

**GEORGIA**  
ATLANTA  
Ack Radio Supply Co.  
ATLANTA  
Specialty Distributing Co., Inc.

**HAWAII**  
HONOLULU  
Honolulu Electronics

**ILLINOIS**  
CHICAGO  
Newark Electronics Corp.  
PEORIA  
Klaus Radio & Electric Co.

**INDIANA**  
INDIANAPOLIS  
Graham Electronics Supply, Inc.  
SOUTH BEND  
Radio Distributing Co.

**IOWA**  
COUNCIL BLUFFS  
World Radio Laboratories

**LOUISIANA**  
NEW ORLEANS  
Sterling Electronics

**NEW HAMPSHIRE**  
CONCORD  
Evans Radio, Inc.  
**NEW JERSEY**  
SPRINGFIELD  
Federated Purchaser, Inc.

**NEW YORK**  
AMSTERDAM  
Adirondack Radio Supply, Inc.  
FARMINGDALE  
Harrison Radio Corp.  
ITHACA

Stellar Industries,  
Division of Stellar, Inc.

**JAMAICA**

Harrison Radio Corp.

**NEW YORK**

Harrison Radio Corp.

**NEW YORK**

Harvey Radio Co., Inc.

**NORTH CAROLINA**

ASHEVILLE

Freck Radio & Supply Co., Inc.

WINSTON-SALEM  
Electronic Wholesalers, Inc.

**OHIO**

CLEVELAND

Pioneer Standard Electronics, Inc.

COLUMBUS

Universal Service

DAYTON

Srepco Electronics

TOLEDO

Selectronic Supplies, Inc.

**OREGON**

PORTLAND

Portland Radio Supply Co.

**PENNSYLVANIA**

JENKINTOWN

"Ham" Burger

PHILADELPHIA

Radio Electric Service Co.

PITTSBURGH

Cameradio Co.

**SOUTH DAKOTA**

WATERTOWN

Burghardt Radio Supply

**TENNESSEE**

NASHVILLE

Electra Distributing Co.

**TEXAS**

ABILENE

Howard Radio

CORPUS CHRISTI

Douglas Electronics

DALLAS

Electronic Center, Inc.

EL PASO

McNicol, Inc.

HOUSTON

Madison Electronics Supply

**WASHINGTON**

SPOKANE

HCJ Electronics

TACOMA

C & G Electronic Co.

**WISCONSIN**

MILWAUKEE

Amateur Electronic Supply

**BURLINGAME**

Ham Radio Outlet

**FRESNO**

Dymond Electronics

LOS ANGELES

Henry Radio Co., Inc.

**RIVERSIDE**

Mission Ham Radio Supply

**SAN DIEGO**

Western Radio & TV Supply Co.

**SAN JOSE**

Quement Electronics

**COLORADO**

DENVER

Burstein-Applebee Co. of Colorado

**CONNECTICUT**

HARTFORD

Corky's Division, Hatry of Hartford, Inc.

**DISTRICT OF COLUMBIA**

WASHINGTON

Electronic Wholesalers, Inc.

**FLORIDA**

CORAL GABLES

International Electronic Systems, Inc.

**MIAMI**

Amateur Radio Center, Inc.

**PENSACOLA**

Grice Electronics, Inc.

**TAMPA**

Kinkade Radio Supply, Inc.

**MARYLAND**

WHEATON

Uncle George's Radio Ham Shack,  
Division of Electronic Dist., Inc.

**MASSACHUSETTS**

BOSTON

DeMambo Radio Supply Co., Inc.

READING

Graham Radio, Inc.

**MICHIGAN**

ANN ARBOR

Purchase Radio Supply

**DETROIT**

Radio Supply & Engineering Co., Inc.

**MUSKEGON**

Electronics Distributors, Inc.

**MINNESOTA**

MINNEAPOLIS

Electronic Center, Inc.

**MISSOURI**

BUTLER

Henry Radio Co., Inc.

**KANSAS CITY**

Burstein-Applebee Co.

**ST. LOUIS**

Ham Radio Center

## Now a full-year warranty at your Collins distributor

Collins S-Line and KWM-2 are so reliable they're now warranted for one full year.

Collins distributors are just as reliable as the amateur equipment they handle. See the Collins S-Line and KWM-2 at one of these distributors today.



# SO YOU WANT CRYSTALS FASTER!



# 24

**HOUR DELIVERY ON  
ALL ORDERS OF TEN  
CRYSTALS OR LESS**

**...well it will take someone  
with manufacturing  
"know how" to do it**

But of more importance the crystal must be manufactured to Strict Specifications, have good activity and operate "on frequency" in the circuit for which it was ordered.

**SENTRY** can manufacture crystals for all two-way radio equipment: Commercial, Amateur, Aircraft, Military and Citizen Band. You need only to specify the model of set and channel frequency.

You don't believe it, when we say - "Buy the Best"?

You are satisfied with your present supplier?

You are satisfied with high prices?

You are satisfied with "second best"?

Until you try **SENTRY** you will never know!

Try Us! Make Us Prove It! "Buy the Best"



SEND FOR OUR CATALOG OF PRECISION  
QUARTZ CRYSTALS AND ELECTRONICS  
FOR THE COMMUNICATIONS INDUSTRY.  
**IT WILL COST YOU NOTHING!**

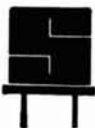

## **SENTRY MANUFACTURING COMPANY**

**Crystal Park, Chickasha, Oklahoma 73018**

**PHONE: 405-224-6780**

# HAMMARLUND

## DESK TOP LINEAR

well reared — works good up front - too!



# 2 KW

PEAK POWER INPUT

# HXL-1

*linear amplifier*

**Hammarlund tradition demands quality one notch better than the rest!**

So — you get . . .  
... rugged, widespaced, industrial type tuning capacitors made by the most famous name in capacitors — Hammarlund!  
... rigidly mounted "Hi Q," low loss tank coil for maximum power output!  
... oversize power transformer specially designed to handle "peak power" requirements!  
... no RF watt meter needed for proper tune up. RF output scale and linearity test provide all you need for tuning up your linear! Shows improper loading and overdrive!  
... Pi-network output circuit for efficient power transfer to your antenna!  
... high efficiency blower keeps final tubes cool for long operating life.

### FEATURES

- Complete 80 through 10 meter coverage!
- Compatible with HX-50A or any 70-100 watt exciter!
- "Wide-band" grounded grid input circuit!
- "Instant power" — no warm up needed!
- Built in DC operated antenna relay for chatter-free operation.
- Circuits monitored by multi purpose meter.
- Solid state, long life power supply.
- Control circuitry compatible with most excitors.



The **HAMMARLUND**  
Manufacturing Company Incorporated

A subsidiary of Electronic Assistance Corporation  
20 BRIDGE AVENUE, RED BANK, NEW JERSEY 07701

*These Facts Brought To You Straight From The Shoulder By The Hams At Hammarlund*



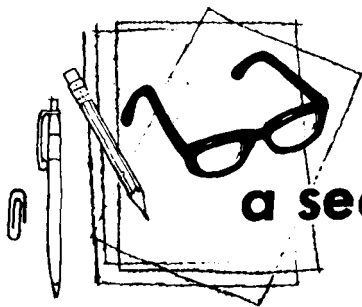

## a second look

by jim  
fisk

**Several months ago** I mentioned briefly one of the time-proven tactics for success in working DX—listen, listen, and listen some more. It's still good advice. But after you listen, then what?

With the DX-contest season approaching, I thought it would be worthwhile to pass along some words of wisdom gleaned from successful contest operators with average equipment but above-average operating knowhow. It's difficult to compete against high power and elaborate antennas, but it **can** be done. The formula is simple: sharp operating and a little luck. The idea is to refine the first so the second will be a free bonus.

Consider the inevitable pile-up of state-side stations trying to work a choice DX station. The DX station will be making contacts at a tremendous clip. Often he won't send his call for 15 or 20 minutes. To compound the problem, many U. S. hams will work him and **they** don't send his call either—takes too much time. Not only is this senseless, it's illegal for U. S. hams.

If you're with it, you'll note the DX station's frequency, move on and work others, then check his spot at frequent intervals. Sooner or later his identity will be made public. Meanwhile, the competition will have wasted precious time and contest points frantically trying to identify the mystery station.

The next step is to plan your strategy so you can leap in, latch on, and leap out. This is by no means as easy as it sounds. Here are some ideas that will help.

Note how the DX station answers calls. Perhaps he replies to stations clustered above

and below his frequency. Or maybe he works stations who transmit a few kHz higher each time. After a few contacts, a pattern will emerge. For example, how often does he answer stations on the low side of his frequency before he changes to those on the high side? By playing the law of averages, eventually you'll score.

If all seems useless despite your efforts, the wise thing to do is to move on and work other stations. Later you can return to the original pile-up, which will probably have diminished, and you can try again. Let the high-power fellows knock themselves out trying to make one difficult contact while you're busy racking up points.

### obtaining confirmations

Trying to smoke out QSL cards from foreign hams has always been a problem plaguing the DX operator. Here's an idea used by one enterprising DX enthusiast to increase QSL returns. Raised aluminum letters, such as those used for signs and house numbers, are arranged on a colored card. The card is then sprayed with a contrasting color of lacquer. Before the lacquer sets up, the card is decorated with multicolored glitter (the stuff used by stores for display ads). After the lacquer dries, the letters are flipped off. Result: a unique two-color QSL with call letters in silhouette.

Anything homemade seems to appeal to foreign amateurs. If you can boast a personalized QSL, as in this example, your returns on confirmations should increase.

**Jim Fisk, W1DTY**  
editor

# LOOK

## WHAT WE HAVE... GALAXY'S NEW FM-210



IF YOU THOUGHT YOU COULDN'T AFFORD "GALAXY" . . . LOOK AGAIN. THE FM-210 IS A TOP QUALITY AMERICAN MADE 2 METER FM TRANSCEIVER WITH A PRICE TAG THAT ALL CAN AFFORD. THIS FULLY SOLID STATE, FET FRONT END TRANSCEIVER OFFERS NO COMPROMISE PERFORMANCE FOR DIRECT OR REPEATER COMMUNICATIONS. ITS POWER INPUT IS A FULL 5 WATTS OR 10 WATTS WITH THE OPTIONAL AC-DC POWER BOOSTER. CALL, WRITE, OR COME IN. LET US SHOW YOU THE SPECS . . . YOU'LL WONDER HOW GALAXY DID IT FOR ONLY \$199.95.

POWER BOOSTER: PROVIDES HIGH POWER OPERATION FROM EITHER 12-14 VDC OR 117 VAC. MAKES AN IDEAL STATION ACCESSORY — \$49.00

■ *Henry Radio has a great antenna package program . . . big savings. Write for literature.* ■

EASY FINANCING • 10% DOWN OR TRADE-IN DOWN • NO FINANCE CHARGE IF PAID IN 90 DAYS • GOOD RECONDITIONED EQUIPMENT • Nearly all makes and models. Our reconditioned equipment carries a 15 day trial, 90 day warranty and may be traded back within 90 days for full credit toward the purchase of NEW equipment. Write for bulletin. Export inquiries invited.

TED HENRY (W6UOU)

BOB HENRY (W0ARA)

WALT HENRY (W6ZN)

# Henry Radio

11240 W. Olympic Blvd., Los Angeles, Calif. 90064 213/477-6701  
931 N. Euclid, Anaheim, Calif. 92801 714/772-9200  
Butler, Missouri 64730 816/679-3127

*"World's Largest Distributor of Amateur Radio Equipment"*

## a word from the publisher

**As we move into** volume III of *ham radio* it is a good time to stop for a minute and look back at the 22 months behind us and the future that lies ahead.

In many ways a magazine is much like a person. In its early years it is affected by the personalities and ideas of its parents. It is apt to change during this period as these parents try out new ideas in the up-bringing of their new offspring. Some work out—some don't. We can cite several of each.

As the youngster begins to move out into the world new influences begin to have their shaping effect. The subject tries to accommodate some; others seem less desirable and are avoided. You, our readers, have provided many of these influences and *ham radio* has tried to react to the many letters and suggestions which we have received. Some we have followed, while others have had to be discarded as they did not fit into the overall plans we had in mind.

One change which we're introducing this month is our new binding. This has been done mainly to overcome complaints which we have received about the magazine coming apart after going through the mail. The newer binding is a stronger one which should eliminate this problem once and for all.

None of your ideas have gone unheeded, however. We always appreciate hearing both pros and cons of *ham radio*. In fact, we must hear them if we are to do our job properly. If this magazine is not answering your needs, then it is failing in its basic mission. We don't feel this is the case, but it's up to you to let us know how we're doing.

Finally, our hero begins to move out in the world and find himself. Much of this time may be spent looking for challenges. One such opportunity recently presented itself, and *ham radio* was quick to accept. We have taken over the subscription obligations of *FM Magazine* which until recently was very capably published by Mike Van Den Branden, WA8UTB. All *FM* subscribers will receive a

like number of issues of *ham radio* for the months they had remaining of *FM*. Those who were subscribers to both magazines will receive an appropriate extension of their *ham radio* subscription.

This means a boost of several thousand subscribers for which we are justly thankful; but it also means much more. It means that we now reach more of the serious vhf fm operators than any other publication. *Ham radio* wants to treat this responsibility properly. With the help of Jay O'Brien, W6GDO, our fm editor, and Mike Van Den Branden, we will try to offer some really good fm material to keep our new readers up to date and introduce our older readers to this rapidly growing segment of our hobby. You can help also by lining up some good articles of this type for us and by letting us know what you would like us to print. Remember that *ham radio* pays on acceptance for any material we use.

Please bear with us for a month or so as we have not really had a chance yet to allow for this new responsibility. Lead times being what they are, it will be another month or so before we can line up some good articles and get them into print.

Another good opportunity presented itself a while back when we were offered the opportunity to sponsor one of those fabulous free cocktail parties at the SAROC Convention to be held in Las Vegas, February 4 through 8. Our night will be Thursday, February 5 and we hope you'll be there. Remember, this is an amateur radio show unlike any other. If you've never been to SAROC you owe it to yourself to go this year. If you've been before I know you'll be back. It's at a new hotel this year and SAROC Chairman, Len Norman, W7PBV assures us that it will be bigger and more exciting than ever before: full details are in the SAROC ad on page 78. See you in Las Vegas.

**Skip Tenney, W1NLB**  
publisher



# For The Experimenter!

## International EX Crystal & EX Kits

OSCILLATOR / RF MIXER / RF AMPLIFIER / POWER AMPLIFIER

### Type EX Crystal

Available from 3,000 KHz to 60,000 KHz. Supplied only in HC 6/U holder. Calibration is  $\pm .02\%$  when operated in International OX circuit or its equivalent. (Specify frequency)



# \$395



#### OX OSCILLATOR

Crystal controlled transistor type.

Lo Kit 3,000 to 19,999 KHz

Hi Kit 20,000 to 60,000 KHz

(Specify when ordering)

# \$295

#### MXX-1 Transistor RF Mixer

**\$3.50**

A single tuned circuit intended for signal conversion in the 3 to 170 MHz range. Harmonics of the OX oscillator are used for injection in the 60 to 170 MHz range.

Lo Kit 3 to 20 MHz

Hi Kit 20 to 170 MHz

(Specify when ordering)

#### SAX-1 Transistor RF Amplifier

**\$3.50**

A small signal amplifier to drive MXX-1 mixer. Single tuned input and link output.

Lo Kit 3 to 20 MHz

Hi Kit 20 to 170 MHz

(Specify when ordering)

#### PAX-1 Transistor RF Power Amplifier

**\$3.75**

A single tuned output amplifier designed to follow the OX oscillator. Outputs up to 200 mw can be obtained depending on the frequency and voltage. Amplifier can be amplitude modulated for low power communication. Frequency range 3,000 to 30,000 KHz.

#### BAX-1 Broadband Amplifier

**\$3.75**

General purpose unit which may be used as a tuned or untuned amplifier in RF and audio applications 20 Hz to 150 MHz. Provides 6 to 30 db gain. Ideal for SWL, Experimenter or Amateur.



MXX-1



SAX-1



PAX-1



BAX-1

Write for complete catalog.



**CRYSTAL MFG. CO., INC.**

10 NO. LEE • OKLA. CITY, OKLA. 73102



## how to use rf power transistors

A guide to  
the practical use  
of rf power transistors  
in amateur radio equipment,  
including  
circuit design,  
matching networks  
and construction

Ever since transistors were announced many years ago, hams have been interested in using them in all types of equipment. Though the advantages of transistors have made them popular for all electronic applications, transistors are especially suitable for portable equipment. Transistors, with their high efficiencies, small size, low heat dissipation, low voltage operation and high reliability, are ideal for portable gear. Many low-power transistor transmitters have appeared in ham magazines, and every circuit of this type that has appeared has attracted considerable attention. Unfortunately though, many of the transistors used in these transmitters are really not ideal for this use, since they are switching transistors or low-power amplifiers that don't perform very well in rf power service. Higher power transmitters using rf power transistors have rarely been described, and most of the circuits that have appeared really couldn't be considered very practical for most ham use.

Old rf power transistors suffer from four major faults that have limited their usefulness: low gain, limited power output, high cost, and perhaps most discouraging, susceptibility to destruction due to mismatch or detuning. This last was especially bad in mobile applications where parking too close to a vertical pipe or having your antenna touch a tree could blow out an expensive power transistor if you happened to be transmitting at the time. Various complex schemes were developed to prevent this from happening, but most were not completely satisfactory. Fortunately, new transistors overcome most of these faults.

As you probably realize, the market for transistors in amateur equipment is miniscule compared to the market in the mobile communications equipment used in police cars, ambulances, taxicabs, and so forth, not to mention the transmitters used in aircraft and military equipment. However, the amateur benefits from the improvements that result from developing new transistors for these applications. Because these markets are large and growing, transistor manufacturers have been developing highly improved transistors for these uses.

These new power transistors have higher

Paul Franson, WA7KRE, 7430 East Minnezona Avenue, Scottsdale, Arizona 85251

gain and higher power output than earlier devices (up to 100 watts in one transistor at 175 MHz). They are also rugged and can withstand detuning and mismatching that would destroy earlier devices. Their cost is reasonable for the applications they are intended for. While prices are still high compared to vacuum tubes which can supply the same power, the advantages of transistors have made them the overwhelming choice in new applications. Very little new communications equipment for mobile use is presently being designed with vacuum tubes.

For applications that require high efficiency, small size, and high reliability transistors are used even when they are quite a bit more expensive than equivalent types. For instance, in aerospace communications, literally dozens of transistors are used in parallel in some applications to obtain very high output.

In spite of this, transistors are not replacing vacuum tubes in all applications. The amateur operator who wants to put out 2,000 watts is not likely to use transistors

except in the driver stages where the transistors can make a very compact and efficient assembly.

At the present time, low-power transistors are quite reasonable. For higher power a few devices are now becoming available

fig. 2. The geometry of a Motorola balanced-emitter (resistor stabilized) transistor, the 2N5637, which is capable of 20 watts output (minimum) at 400 MHz. The 2N5637 is composed of 220 individual small transistors connected in parallel, each emitter. This construction provides excellent safe area and resistance to damage from detuning or high vswr.

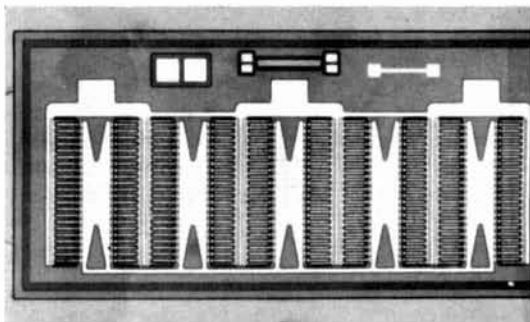
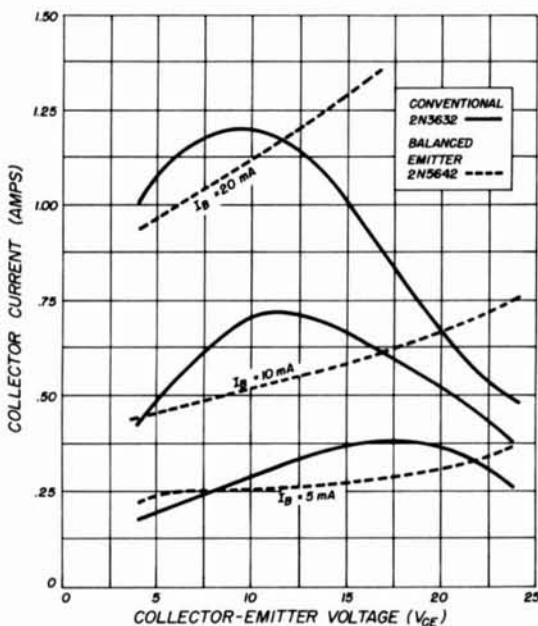

fig. 1. Comparison of collector current vs collector-emitter voltage in conventional and resistor-stabilized transistors (balanced-emitter transistors).



on the surplus market. Most of them are not modern transistors, and suffer from many of the faults that I mentioned before, particularly failure due to mismatching or detuning. Nevertheless, they are quite useful in many applications and are a very good way to get your feet wet in rf power before you take on a more expensive project.

For that matter, dedicated hams have never had any real problems in obtaining components for their projects. The serious ham who wants to build a high power transistor transmitter can likely get the transistors he needs one way or another, just as he has been able to obtain expensive varactors for microwave use. And even though the transistors are relatively expensive, they are quite reasonable when you consider their advantages; using transistors that operate directly from a car battery, for example, eliminates the need for a relatively expensive, space-consuming inverter.

The principles outlined in this article apply equally well to small transistors used in 1- and 2-watt transmitters and to the large transistors that are necessary to get 100 watts or more of rf power output. The same design principles are used in all of these applications. The numbers will change, of course, and sometimes the networks used for coupling between the transistors will also change due to the differences in impedance levels. However, if you learn how to design a low-power transmitter you can apply the same principles when higher-power transistors become available to you.

### characteristics of rf power transistors

Modern rf power transistors are made of many individual small transistors in parallel. These transistors are formed at the same time in the manufacturing process. The small transistors are then connected in parallel with aluminum metal that is deposited on the surface of the silicon chip. Each of the small transistors handles relatively little power, hence, can be rather small in size. This is an advantage in high-frequency use.

A further development of this type of construction is the balanced-emitter transistor. Here a small resistor is placed in series with

can supply an output of 20 watts at 450 MHz. This transistor consists of 220 transistors in parallel, and is stabilized by 220 small thin-film Nichrom resistors. This device, which is more complex than most ICs, is 50 by 100 mils (0.05 by 0.1 inches) in size. You'll notice that the 2N5637 is made of ten cells. Similar cells are used in other transistors: the 2N5636, which is often used as the driver for the 2N5637, consists of six cells and can provide 7.5 watts. The 2N5635 contains two cells and can put out about 2.5 watts.

The reason for this complex construction is that it improves ruggedness. If one small transistor in the large chip starts drawing more current than another one because of some small difference in its construction, the current through it would increase. Then the voltage across the small resistor would increase, increasing the emitter-base voltage. This reduces the amount of current that this individual transistor draws. In other words, it is a self-stabilizing operation. No single transistor can draw an excessive amount of current. This protects the transistor from secondary breakdown and permits it to stabilize itself in the event of severe load mismatch or circuit detuning.

Since these small emitter resistors are in

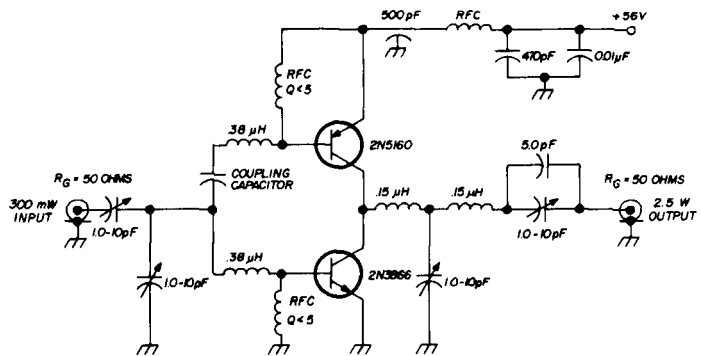

fig. 3. 300-MHz complementary rf power amplifier using npn 2N3866 and pnp 2N5160 transistors.

the emitters of the small transistors that are connected in parallel to form the whole transistor.

Fig. 2 shows a typical balanced-emitter transistor. It is the Motorola 2N5637, which

parallel, their equivalent resistance is very small and does not result in significant degeneration or loss of gain. On the other hand, if a conventional, older type of power transistor is used with emitter-resistor pro-

table 1. Typical rf power transistors

Type	Supply voltage (cw service)	Gain (min dB)	P <sub>out</sub> (min W)	@ f (MHz)	Case	Single quantity cost
2N3866	28	10	1	400	TO-39	\$ 2.25
2N3375	28	8.8	7.5	100	TO-80	10.80
2N3553	28	10	2.5	175	TO-39	4.37
2N3632	28	5.9	13.5	175	TO-80	12.75
2N4072	13.6	10	1/4	175	TO-18	2.25
2N4073	13.6	10	1/2	175	TO-5	2.70
2N4427	12	10	1	175	TO-39	2.15
2N5160*	28	8	1	400	TO-39	6.75
2N5161*	28	8.75	7.5	175	TO-60	18.75
2N5162*+	28	6	30	175	TO-60	27.00
2N5635 +	28	6.2	2.5	400	144B	7.50
2N5636 +	28	5.7	7.5	400	144B	22.80
2N5637 +	28	4.6	2	400	145A	57.50
2N5641 +	28	8.4	7	175	144B	6.40
2N5642 +	28	8.2	20	175	145A	21.30
2N5643 +	28	7.6	40	175	145A	40.40
2N5644 +	12.5	7	1	470	145A-01	11.80
2N5645 +	12.5	6	4	470	145A	15.50
2N5646 +	12.5	4.7	12	470	145A	29.20
2N5589 +	13.6	8.2	3	175	144B	6.10
2N5590 +	13.6	5.2	10	175	145A	14.40
2N5591 +	13.6	4.4	25	175	145A	25.20
MM1552 +	27	7.8	75	150	145C	67.50
MM4018*+	12.5	10	1/2	175	TO-39	2.20
MM4019*+	28	10	2.5	175	TO-39	6.50
MM4020*+	12.5	11.5	3.5	175	208-1	8.05
MM4021*+	12.5	7.0	15	175	208-1	19.50
MM4022*+	12.5	5.5	25	175	208-1	30.00
MM4023*+	12.5	5.4	40	175	208-1	49.40

\*pnp

+balanced-emitter transistor

tection, a resistor large enough to have any significant effect on the ruggedness of the transistor circuit would cause considerable loss of gain and output.

The greatest advantage of balanced-emitter transistors is their ruggedness. A balanced-emitter transistor can stand an infinite vswr for a short time in a-m service, for example. You can also tune one of these transistors without having it blow out, as often happens with older transistors.

Another result of this construction is shown in the  $I_C/V_{CE}$  curve shown in fig. 1. Here the collector currents of two transistors with similar output capability are compared. One is a balanced-emitter transistor, the 2N5642. The other is a more conventional transistor, the 2N3632. The 2N3632 contains two chips in parallel in one package, but no emitter stabilizing resistors are

included in this transistor. You'll notice that as the voltage increases in the balanced-emitter transistor, the current increases proportionately. This shows the excellent linearity which would make it ideal for amplitude modulation or linear amplification. The 2N3632 has a negative resistance region where increasing the voltage results in lower current. This negative resistance region would result in very poor upward modulation, of course, and high distortion in amplifier service.

While most silicon transistors, particularly power transistors, are npn devices, pnp rf power transistors are also made by Motorola. One, the MM4023, is a balanced-emitter transistor capable of 40 watts output at 175 MHz. The lower-power 2N5160 is a close pnp match of the popular 2N3866 and can be used in complementary service (fig. 3).

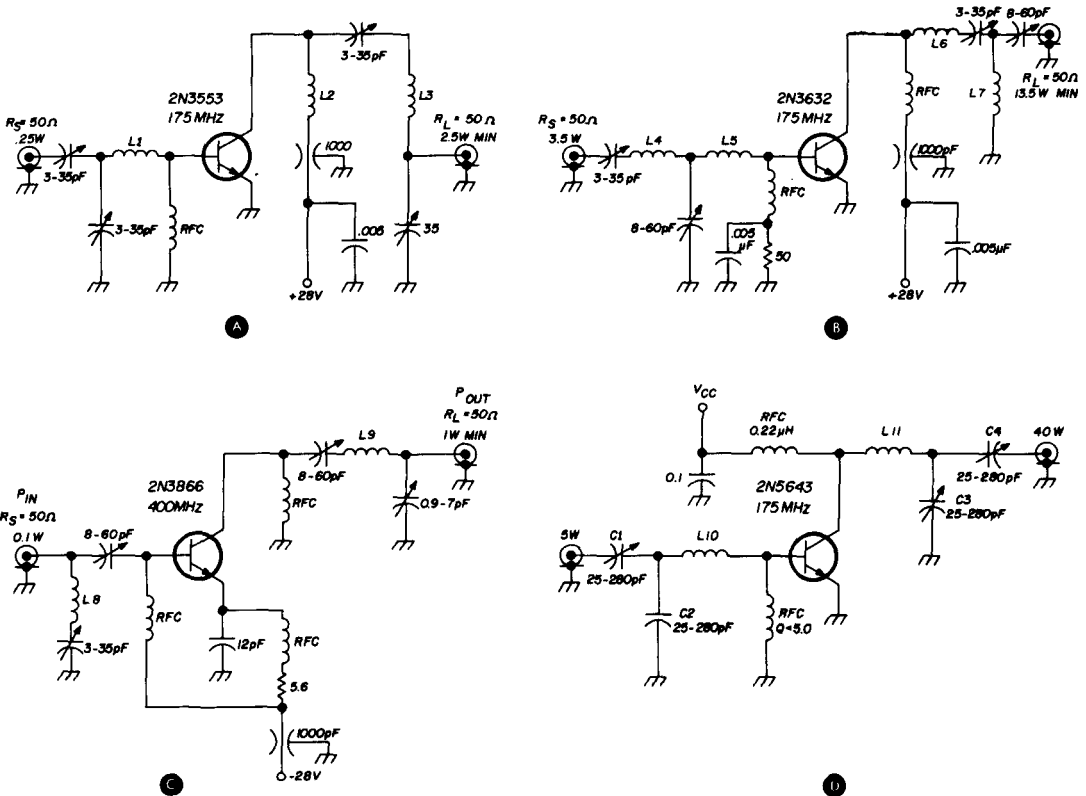

- L1, L2 2 turns no. 16 AWG, 3/16" diameter, 1/4" long
- L3 3 turns no. 16 AWG, 3/8" diameter, 3/8" long
- L4, L6 4 turns no. 18 AWG, 1/4" diameter, 3/16" long
- L5 1 turn no. 16 AWG, 1/4" diameter, 3/16" long
- L7 2 1/2 turns no. 16 AWG, 1/4" diameter, 1/4" long

- L8 1" straight no. 14 wire
- L9 1 turn no. 16, 1/4" diameter
- L10 2 turns no. 18, 1/4" diameter, 1/8" long
- L11 2-3/4 turns no. 18, 1/4" diameter, 3/16" long

fig. 4. Test circuits used for typical rf power transistors.

Table 1 summarizes a number of rf power transistors, both conventional and balanced-emitter types. The conventional ones are suitable for low power stages, for drivers, and where they will not be subjected to load mismatch or detuning. Some of these transistors are also becoming available at relatively low prices in surplus. However, only balanced-emitter transistors are recommended for use where they will be modulated, where any significant power is being handled, or for feeding an antenna. Fig. 4 gives test circuits for some of the transistors. Many of these circuits can be adapted for use in the ham bands.

## types of operation

Hams are interested in rf power transistors for four modes of operation: cw, fm, a-m and ssb. The simplest of all of these is cw operation. Keyed cw can be used in portable operation where the maximum range is desired. There's no question that this operation provides you the best range for a given power. A continuous signal can also be used for driving varactor multipliers or vacuum tubes. Fm operation is the same as cw as far as a transistor is concerned. The deviation used in any type of ham or commercial communications work is so

small that it appears as a constant signal to the transistor.

In either cw or fm operation the transistor can be operated at a supply voltage of slightly less than the collector-emitter breakdown voltage ( $BV_{CEO}$ ). For example, the 2N5641 series of transistors has a minimum  $BV_{CEO}$  of 35 volts and it is quite suitable for use at 28 volts for fm or cw operation. Likewise, transistors with an 18-volt  $BV_{CEO}$  can be used with the automobile supply, which is roughly 13.5 volts. Because you can operate relatively close to the breakdown voltage, you can get maximum power output from a transistor in cw or fm operation.

Incidentally, the collector voltage of a transistor rises to roughly twice the supply voltage during the cycle. This would seem to exceed the transistor ratings, but this is not true because the radio-frequency breakdown voltage is considerably higher than the dc voltage breakdown. It is very close to the highest maximum rating normally given on a transistor data sheet, the  $BV_{CES}$ .\* The  $BV_{CES}$  is 65 volts for the 2N5641 series.

Operation of a transistor at 28 volts requires an inverter if it is used in a car. This inverter can be relatively simple—even an autotransformer that provides voltage doubling. However, this partly negates one of the great advantages of using transistors: the fact that they can be operated directly from the 13.6 V supply voltage. These 28-V transistors are quite useful in fixed-station operation, but they are more often used in a-m service. A transistor operated at its maximum cw output, say 40 watts for the 2N5643, must be given some type of protection in case of extended detuning or mismatch. The transistor can survive a short fault but not a continuous one.

Transistors are available for operation from a car battery of 13.5 volts. They are quite similar to the higher-voltage devices but are optimized for maximum output at the lower voltage, and have lower breakdown voltages. They also have lower gain at the lower voltages. For example, the 2N5591 has an output of 25 watts at 175 MHz when oper-

\*The  $BV_{CES}$  is usually numerically about equal to the  $BV_{CBO}$ .

ated directly from a 13.5 V supply. Its power gain at this level is only 4.4 dB minimum, which is relatively low. The 2N5642, which has roughly the same output, 20 watts at 175 MHz, has a gain of 8.2 dB when it's operated at 28 V. Because of this lower gain, more stages are generally required for the same power level with low-voltage power supplies.

### amplitude modulation

Amplitude modulation with transistors is usually a rather messy proposition. Frequency modulation is much more satisfactory, and hams are using fm more and more in vhf mobile communications. However, a-m is widely used commercially in aircraft transmitters and by the military. The aircraft transmitters operate between 108 and 136 MHz, and the military use a-m between 108 and 152, and between 225 and 400 MHz. For this reason, many transistors have been developed for a-m use in these frequency ranges. The carrier output of a transistor in a-m service is very low compared to its cw output. For example, the 2N5643 can put out 40 watts on cw or fm at 175 MHz, but it's only suitable for about 15 W of a-m carrier. However, on the modulation peaks, this increases to about 60 watts PEP, of course.

In a-m operation you have to operate a transistor at less than half its collector-emitter breakdown voltage. For example, the 2N5643, which can be used at 28 V for cw operation, cannot be operated at more than about 14 V in a-m service; this is because on a-m peaks the voltage rises to twice the normal maximum, which is already twice the supply voltage. In other words, on a-m peaks a 13.5 V supply will give rf peaks that rise to 54 V. A transistor that is to be used in a-m service at 13.5 volts, then, must have a  $BV_{CES}$  greater than 54 V.

As you can see, an amplitude-modulated transistor has to be operated at about one-half its normal supply voltage, where it provides maximum gain. Its gain will be lower than that of a transistor made specifically for 13.5 V service. Amplitude modulation involves a number of compromises; it is used only because a-m equipment is already

very popular and widely used. Fm is far more satisfactory with transistors; it also provides much greater range for the same power inputs.

It might be noted, however, that large aircraft which use a-m are using transistors—single transistors such as the MM1552 which is suitable for 25 watts carrier output at 135 MHz with 100 watts peak power. The MM1552 is capable of about 75 W carrier output in cw operation. This particular transistor is used in a-m service at 13.5 V, and has a breakdown voltage of about 65 volts.

In a-m service, because the transistor is operated at relatively low carrier output, it can withstand infinite vswr and detuning for a considerable period of time if mounted on an adequate heat sink.

### ssb

Single sideband with transistors is still relatively unfamiliar to most users. Transistors have been used for single sideband for some time, particularly by the military, but not too much information is available on this type of operation. A rule of thumb is that a transistor provides fairly low distortion at a peak envelope power output roughly equal to the cw rms output. As an example, the 2N5643, which can put out 40 watts of cw, can provide 40 watts PEP of sideband with relatively low distortion.

Balanced-emitter transistors are ideal for single sideband because of their excellent linearity. At the present time an inexpensive transistor can provide about 8 to 10 watts PEP ssb, making it quite suitable for use alone or to drive an efficient transmitting tetrode tube such as the 4CX1000. This is not enough output, of course, to drive a grounded-grid tube like the popular 3-1000Z.

Table 2 summarizes the required voltage ratings of transistors used at 13.5 V and 28 V in all popular modes.

### reading data sheets

An important part of using rf power transistors is understanding their data sheets. Data sheets on any power transistor or for that matter, any semiconductor, are available from the manufacturer of the device.\* Most

of the data sheet is quite straightforward, and though different manufacturers use different formats, similar information is available from most data sheets. One of the first things that you should remember when you are looking at a data sheet is that there are different types of values given. Some are actual maximum ratings. These are the absolute limits to which a transistor should be subjected. Other values are characteristics which describe the actual performance of the transistor.

In the maximum ratings there is no problem about interpreting them; they are quite obvious. However, the characteristics can be typical values, or they can be minimum or maximum values. The manufacturer chooses the value to give him a reasonable yield of salable devices. At the same time, most of the transistors that he produces exceed the minimum ratings, sometimes by quite a bit. For this reason, typical values are often given on data sheets. These typicals include all of the curves, except one or two such as the safe operating area curve and temperature deratings.

Typical values are very useful in design; however, it's better to design with the minimum values to be on the safe side and insure that your design works properly. The data sheet clearly differentiates between typical and minimum values.

Among the curves which provide typical values are those giving impedances, where it is not practical to give a range. In this case, many transistors are measured, and an average value is put on the curves. These values can vary a bit in individual transistors, but the numbers indicated are usually quite close and satisfactory for circuit design.

One of the first ratings or characteristics that you are concerned about is the breakdown voltage of the transistor as discussed in the section on classes of operation. Many different breakdown voltages are provided on data sheets. The most significant one for rf use is the  $BV_{CES}$ . If this is not provided, the  $BV_{CBO}$  is usually numerically about the

\*Data sheets on any transistors mentioned in the text are available from Technical Information Center, Motorola Semiconductor Products Inc., Box 20924, Phoenix, Arizona 85036.



same. Half of this value gives you the maximum rating for cw or fm use; one-quarter of it for a-m use, as shown in **table 2**.

It's interesting to notice the trade-offs that accompany a higher breakdown voltage in a given family of transistors. A higher breakdown voltage indicates a lower output capacitance or  $C_{OB}$ . This, of course, can simplify design at high frequencies considerably by reducing the amount of parallel output capacitance. An unfortunate result of higher breakdown voltage is higher dc and rf saturation voltages. The reason this is important is that the actual output from a transistor is dependent on the collector voltage swing, or difference between the collector supply voltage and the saturation voltage.

**table 2. Minimum  $BV_{CEO}$  and  $BV_{CES}$  for transistors used in various modes of operation at 13.5 and 28 V. Values for a-m assume 100% modulation.**

	13.5 V Supply		28 V Supply	
	$BV_{CES}$	$BV_{CEO}$	$BV_{CES}$	$BV_{CEO}$
<b>cw</b>	<b>30</b>	<b>15</b>	<b>60</b>	<b>30</b>
<b>fm</b>	<b>30</b>	<b>15</b>	<b>60</b>	<b>30</b>
<b>a-m (transformer modulation)</b>	<b>60</b>	<b>30</b>	<b>120</b>	<b>60</b>
<b>a-m (series modulation)</b>	<b>30</b>	<b>15</b>	<b>60</b>	<b>30</b>
<b>ssb (linear amplification)</b>	<b>30</b>	<b>15</b>	<b>60</b>	<b>30</b>

For example, though dc saturation voltages are rarely given, for rf power devices they typically run around 1.5 to 2 volts for high voltage (28 V) transistors, and a little bit lower for low voltage ones. However, the rf saturation voltage is usually about 1.3 times higher and this reduces your power output. As you can see, if you operate a transistor with a high breakdown voltage at a low voltage, you reduce your voltage swing considerably because the high rf saturation voltage will remain roughly the same. Thus, a high breakdown voltage results in a lower maximum saturated power output. But as discussed before, a high breakdown voltage is a necessity for amplitude modulation, and so we have to live with the high saturation voltage that accompanies it. This is another

good reason to use fm rather than a-m.

Incidentally, at high operating voltages, gain is higher than at lower voltages, partly because the higher operating voltage reduces both output and feedback capacitance.

One parameter that is of relatively little importance is the maximum collector current ( $I_{C(max)}$ ). Though a safe operating area graph often lists the maximum permissible simultaneous voltage and current for the transistor, these values are usually dc or low-frequency ones and are not very relevant at 100 MHz or so. Transistors aren't often operated near their maximum collector currents, anyway, whether they are low-frequency or high-frequency devices.

A vital parameter in a high-power amplifier is the maximum power dissipation. The maximum power dissipation of a transistor is the difference between the input and the output:  $P_D = P_{in(rf)} + P_{in(dc)} - P_{out}$ . For example, if you have 1 watt of rf input and 10 watts of dc input (a total of 11 watts input) and five watts output, the dissipation is 11 minus five, or six watts. If you're using a relatively large transistor it may be able to handle this with very little extra heat sinking; however, it is important that sufficient heat sink be provided if necessary.

Dc current gain or  $h_{FE}$  is relatively important in many applications, but its significance in rf power transistors is probably not what you think. A high  $h_{FE}$  indicates a high  $f_T$  and hence a high power gain at frequencies below the  $f_T$ . Nevertheless high  $h_{FE}$  is not desirable in most rf power transistors: it results in lower maximum saturated power output, higher intermodulation distortion in single sideband use, greater change in dc gain with changing current and, perhaps most important, dc and low-frequency instability.

The lower dc stability means that it is relatively hard to stabilize the bias of the transistor in class B or AB operation for ssb. The ac instability can lead to low-frequency oscillation because the transistor has so much gain at these frequencies in comparison with the gain at the very high frequencies at which you want it to operate.

It follows that a high  $f_T$  is not necessarily

an advantage. The  $h_{fe}$  (small-signal ac current gain) and  $f_T$  are intimately related, since  $f_T$  is equal to  $h_{fe}$  times the frequency at which  $h_{fe}$  is measured. High  $f_T$  means higher output resistance in a transistor. Higher resistance can simplify matching requirements in some cases but the high  $f_T$  also means a lower input resistance at a given frequency and a lower maximum saturated power output. All in all,  $f_T$  is not really a very good indication of a transistor's performance in power amplifying service.

The important numbers for you to look for in an rf power transistor are its functional tests. Rf power transistors undergo tests for gain, power output, and in some cases, efficiency, at given frequencies. This is a rather time-consuming, and hence, expensive, operation for the manufacturer and one of the reasons that rf power transistors are more expensive than low frequency ones. However, it insures that the transistors are suitable for high-frequency operation.

The functional test can be given in a number of different ways; probably the most obvious one is a minimum power output for a given power input at a given frequency. A more common test furnishes the amount of input required for a given output. Power gains are usually given at the same frequency at which the power outputs are measured. Minimum and typical values are often given. The minimum is what you should design with; the typical is what you can hope for.

If you do a little bit of figuring, you will find that most power transistors have much lower gain than vacuum tubes you are familiar with. Therefore, more transistors than tubes are required to obtain a given power level in most cases. This is not necessarily true at relatively low frequencies: a power transistor can have very high gain at 50 MHz, for example, if it's designed for use at 400 MHz. Power gain increases about 6 dB per octave, and this can mean that you have much higher gain at lower frequencies.

However, it's not necessarily desirable to use a 400-MHz transistor at 50 MHz. If you have excessive gain you're likely to have instability. In general, about 15 dB is the maximum gain you should expect to get out of an rf power transistor and have it

remain stable. More than this and you're likely to be bothered by instability that could be hard to eliminate. In general, you should use rf power transistors only in the ranges that are indicated on the data sheet. For example, if output powers and impedances are given for a transistor between 100 MHz and 400 MHz, you could use it anywhere within that range and probably just a little bit above or below it. However, it would be best not to use this transistor at 30 MHz or below.

A relatively recent development in rf power transistor data sheets is the inclusion of large-signal impedances. Previous to this only small-signal impedances were given: a 20-W transistor might be characterized in a circuit in which it was actually just a low-level amplifier. However, when transistors are operated at high power levels, their characteristics are quite different from those at low power levels.

**Table 3** lists the high- and low-level impedances for the 2N3948 transistor at 300 MHz. You can see the vast differences between these values. If you use the small-signal impedances to design a transmitter, it won't work properly. Some manufacturers still do not give large-signal impedances, complicating the task of the designer considerably, because he must spend a great deal of time in empirical work. Incidentally, Motorola pioneered in providing large-signal impedances, and they are provided on almost all Motorola rf power transistor data sheets.

Three different large-signal impedances are provided: the input capacitance ( $C_{in}$ ), input resistance ( $R_{in}$ ), and output capacitance ( $C_{out}$ ). The output resistance ( $R_{out}$ ) can be figured from the supply voltage and output power of the specific circuit you are using, and that will be discussed in more detail further along. Incidentally, the output capacitance is roughly twice the low frequency  $C_{OB}$  in case this is not given.

There are two different ways that impedance data can be presented: in the parallel form, which is given on most Motorola data sheets, or in the series representation. A parallel form would be, for example, 6 ohms resistance in parallel with 30 pF capacitance.

The series form would be the familiar expression using  $j$ , such as  $25 - j8$  ohms. There are advantages to using either form; some networks are easier to design with the series representation, and some with parallel. It is relatively easy to switch from one to another. Later on in the discussion of network design I will indicate when you use the series and when you use the parallel form, and how you change from one to the other.

### packaging

The package for an rf power transistor is vitally important. For large power outputs, specialized packages that provide minimum lead inductance are required. Though the TO-39 package is widely used for low-power transistors such as the 2N3866 and the 2N3553, it is not suitable for powers over a few watts. The next step up is similar to the TO-39 except it provides solid terminals instead of wire leads and uses a stud for mounting (TO-60). Examples are the 2N3375 and 2N3632. These packages are shown in **fig. 5**.

A much-better package is the strip-line opposed-emitter case, which is used in one form or another by most manufacturers. This type of package provides an isolated stud for mounting. This stud may be mounted directly on a heat sink without insulating washers. Four ribbon leads are provided; two emitter leads, a collector lead and a base lead. The two emitter leads are between the collector and the base leads providing excellent isolation, and the fact that there are two of them makes it easy to provide a very low impedance ground. A wide ribbon is used for high power levels and a smaller one for lower power levels. The Motorola strip-line package is ceramic; some of the others are plastic. The most popular package is only 3/8 inch in diameter, yet can put out over 40 watts of power.

### circuit design

Hams are fortunate in at least one respect when it comes to rf power transistors: most amateur circuits are narrow band, unlike the wideband transmitters required in commercial and military a-m service. In broad-

band circuits, considerable gain often has to be sacrificed to obtain the wide band. However, hams can use the transistors in narrow-band service and obtain the performance specified on data sheets without any great problem.

The first problem that a transmitter designer must solve is the frequency at which he will generate his signal, and at what level any frequency multiplication, if that is needed, will be performed. General commercial practice seems to obtain a low-level signal at the output frequency, then perform all the power amplification at this frequency. There are a number of reasons for this: one is that in many commercial applications a frequency synthesizer is used, and its output can conveniently be at the output frequency. Another reason is that it is easier to design an amplifier stage than a multiplier. The information required for designing an amplifier can be obtained very readily from a data sheet, while that for designing a multiplier often must be obtained by cut and try. For this reason, it's usually best to plan on having a few milliwatts, say 20 to 100, at the output frequency and amplifying from there. All of the multiplication that's needed can then be done at a low level.

The next problem is whether to use a low-frequency crystal and multiply up, or to use a higher frequency crystal. A low-frequency crystal is usually necessary in fm applications where you need to use a relatively low frequency and multiply by a fairly high number to get enough deviation for fm. However, for a-m or cw, it's usually best to use as high a frequency as is practical. Since very little power output is needed, you can use an overtone crystal and just multiply a few times. For instance, for two-meter output a 72-MHz overtone crystal oscillator can provide a few milliwatts which then can be doubled. This is usually the simplest approach; more important, this high-frequency signal generation reduces the number of harmonics and sub-harmonics that you have to contend with. It's relatively difficult to eliminate frequencies every 8 MHz across the band, but easy to suppress ones that are 72 MHz from the desired frequency.

This discussion, of course, has been as-

New Motorola balanced-emitter transistors in a ceramic stripline package provide up to 20 watts output at 400 MHz (2N5637), 40 watts at 175 MHz with a 28-volt supply (2N5643), or 25 watts at 175 MHz with a 13.5-volt supply (2N5591). Also available are new transistors that are suitable as drivers for those devices or as lower-power amplifiers.

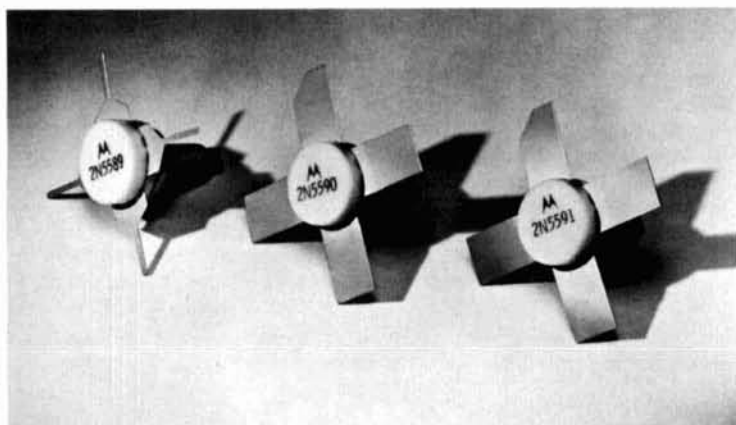

suming that you are using crystal control. If you use a variable-frequency oscillator, you'll have some other problems. Then your best bet is to use the heterodyne method so that your vfo operates at a relatively low frequency and beats against a relatively high-frequency crystal oscillator. For single sideband, of course, this is a necessity.

### transistor selection

Choosing transistors for use in a transmitter can be an interesting task. In many cases, you really have very little choice. You may have a few transistors of a given type, or you may be limited in the amount you can spend for transistors. In this case, your choice will be relatively limited. And considerably simplified, for that matter. In other

cases, you'll have to decide the power output you want, taking into account the power supply that is available, and work backwards from this. As a practical example, a simple transmitter for two meters will be developed in the rest of this article. This transmitter will also be used to explain simple network design.

Suppose we would like to obtain about 10 watts of cw or fm on two meters to drive a fixed station amplifier. A 28-volt supply will provide the highest output. A good transistor choice would be the 2N5641. It has a minimum power output of 7 watts at 175 MHz according to **table 1**. Referring to the data sheet, it can be seen that its output at 145 MHz would be much closer to 10 W. This transistor costs \$6.40 in single quantity,

fig. 5. Typical packages for rf power transistors; from left to right: TO-39, case 144B, case 145A, and case 145C. The 145C case is a 1/2" case; the others are 3/8".

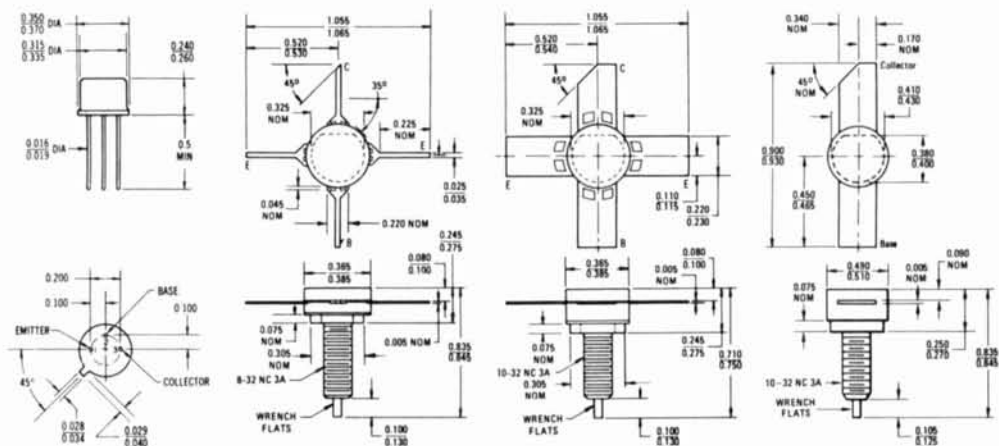

table 3. Small- and large-signal performance data for the 2N3948 at 300 MHz show the inadequacy of using small-signal characterization data for large-signal amplifier design. Resistances and reactances shown are parallel components. That is, the large-signal input impedance is 38 ohms in parallel with 21 pF, etc.

	class A Small-signal amplifier $V_{OE} = 15 \text{ Vdc}; I_c = 80 \text{ mA}$	class C Power amplifier $V_{CE} = 13.6 \text{ Vdc}; P_o = 1 \text{ W}$
Input resistance	9 ohms	38 ohms
Input capacitance or inductance	0.012 $\mu\text{F}$	21 pF
Transistor output resistance	199 ohms	92 ohms
Output capacitance	4.6 pF	5.0 pF
Power gain	12.4 dB	8.2 dB

a reasonable price for a transistor of this output. Table 4 summarizes the most important characteristics of this transistor at 145 MHz; the values were simply taken from the appropriate graphs on the data sheet.

At this frequency, the 2N5641 has an output of 9 watts for an input of 0.5 watt. To be on the safe side, we can use the 2N3866 as a driver. It has an output of 1 watt at 145 MHz with only 20 milliwatts of input, a gain of about 17 dB. This high gain is safe in this low-level stage, and should not cause any problems. A block diagram of the transmitter is shown in fig. 6.

The 20 mW of drive can be supplied by a small-signal transistor, such as a plastic-encapsulated MPS3563, an excellent transistor for this use, costing only \$0.44.

For high power levels, paralleled transistors might be needed. If this is done, some type of equalizing network must be provided to insure that both transistors receive the same drive. It's usually very difficult to use

larger or better antenna or lower loss lead-in to get this gain in transmitted output.

The transistors discussed in this article generally operate in class C. In usual transistor practice, this means they are operating without any bias except that provided by the signal, without respect to the angle of conduction. Class-C amplifiers give excellent efficiency and high power output. They are also self-protecting: if you remove the drive from a class-C amplifier, it cuts itself off and does not draw current.

Slightly more gain can be obtained from class-A, -AB or -B amplifiers, but only at the expense of higher dissipation and smaller output. These other classes of operation can provide linear operation: hence they can be used for amplifying ssb or a-m. A class-C amplifier can be used only for amplifying cw or fm.

Normally a class-C amplifier has a choke or rf coil connected directly between the base and emitter (ground), but sometimes a

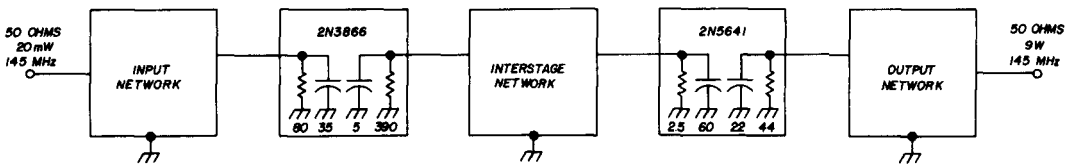

fig. 6. Block diagram of a 9-watt transmitter for two meters.

push-pull because of the problems in getting balanced drive. However, it should be remembered when considering this that only about 3 dB is gained by using another transistor in parallel. It might be easier to use a

small resistor is connected in series with the base choke. This improves efficiency slightly at the expense of gain and output. This higher efficiency is normally not required except in battery operation or where

there might be problems with heat and the higher efficiency would reduce the power dissipation.

Transistor rf power amplifiers are usually not neutralized. Neutralization of a transistor is difficult because its capacitances vary greatly with applied voltages. Almost the only type of neutralization that is used is emitter tuning. Here a small capacitor is connected from the emitter to ground and tuned for maximum output. A small choke can be placed in the emitter lead, or, at the highest frequencies the emitter lead can provide sufficient inductance by itself.

This emitter tuning can provide higher output and higher power gain, but possibly at the expense of instability. Emitter tuning is a narrow-band technique and not suitable

provide shorter ground paths than an emitter connected to the stud.

### matching networks

Matching networks are used at the input and output of a power amplifier and between transistor stages. These matching networks serve two functions: impedance transformation and frequency selection. They provide an impedance transformation between the source and input, between the output load and load, and between stages. If a transistor had exactly 50 ohm input impedance or output impedance, the network could be very simple, simply a large capacitor. However, in practice the impedances are usually quite different from 50 ohms. In high-power transistors, the input

**table 4. Characteristics of 2N3866 and 2N5641 at 145 MHz and 28 V.**

Type	Input	Output	Gain	$R_{IN}$	$C_{IN}$	$C_{out}$
2N5641	0.5 W	9 W	12.5 dB	2.5 ohms*	60 pF*	22 pF*
2N3866	20 mW	1 W	17 dB	80 ohms**	35 pF**	5 pF**

\*at 7 W output

\*\*at 1 W output

for most commercial use. Hams can use it because it is not too difficult to tune up one transistor for maximum power output. However, more conservative design does not accept emitter tuning.

Grounded-emitter operation is almost universal in rf power design. The grounded-base configuration is less stable, and adjustments for grounded-base amplifiers are more critical. If neutralization is required, it's very difficult to implement. Grounded-base amplification might be desirable in some applications, but grounded-emitter stages are usually much more satisfactory. In fact, transistors such as those in the strip-line opposed-emitter package have two emitter leads which are connected directly to ground. These transistors would not be very convenient for grounded-base operation.

In some rf power transistors, the emitter is internally grounded to the stud which helps reduce emitter inductance when the chassis is the rf ground. However, where the transistor is placed through a hole in a circuit board, the two emitter leads can

impedance is often less than 1 ohm, and the output impedance only slightly larger.

The matching network also discriminates against unwanted frequencies. A simple network usually cannot provide sufficient discrimination, and it's always desirable to use an antenna filter with any type of transmitter that you connect to an antenna.

Transformer or loop coupling is rarely used in transistor rf power amplifiers. This type of coupling is hard to adjust for maximum power output and maximum power transfer, particularly at higher frequencies. Instead, simple T networks and L networks are commonly used. Pi networks are rarely used in transistor stages because they often result in impractical component values, such as 0.5 pF capacitance or 20 nH\* inductance, whereas other networks give practical values that can be used in a transmitter.

Tuned lines and coaxial cavities provide high efficiencies and frequency discrimination, but they are very bulky at vhf and are

\*The nanohenry, abbreviated nH, is one-thousandth of a microhenry, so 20 nH = 0.020  $\mu$ H.

rarely used for this reason. In the uhf region, circuits are often built with strip-line techniques. These copper lines deposited on ceramic or high-frequency circuit board give excellent results and are used in many commercial and military applications.

## selecting Q

An important part of any rf network design is choosing the loaded Q. A loaded Q between 4 and 12 provides a good compromise between various considerations. It provides convenient values with most networks, sufficient harmonic attenuation, good efficiency and smooth tuning. The loaded Q, incidentally, is quite different from the unloaded Q of the components. The loaded Q is dependent on the reactance of the components and the output resistance of the transistor. On the other hand, the unloaded Q is determined by the Q of the coils or capacitors and is far higher.

The efficiency of a network depends on the ratio of unloaded Q to loaded Q. Low loaded Q provides easy tuning and high efficiency, but it also provides poor harmonic attenuation. Very high loaded Q's provide excellent attenuation of harmonics but result in critical tuning and high circulating currents which usually result in poor efficiency with practical coils and capacitors. Since an output filter must be considered a necessity in modern operation, the actual value of Q is not critical.

## network design

The next step is designing the required matching networks. There are a number of approaches to this problem. Perhaps the easiest is using an admittance chart but it is a little involved for this discussion. Another convenient one is the Motorola application note, "Matching Network Designs with Computer Solutions," by Frank Davis.<sup>1</sup> This application note is very easy to use; you simply figure out what kind of network you want to use, which is dependent largely on the values you have to match, and look up the proper values in a table.

I highly recommend that you get a copy of this note if you are going to be doing any transmitter designing. The note includes

tables for designing with a number of different types of networks. However, this note is not necessary for circuit design; it can be solved with simple mathematics.

The most commonly used networks are shown in **table 5** with the formulas that are used for solving them. Some of these networks are shown with solutions for a 50-ohm load or source; others are suitable for matching any impedance to any other impedance within certain limitations. Be sure to take note of these limitations: some output networks are only suitable for matching impedances below 50 ohms to 50 ohms; others can be used only for impedances above 50 ohms; still others can be used for matching a wide range of values to 50 ohms.

A point to notice is that some of these networks call for a series representation of the transistor representation. The equations used for converting from series to parallel and from parallel to series are given in **table 6**.

Often in a solution of one of these networks the component values that are obtained are not very practical. If this happens another type of network will have to be chosen. In some cases it may be necessary to use two networks in series to obtain a practical impedance transformation.

You may have noticed in **table 4** that the values of the collector resistance for the two transistors were not given. These values are best computed from the power output of the stage and the supply voltage:

$$R_L' = \frac{(V_{CC})^2}{2 P_o}$$

where  $R_L'$  is the output resistance of the transistor,  $V_{CC}$  is the supply voltage, and  $P_o$  is the power output.

This is an approximation and does not account for the rf saturation voltage, but it's accurate enough for design. With this formula it is easy to figure the output resistance of the two transistors: for the 2N3866,  $R_L' = 28^2/(2 \times 1) = 390$  ohms; for the 2N5641,  $R_L' = 28^2/(2 \times 9) = 44$  ohms.

The next step is to determine what types of network should be used to match the input to the driver transistors, the driver tran-

fig. 7. This 9-watt transmitter for 145 MHz illustrates circuit design. In practice variable capacitors would be used, of course.

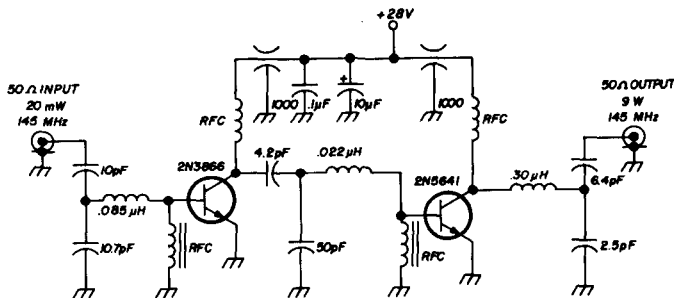

sistor to the output transistor, and the output transistor to the load.

Referring to **table 5**, it appears that the most suitable network to match the output impedance of the 2N5641 to the 50-ohm load is the one shown in **table 5A**. The same network is also useful as an input network. Note that to compute this network the transistor output impedance should be in series form rather than the parallel form given on most of the data sheets and in **table 4**. Use the equations given in **table 6B** to convert from parallel to series representation. Incidentally, the reactances here can be figured most easily from a reactance rule such as the Shure rule, or from a table.

Now let's go through the whole design procedure using the steps listed in **table 5A**:

1. Convert the parallel form to series (see **table 6B**):

$$R_s = \frac{R_p}{1 + \left(\frac{R_p}{X_p}\right)^2}$$

To use this formula we need to find  $X_p$ , the reactance of a 22 pF capacitance at 145 MHz.

$$X_p = \frac{1}{2\pi fC} = \frac{1}{2\pi (145 \times 10^6) (22 \times 10^{-12})} = 50 \text{ ohms}$$

This can also be found with a reactance slide rule or table.

Therefore,

$$R_s = \frac{44}{1 + \left(\frac{44}{50}\right)^2} = 25 \text{ ohms}$$

$$X_s = R_s \left(\frac{R_p}{X_p}\right) = 25 \frac{44}{50} = 22 \text{ ohms}$$

2. Let  $Q_L = 5$ . This will provide adequate harmonic attenuation and practical component values.

3. With  $R_o = 25$  ohms and  $X_{C_o} = 22$  ohms by step 1, calculate:

$$B = R_o (1 + Q_L^2) = 25 (1 + 5^2) = 650$$

$$A = \sqrt{\frac{B}{R_L} - 1} = \sqrt{\frac{650}{50} - 1} = 3.5$$

4. Then

$$X_L = Q_L R_o + X_C$$

and  $L = 300$  nH by a reactance chart or by  $X/2\pi f$ .

$$= AR_L = (3.5) 50 = 175 \text{ ohms}$$

and  $C_2 = 6.4$  pF (by a reactance chart or rule)

$$X_{C_1} = \frac{B}{Q_L - A} = \frac{650}{5 - 3.5} = 430 \text{ ohms}$$

and  $C_2 = 2.5$  pF.

Similar computations are performed for the input and interstage networks. A Q of 5 is also useful here. The complete circuit of the transmitter is shown in **fig. 7**.

Once you have determined the proper inductance values for the transmitter coils you must obtain the coils. For low-frequency circuits commercially available inductors can often be used. However, for most vhf use you must wind your own. Most radio handbooks give instructions for this simple operation. Use large wire sizes for lowest losses and be sure to check the inductance with a dip meter and known capacitor.

Other transmitters designed with similar networks are shown in **fig. 8** and **fig. 9**. They illustrate the capabilities of modern rf power transistors.



table 5. Matching networks.

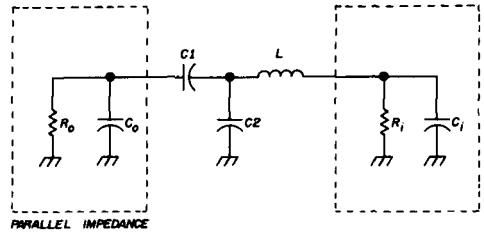
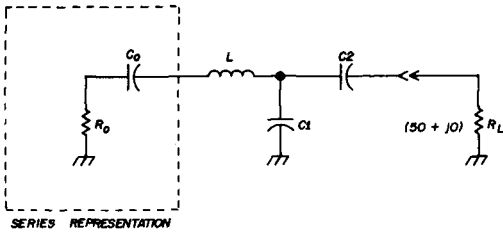

**A. Input or output matching network.**

1. Convert the parallel form of impedance to series form if needed.

2. Select a  $Q_L$  (usually 5 to 10; see text)

3. Compute:

$$B = R_0 (1 + Q_L^2)$$

$$A = \sqrt{\frac{B}{R_L} - 1}$$

4. Then

$$X_{C2} = AR_L$$

$$X_{C1} = \frac{B}{Q_L - A}$$

**B. Interstage matching network.** This network is useful when  $R_0$  is greater than  $R_i$  (which is almost always true).

1. Select a  $Q_L$

2. Compute  $A = R_i (1 + Q_L^2)$

3. Then  $X_L = Q_L R_i$

$$X_{C1} = X_{C0} \sqrt{\frac{A}{R_0} - 1}$$

$$X_{C2} = \frac{A}{Q_L - \sqrt{\frac{AR_0}{X_{C0}}}}$$

**amplitude modulation**

If you are building an a-m transmitter the modulation system is quite important. Low-level modulation is not recommended because it's inefficient. There are two major methods of high-level modulation of an a-m transmitter, transformer modulation and series modulation. Series modulation requires a supply voltage of twice the voltage required for the transmitter: an audio-frequency power transistor in series with the supply to the output stage of the transmitter operates as a variable resistance modulating the transistor output of the transmitter. This method does not use any transformers, but it requires twice the supply voltage that is needed for transformer coupling.

Transformer coupling is more conventional but it is usually difficult to find a suitable modulation transformer. Since relatively high current passes through the windings, a special transformer must be made in cases where the power levels over a watt or two.

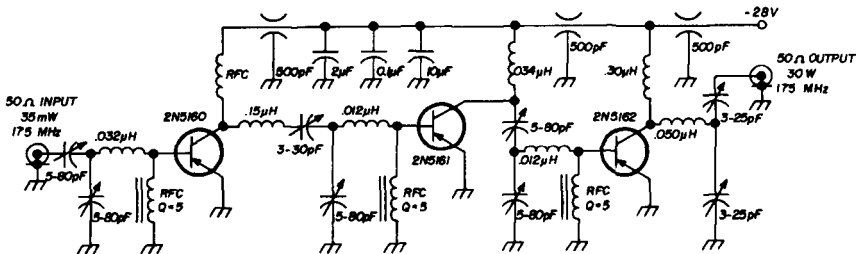
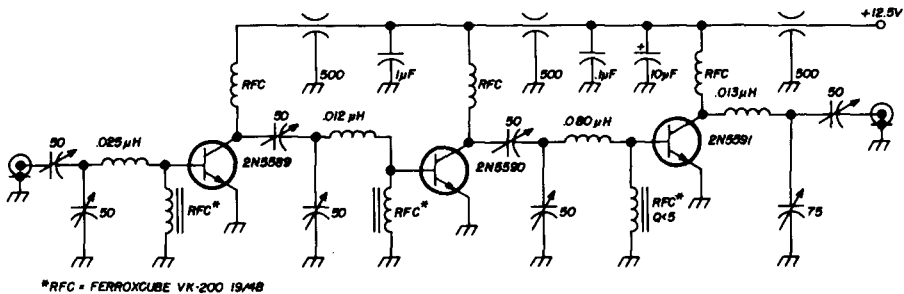

fig. 8. 30-watt 175-MHz transmitter uses pnp transistors (from Motorola Application Note AN-481).

You also have to be careful in transformer coupling so you don't apply too much supply voltage to the rf power transistor.

It is usually necessary to modulate not only the output stage in a transistor trans-

modulation to the driver, and only upward modulation to the pre-driver, as shown in **fig. 10**. The diodes limit the modulation applied to the predriver stage to upward modulation.



**fig. 9.** 25-watt, 175-MHz transmitter designed for a 12.5-volt power supply (from Motorola AN-495).

mitter but also the driver, and in some cases previous stages. This can be done by applying full modulation to the output, partial

**table 6.** Series-parallel conversion.

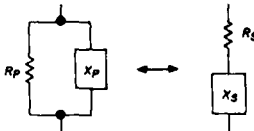

**A.** To convert a series representation of impedance to a parallel combination of resistance and reactance:

$$R_P = R_S \left[ 1 + \left( \frac{X_S}{R_S} \right)^2 \right]$$

$$X_P = \frac{R_P}{X_S/R_S}$$

**B.** To convert a parallel combination to its series equivalent:

$$R_S = \frac{R_P}{1 + \left( \frac{R_P}{X_P} \right)^2}$$

$$X_S = R_S \frac{R_P}{X_P}$$

where  $R_P$  is the parallel resistance,  $R_S$  is the series resistance,  $X_S$  is the series reactance,  $X_P$  is the parallel reactance.

$$X = 2\pi fL \text{ for inductance}$$

$$X = \frac{1}{2\pi fC} \text{ for capacitance}$$

Modulating all these stages is necessary because the gain of a power transistor is low enough that there is significant feedthrough from earlier stages. For example a transistor with 10 watts of output may have another watt contributed by the driver stage. If this stage is not modulated it will limit the maximum possible percentage of modulation.

## thermal design

An important part of the design of high-power transistor transmitters is its thermal aspects, or determining what size heat sink should be used to prevent the device from getting too hot and destroying itself. For relatively low-power transmitters this is not a great problem, and connecting the stud to a metal chassis is adequate for powers below about 15 to 20 watts. For higher powered transmitters, more attention should be paid to this topic. Thermal design at rf is similar to that at lower frequencies. However, the heat sink must also provide a good path for rf in some types of construction. Provision may also have to be made to dissipate considerable extra heat during periods of mismatch or detuning.

## practical construction

An important part of building a transistor transmitter, particularly for the vhf range, is using very short leads. The fact that wide

ribbon leads are provided for the transistors indicates the importance of this fact. The emitter leads in particular should be as short and direct as possible. An emitter resistor should not be used with balanced-emitter transistors since this is already provided internally. For some other types of transistors where insufficient protection is provided against load mismatch a small emitter resistor may be used. However, this resistor will reduce both power gain and power output.

Bypassing is critical in a high-power transistor transmitter due to the very low impedances involved. The best approach to bypassing power leads is multiple capacitors. A good technique is to use a feedthrough capacitor with other capacitors in parallel

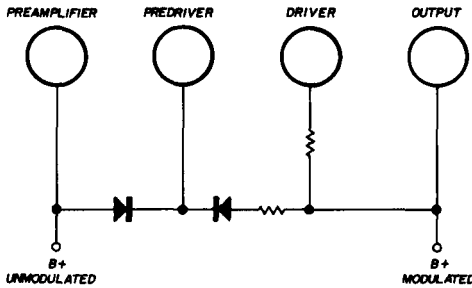

fig. 10. Modulation system providing full modulation to the output amplifier, partial modulation to the driver, only upward modulation to the predriver, and constant B+ to the preamplifier (from Motorola Application Note AN-481).

with it. For example, a 1000-pF feedthrough with a 0.1  $\mu$ F disc ceramic capacitor and a 10- $\mu$ F electrolytic capacitor in parallel helps assure good bypassing. (But don't use too much capacitance if you're applying audio for modulation.)

A good material for the chassis of a transmitter is copper or brass plate, or copper-clad printed-circuit board. If printed-circuit board is used be sure that an adequate heat sink is provided for the transistors. With these materials, components can be soldered directly to the chassis, assuring good grounds.

The input of each transistor should be

isolated from its output as much as possible; in some cases, a shield may even be necessary where high gains are used.

The chokes used in a transistor transmitter should not have high Q; low-Q chokes help avoid many problems. If a high-Q choke is used in the base lead, for example, the transistor can take off at lower frequencies. Ferrite-core chokes are excellent in many cases. Ferroxcube VK-200 chokes are often recommended. Another approach is to use a couple of ferrite beads in series with another choke or even in series with just a small resistor or a piece of wire. In most cases, some experimentation is necessary to determine the best kind of choke. It's often a good idea to put a small resistor (10 ohms or so) in parallel with the base choke.

The coils and capacitors that are used in the collector circuit should be suitable for the high circulating currents. Don't forget that in a transistor transmitter currents are often many amperes and even a very small dc resistance can cause high losses.

One other problem with any type of vhf equipment, and one that is not well recognized by many amateurs, is the fact that resistors and capacitors have different values at high frequencies than they do at the frequencies where they are measured. For example, a 100-pF silver-mica capacitor can have a much higher capacitance at 2 meters. Unfortunately, most hams do not have facilities for measuring capacitance accurately at high frequencies.

If you have access to a good vhf bridge or a slotted line you can determine the actual value of a capacitor at the frequency of interest. Lacking this you may be able to use air variables; their capacitance varies much less than silver mica and ceramic capacitors.

In most cases it's possible to avoid resistors in places in the circuit where they are subjected to rf. This can be accomplished by careful circuit design.

One other important consideration in transmitter construction is the use of a low-pass filter in the antenna lead, or even better, a bandpass filter. This is necessary in vacuum-tube transmitters to avoid interference with tv sets and other communica-

tions. It's even more important in a transistor transmitter where the circuits tend to have lower Q.

## adjustments

A few hints for testing a transistor transmitter: rule number one is not to apply any power to a stage unless it's properly loaded. This means a dummy load suitable for the power level you are using. Light bulbs are not satisfactory; a Heathkit Antenna, lossy coax cable or other good 50-ohm load is.

It's also a good idea to reduce power when you first tune up a transmitter; half voltage is enough. Adjust the tuned stages to approximate resonance if it's practical, since applying drive to a transistor without tuning its output circuit can cause problems. Probably no damage will result, though, if collector voltage is not applied to the transistor. The very low impedance of the base circuit makes it very difficult to develop enough voltage across it to blow out anything.

The usual way to tune a cw transmitter is to adjust it for maximum output with a wattmeter or dummy load and field strength meter. A better way is to look at the output on an oscilloscope. This can be done either with a direct connection to the plates of the oscilloscope, or with a mixer that will transform the high output frequency down to a frequency where your scope is usable. The mixer for this application does not need to be very complex. It's sometimes possible to use a receiver in this way if you're sure you're not overloading it.

It's a good idea to listen to the transmitter on your receiver at the output frequency. This will let you hear if any weird oscillation shows up. However, to have realistic results make sure that your receiver is not overloaded. A typical multiconversion vhf receiving system is very susceptible to overloading and all sorts of images. A simple diode detector and amplifier is probably more satisfactory for this application than your high-gain, low-noise converter.

Adjusting an amplitude-modulated transmitter is more difficult. Here you should tune for maximum upward modulation and least distortion, rather than simply maximum

power output. The two rarely correspond. Here again, looking at the signal on a scope and listening to it are imperative.

Linear amplification is the most difficult of all. Here you should tune for minimum distortion. A scope is necessary; a spectrum analyzer is very useful if you can get one. If you're not careful with a linear amplifier, particularly in single sideband service, you may end up with a very high distortion and many spurious outputs.

In adjusting a transistor transmitter it's a good idea to use a regulated power supply, at least for initial adjustments. Most transistors are very sensitive to changes in supply voltage and you will get inconsistent results if your power supply voltage varies much.

## conclusions

This article has described the present state of rf power transistors and how they can be used in ham equipment. It has not gone into great depth in any subject; however, the list of references provide more information on the design and use of rf power transistors. Although rf power transistors are still relatively expensive, they are practical and should be carefully considered for use in your transmitting equipment.

## references

1. Frank Davis, "Matching Network Designs With Computer Solutions," Motorola Application Note AN-267, Motorola Semiconductor Products, Inc., Box 20924, Phoenix, Arizona 85036.
2. Roy Hejhall, "Systemizing RF Power Amplifier Design," Motorola Application Note AN-282, Motorola Semiconductor Products Inc., Box 20924, Phoenix, Arizona 85036.
3. RCA Silicon Power Circuits Manual, Radio Corporation of America, Electronic Components and Devices, Harrison, New Jersey.
4. John G. Tatum, "Vhf/Uhf Power Transistor Amplifier Design," Application Note AN-1-1, ITT Semiconductors, 3301 Electronics Way, West Palm Beach, Florida 33407.
5. Frank Davis, "A 30-W, 175-MHz Power Amplifier Using PNP Transistors," Motorola Application Note AN-477.
6. Dick Brubaker, "A Broadband 4-Watt, Aircraft Transmitter," Motorola Application Note AN-481.
7. Roy Hejhall, "A 25-W, 175-MHz Transmitter for 12.5-Volt Operation," Motorola Application Note AN-503.
8. Dick Brubaker, "A 13-W AM Aircraft Transmitter," Motorola Application Note AN-507.

**ham radio**



# SWAN'S magnificent talking machines!

MODEL 508 VFO—SWAN 500C TRANSCEIVER—117XC POWER SUPPLY—MARK II LINEAR

For several years Swan Electronics has been specializing in value engineering of single sideband transceivers to give radio amateurs the best possible equipment at the lowest possible price. We're pleased to say that we have thousands of satisfied customers all over the world, many who have purchased their third or fourth Swan as we continue the evolutionary improvement of our product. (Trade-in value of a used Swan is well above average.) We would like to say that the station illustrated above is a typical Swan station, but that would be misleading. Actually, the average Swan owner finds the quarter kilowatt or half kilowatt transceiver very adequate for his operating needs. What the picture illustrates is some of the Swan accessories that will add more versatility and greater operating pleasure to your Swan station. For the DX operator, the model 508 external VFO provides separate control of transmit and receive frequencies, or for the MARS and Net operator, the 510X crystal oscillator provides up to 10 fixed channels. For breaking through those weekend QRM pile-ups there's no better cure, legally, than the Mark II Linear Amplifier with its 2000 watts of P.E.P.

## **S** TOP OF THE SWAN-LINE THE FAMOUS 500C TRANSCEIVER

520 watts P.E.P. input on 10, 15, 20, 40 and 80 meters. Finest crystal lattice filter with 1.7 shape factor. 1/2 microvolt receiver sensitivity. Voice quality, performance and reliability are in the Swan tradition of being second to none. **\$565**

## **S** MODEL 508 EXTERNAL VFO

Provides full coverage of 80, 40, 20, 15 and 10 meters in 8 ranges of 500KC each. Enables you to transmit and receive on separate frequencies. Plugs directly into either the 500C or 270. **\$145**

## **S** CRYSTAL CONTROLLED MARS OSCILLATOR

For Mars or Net operation. Model 510X. 10 channels. Plugs directly into 500C or 270. Less crystals. **\$55**

## **S** POWERHOUSE MARK II LINEAR AMPLIFIER

2000 watts, P.E.P. input, 10 through 80 meters. Uses two 3-500Z triodes. Complete with matching power supply. **\$660**

## **S** MODEL 117XC MATCHING AC SUPPLY FOR 500C TRANSCEIVER

For 117 volts, 50-60 cycles, with speaker and phone jack. **\$105**

## **S** 12 VOLT DC POWER SUPPLY FOR 500C TRANSCEIVER

Model 14-117, designed for mounting under hood. Includes cables, plugs and fuses. Can operate from 117 volt AC by detaching DC module and plugging in 117 volt line cord. **\$130**

## SWAN HORNET BEAM ANTENNAS

Latest addition to the Swan-Line. High quality, high performance antennas for the amateur bands. Best known are the famous Hornet Tribanders, made in 2, 3 and 4 element models. The TB-1000 series is rated at 2000 watts, the slightly smaller TB-750 at 1500 watts.

TB-1000-4 4 element . . . **\$159**

TB-1000-3 3 element . . . **129**

TB-750-2 2 element . . . **89**

TB-750-3 3 element . . . **109**



# SWAN

ELECTRONICS  
OCEANSIDE, CALIFORNIA

A Subsidiary of Cubic Corporation

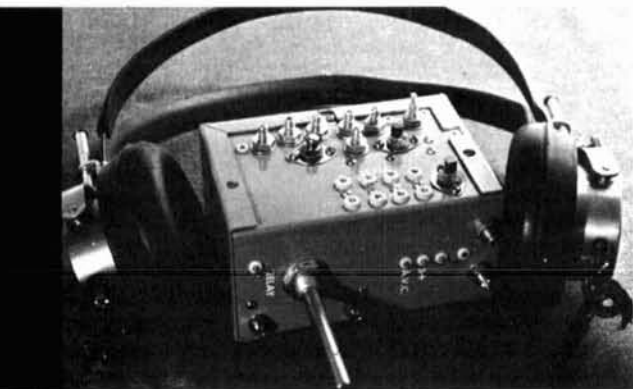

**second-  
generation  
fet converter  
for  
10 to 40 meters**

This bandswitching  
converter  
has improved stability  
and is much smaller  
than its prototype

Mike Goldstein, VE3GFN, 22 Kingswood Road, Toronto 13, Ontario, Canada

This 40- through 10-meter converter, was built as a design project for the 18th edition of the **Radio Handbook**.<sup>2</sup> Perhaps the most startling impression this converter offers is its small size. It would be difficult indeed to build a bandswitching converter covering this range into a smaller enclosure.

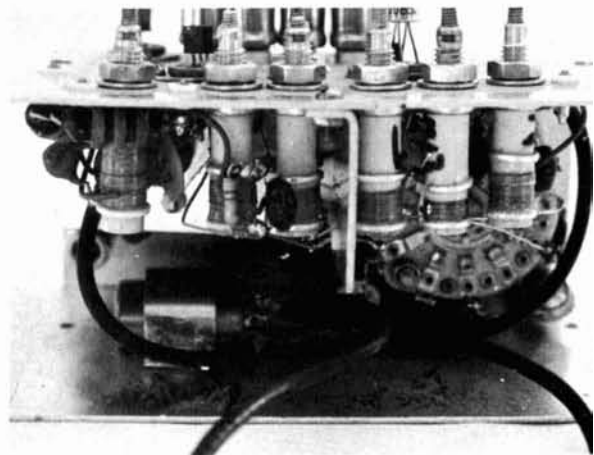

## design features

The design (fig. 1) was based on experience obtained from the previous model. This converter uses the simple bandswitching method of adding capacitance or inductance to a tuned circuit. An unneutralized rf amplifier is used, and no tuned circuits are switched in the oscillator.

The converter is less than one-quarter the size of its predecessor; however, it doesn't contain a power supply although it does contain its own change-over relay, which switches the antenna between converter input and input to the i-f strip. A dual-gate mosfet is used in the rf amplifier. This transistor has a feedback capacitance less than 0.03 pF, which means improved stability over the previous converter design.

The dual-gate transistor also allows this

through 10 meters and converts them to 80 meters merely by turning the bandswitch; no tuning is necessary. Input and output impedances are small, allowing the converter to be connected through random lengths of coaxial cable. Tuned circuits allow the complete 10-meter band to be covered, but only 500 kHz at a time, depending on the oscillator crystal frequency.

The rf amplifier is a common-source amplifier, unneutralized, designed basically as a 20-meter amplifier. To allow it to pass other bands, capacitance or inductance is switched across the tuned circuits. These tuned circuits have a 500 kHz bandpass on each band. On 10 meters, some loss in gain will be noticed if the 10-meter circuits are not retuned as crystals are changed to cover the different parts of the band. This method of bandswitching makes alignment very simple; only half the usual number of switch decks are necessary. Stability is assured by (1) using a transistor with a very small feedback capacitance, (2) using ferrite beads on amplifier input and output leads to reduce parasitic oscillation, and (3) eliminating amplifier tuning after initial adjustment.

The mixer is also a common-source amplifier: a jfet with both injection inputs applied to its single gate. This is a reliable and simple circuit. It's identical to that of the mixer in the original version.

The oscillator uses a bipolar transistor that has a rather interesting output circuit. Output impedance, offered by rf choke L4, increases in reactance as frequency increases. Output voltage is thus increased to compensate for any high-frequency losses.

The crystal for the 10-meter band will probably be an overtone type. A 24.5 MHz tuned circuit is included in the output to pick off the proper overtone. This tuned circuit is a short circuit at all but its resonant frequency. A similar tuned circuit was also included for 15-meter operation after initial tests indicated the presence of a 20-meter image. This circuit affects operation only when the oscillator is switched to 15 meters.

## construction

Because of its size, construction of the converter may appear difficult. However, it's

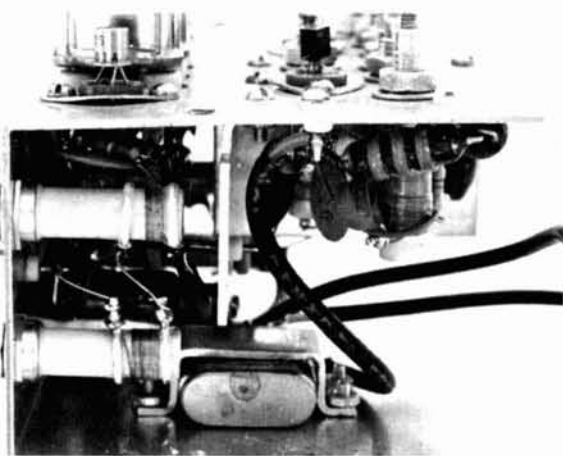

Layout of oscillator output coils and mixer stage. Note change-over relay on bottom lip. Also note Teflon feedthrough terminals on shield section.

converter to be controlled by agc voltage, which is supplied to the mosfet second gate. Minus 1 volt is sufficient to cut off the transistor. The converter is completely broadband; the necessity for peaking tuned circuits on each band has been eliminated. So, the construction of a "second generation model has been justified—better stability, easier operation, agc control and much smaller size.

The converter receives amateur bands

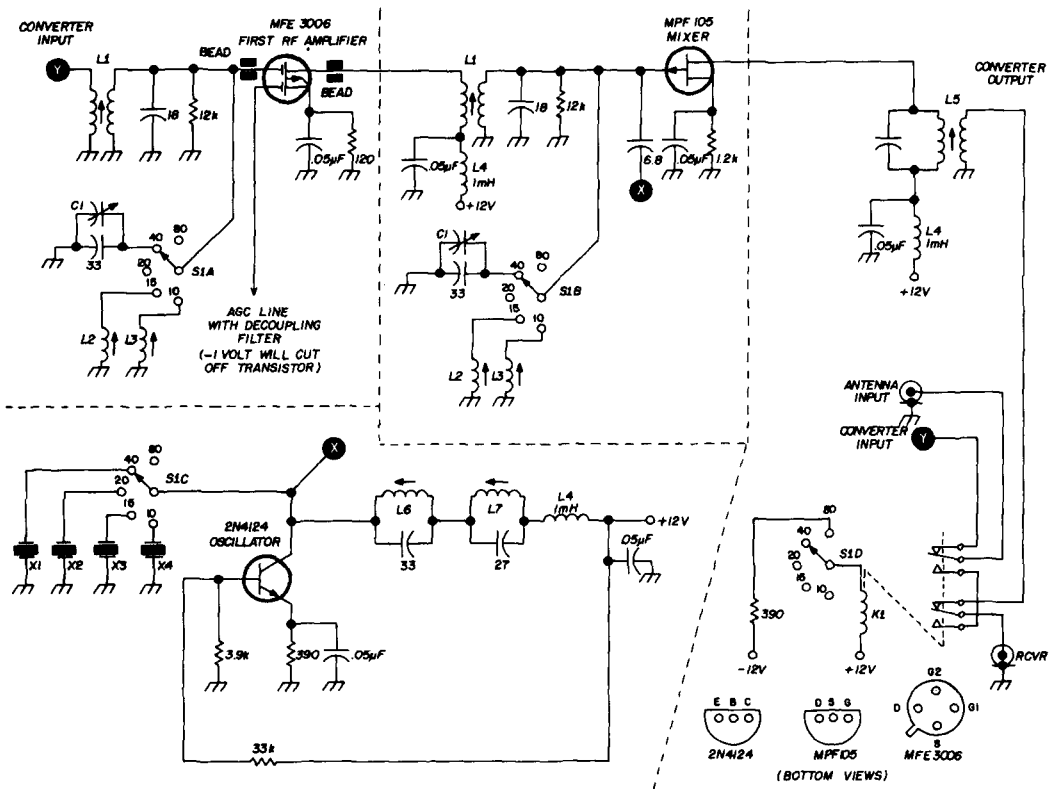

**C1** 10 - 60 pF piston (Voltronics TM-60C)

**L1** 24 turns no. 32 closewound on Cambion 2022-2 form 4  $\mu\text{H}$ ,  $Q = 50$ . Link is 5 turns on 32 on cold end

**L2** 20 turns no. 32 closewound on Cambion 2022-3 form 3.4  $\mu\text{H}$ ,  $Q = 50$

**L3** 11 turns no. 32 closewound on Cambion 2022-3 form 1.4  $\mu\text{H}$ ,  $Q = 50$

**L4** Rf choke, 1 mH, 35 mA (Superex M-10)

**L5** 40 turns no. 32 closewound on Cambion 2022-2 form 11  $\mu\text{H}$ ,  $Q = 50$ . Link is 10 turns no. 32 on cold end

**L6** 10 turns no. 32 closewound on Cambion 2022-3 form. Resonates with 33 pF at 24.5 MHz.

**L7** 15 turns no. 32 closewound on Cambion 2022-2 form. Resonates with 27 pF at 17.5 MHz

**S1** 2-section, 6-pole rotary switch (Centralab 2021)

**X1** 3.5 MHz crystal

**X2** 10.5 MHz crystal

**X3** 17.5 MHz crystal

**X4** 24.5 MHz crystal

fig. 1. Schematic of the second-generation fet converter. Dual-gate igfet rf amplifier allows improved stability and agc control.

one thing to look at the photographs and see many components crowded into a small space; it's something else to have an empty box into which must be wired some very small components. With care and planning construction should proceed quite smoothly. While the converter is easy to build, mistakes will be extremely difficult to correct. Each step should be carefully checked

before proceeding further.

The photographs show the layout. If time is taken to position components in each stage before wiring (including the shield partitions between stages) everything will fit quite neatly.

Looking at the photos, the three coils at the right rear are the rf amplifier coils; those at the left rear are the mixer coils. The



oscillator coils are at the front right, and the 40-meter piston capacitors are on either side of the bandswitch.

The photograph of the interior shows parts of the interstage shielding between the rf amplifier and the mixer. The change-over relay is mounted on the bottom lip of the converter. (This relay is from a military transponder and is about the size of a crystal; however, any dpdt relay that will fit will do.)

The rf amplifier should be wired first, after first drilling holes for all major components, including shields. The shields should be pre-shaped, and the push-in feed-through terminals should be installed before the shields are mounted. Each coil should be checked for continuity, and each tuned circuit should be grid-dipped as each bandswitch section is wired. This should be done before the transistors are plugged into their sockets.

A very small soldering iron should be used, with a low-melting-point solder. Very narrow needlenose pliers are a must.

Miniature coaxial cable is used to route the signals around the relay. Care should be taken not to overheat this cable during installation. To limit power drain, the relay draws power only when the bandswitch is turned to the 80-meter position.

## alignment

Alignment is quite simple and can be done without any instruments except a receiver. Switch the converter to 20 meters

and the receiver to the middle of the 80-meter band. Connect an antenna to the converter, and peak the 20-meter tuned circuits on a received signal, starting with the mixer. Switch the converter to 40 meters, and peak the piston trimmer capacitors for maximum received signal, mixer first.

Now to 10 meters. The alignment here is a bit more involved, as the mixer tuning and the oscillator tuned circuit will both

Rf-amplifier section. 40-meter piston trimmer is shown in front, next to bandswitch.

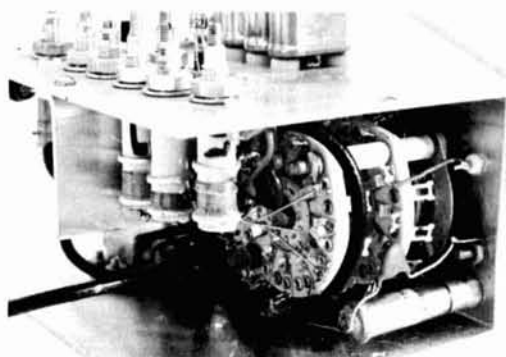

affect the output. Find the correct beat frequency first with the mixer coil, adjust the oscillator coil for a peak in signal, then adjust the rf amplifier for maximum output signal. Now switch to 15 meters, and repeat the 10-meter sequence with the 15-meter circuits. If any sign of a 20-meter image appears on 15 (an ssb signal will appear to be on the "wrong" sideband), adjust the 15-meter oscillator tuned circuit to reject the image.

This completes the alignment of the converter. As for your severe case of eye strain, you might consult the "ham notebook" item on page 67 of the August, 1969 issue of *ham radio*.

## references

1. M. J. Goldstein, VE3GFN, "Bandswitching Fet Converter," *ham radio*, July, 1968, p. 6.
2. W. I. Orr, W6SAI, "The Radio Handbook," 18th edition, 1969, Editors and Engineers, Ltd., New Augusta, Indiana 46263.

Four-band fet converter Mark II.

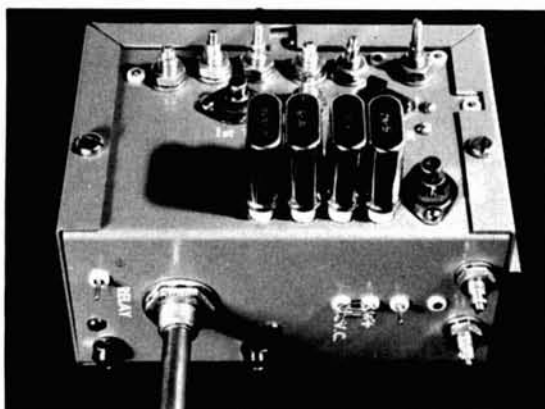

ham radio

# random-length antenna couplers

Solutions to the  
antenna-matching  
problem  
using proven  
switching circuits

With a few basic components you can build an antenna coupler that will couple a transmitter to almost any antenna length on any band. The key to this coupler is to use all the possible interconnections between the coupler components.

When using a random-length wire for an antenna, either in a portable or fixed station, the usual procedure is to build a pi-network coupler to match the antenna to a transmission line or transmitter designed to work into a fixed antenna impedance (usually 50-70 ohms).

The pi-network is capable of matching a wide range of impedances, including some reactive antenna loads, to a fixed-impedance transmission line or transmitter—once the proper component values for the network are determined. However, it's not always the most economical or efficient circuit, especially if a random length of wire is used on several amateur bands. Also, if the antenna wire length changes drastically, as in portable operation with unpredictable geographical restraints, the fixed pi-network can require considerable readjustment before proper antenna tuning results.

The problem is that one often tries to put too much flexibility into a circuit using components of a fixed (finite) value. Changing component values beyond their normal variable range is impractical. Therefore, the only other solution is to alter the circuit for greater matching flexibility.

John J. Schultz, W2EEY, 40 Rossie Street, Mystic, Connecticut 06355

This article explores the range of coupling circuits using up to three components (two capacitors and one coil or two coils and one capacitor). The variety of possible circuits will surprise those used to the familiar pi-network as being the only useful three-component matching network.

These circuits are presented as impedance-matching devices only. They vary greatly in

either an impedance step-up or step-down between antenna and transmitter or vice-versa may be necessary. Each circuit represents a specific matching network possibility.

The range of reactive impedances a circuit can match depends on frequency and the range of the variable components. Often it will be found that more than one circuit will easily match the same antenna load to a transmitter. Deciding on the best circuit is covered later.

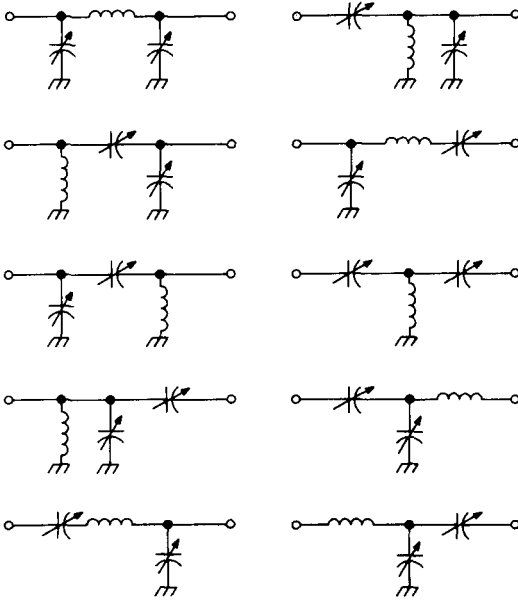

fig. 1. Matching networks that use one inductor and two capacitors.

their ability to attenuate harmonics (the pi-network ranks high in this category). However, assuming you have a reasonably harmonic-clean transmitter and are concerned only with coupling for maximum power transfer to a random-length antenna, many of the circuits should be very useful.

### circuits containing a single inductor

Fig. 1 shows circuits using a single inductor and two capacitors. Notice that some are simply others "turned around." They should not be disregarded, however, because

### multicircuit switching

An antenna coupler can be built with sufficient switching capabilities to use all ten of the possible combinations shown in fig. 1. All circuits except one can be constructed with one side of one of the variable capacitors connected to ground. This greatly simplifies construction since only one "floating" variable capacitor is required.

Fig. 2 shows a circuit that allows switching for 9 of the 10 circuits shown in fig. 2. Practical component values for a typical 80-10 meter coupler are also noted on the diagram. The switch has only 5 positions; the other coupler circuits are formed by reversing the coupler connections. Thus, for each switch position, the coupler has to be tried both forward and reversed. An internal reversing switch would probably be worthwhile for portable use where the antenna length or band is frequently changed.

### component ratings

The voltage rating of the capacitors, switch insulation, and coil depend a great deal on the use to which the coupler will be put. Transmitter power level and the range of antenna reactances are significant. The components in fig. 2 should work well with a 100-150 watt transmitter with almost any antenna length. For higher power, capacitors with larger spacing and a heavy coil will be necessary if very short antennas are to be matched without arcing. The cost of such a coupler, unless surplus components are used, can be very high for transmitters having more than a few hundred watts output. It might be better in this case to use a loaded antenna.

## construction

The construction of the coupler entails no particular precautions. Since harmonic attenuation is not a consideration, the coupler can be installed in a plastic container. This immediately solves the problem of ground-floating variable capacitors. The switch should be wired with the same size wire as the coil. Leads on the switch sections should be as short as possible. The wiring

wide range of impedance-matching capabilities can be made using the circuits of **fig. 3** if each inductor has a maximum value of 10-20  $\mu\text{H}$  and the variable capacitor has a range of 350 pF or more. This should permit matching a 16- to 20-foot or rod wire on 80 meters without difficulty. The cost of such a coupler can be fairly high if new commercial components are used. If you use surplus components, such as the capacitors and

**fig. 2.** Nine of the ten circuits shown in **fig. 1** can be formed with this circuit (the tee network with the two floating capacitors is the exception). Capacitors **C1** and **C2** are 250-pF air variables (Hammarlund MC-250-M); the inductor is a B&W 3900, 5 to 6 inches long, tapped with a spring clip.

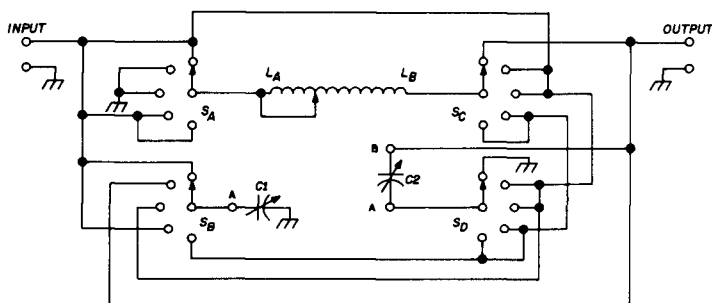

should present no problem if the scheme shown in **fig. 2** is followed.

## dual-inductor circuits

Matching circuits using two inductors and one variable or fixed capacitor are shown in **fig. 3**. These are the equivalent of the single-inductor, two-capacitor circuits of **fig. 1**, but they do have some different features.

With extremely short antennas (one-eighth wavelength or less), some of the **fig. 3** circuits will give superior coupling efficiency—provided the inductors have low ohmic losses. This is very important, as discussed below.

The high circulating currents in a network matching an extremely short antenna could be 20-50 amperes. This would produce serious  $I^2R$  losses. With a fixed antenna length, the only way to reduce these losses is to construct the coupler with components having the lowest possible losses for the frequencies involved.

Antenna couplers having an extremely

roller inductors in BC-191 and BC-375 units, very good couplers can be constructed at moderate cost. Alternatively, the inductors can be made from 1/8- or 1/4-inch copper rod or tubing to provide a 10-20  $\mu\text{H}$  inductance.

In any case, when dealing with extremely short antennas, I'd suggest a hard-wired interconnection of the coupler components rather than a switching arrangement. It's difficult, but all-important, to remember that with such an antenna you're dealing with very high currents with even a medium-power transmitter. With circulating currents of 40 amperes, for instance, it takes only **0.1 ohm** in the inductors or connections to the matching network to throw away 160 watts of power in heat loss.

The contact resistance of many simple switches exceeds this 0.1-ohm value, and this fact alone explains why many well-constructed couplers seem ineffective when used with extremely short antennas. (Mobile enthusiasts take note.) The advantage of low ohmic resistance components in a coupler

for extremely short antennas cannot be over-emphasized. That's why military couplers use oversized components for moderate power levels.

### tuning and adjustment

If you have only a pi-network available as an antenna coupler, the usual procedure would be to adjust it for minimum standing-wave ratio (swr). Indeed, this would be the

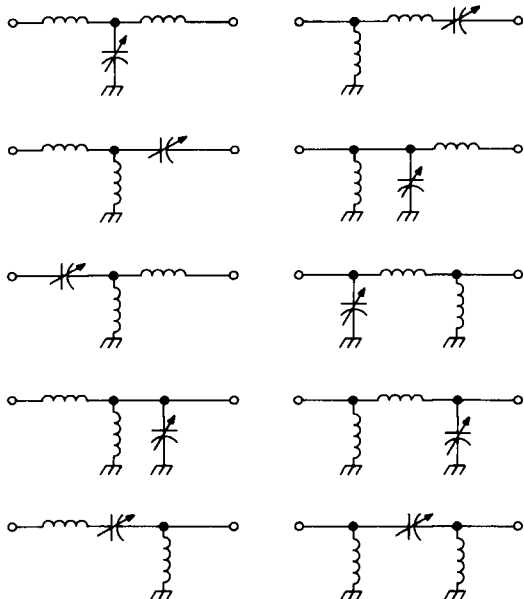

fig. 3. Matching networks that use one capacitor and two inductors.

only possible matching adjustment when tuning up a transmitter with a pi-network antenna coupler.

When using a coupler of the type in fig. 2 with random-length antenna wires (30 feet or more), note that several coupler forms on the same band might produce a minimum swr. In each case all coupler component values should be adjusted to achieve a minimum swr when the coupler is set for a specific circuit form. The same situation will often occur when using the coupler forms shown in fig. 3.

### swr and field strength

Minimum swr doesn't necessarily mean

maximum radiated power. Minimum swr can result from transmitter power completely transferred to the antenna, completely absorbed in the coupler network, or any condition in between. The only way to determine what is taking place is with a field-strength meter.

The field-strength meter should be placed away from the coupler's immediate field. It doesn't matter which coupler circuit is tried first, as long as the sensitivity control on the field-strength meter isn't touched once a reading has been established for a particular coupler circuit. Other coupler circuits should be compared against the first, which is established as a reference, until one is found that produces the greatest field intensity.

After you determine which coupler circuit produces the lowest swr with greatest field strength on a given band, you can log the coupler settings for changing bands quickly. The time spent in initial setup to determine the optimum coupler circuit with each different antenna or ground connection will be worthwhile.

The matching networks shown can be used on any band, but the unconventional types will find their greatest application on the high-frequency bands when used with odd-length antennas. For simple situations where an impedance match is desired and no reactive components are involved, a simple L or pi-network generally suffices. The latter circuit also has some harmonic suppression as well.

### grounds

A good ground connection is always desirable when using a random-length antenna, particularly if the antenna is less than a quarter wavelength long. In portable work, care should be taken to check the radiated field strength both with and without the ground connection. It's possible to have a ground connection that will actually reduce the radiated signal. You could lay a wire along the ground as a substitute for a radial system. In any event, the installation should be checked with a field-strength meter, as described above.

ham radio

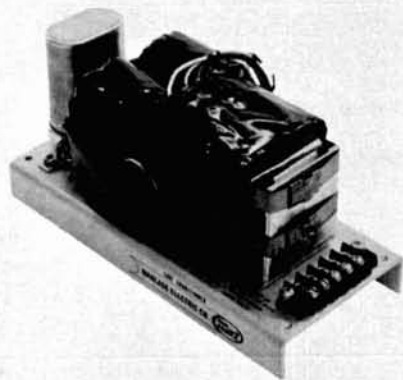

## power supply protection for your solid-state circuits

Many amateurs have learned, by unpleasant experiences, that transient voltage spikes and solid-state devices make a disastrous combination. A number of schemes have been advanced for limiting (if not eliminating) the deadly effect of even a moment's over-voltage. These vary from selenium clipping diodes to RC spike absorbers. Most work; some don't, which accounts for the thriving business in replacement diodes. Usually, the failure can be traced to omission of a precaution against an unexpected source of overvoltage.

A failure-proof device is now on the market, designed to give peace of mind to the user of solid-state devices. It's sold under the trade name Parafomer™ (derived from parametric transformer). A number of desirable functions are combined in this unique transformer. It will regulate changes in line voltage and changes in load. You can feed it sine waves, square waves, or waves with superimposed modulation; in each instance, the output is a sine wave (or nearly a sine wave). You can hit it with a voltage spike running into thousands of volts without affecting its sine wave output. It also attenuates (by 50 dB) all types of noise up to one megahertz. With the addition of electro-

static shielding (normally not required), its noise-reduction capability is effective far into the megahertz region.

### voltage surges

A significant feature is that turn-on and turn-off time is not instantaneous. Approximately 6 cycles are required for the voltage to build up from zero to 117 V and for the voltage to decay to zero when the input is switched off. Think what this means. No longer do you have to worry about elaborate circuits to sense when a waveform is passing through zero and break the circuit at that point. You can turn on a simple switch at any time with full confidence that the voltage will increase slowly enough to avoid any trace of a spike. Quite probably you can delete surge-limiting resistors between rectifiers and filter capacitors. At least the initial surge shouldn't be too drastic. What happens after that depends on how much of the charge you drain out of the capacitor between charging pulses.

### how it works

Conventional transformers used at power frequencies consist of two coils (primary and secondary) wound on a common core of

Carl C. Drumeller, W5JJ, 5824 N. W. 58 Street, Warr Acres, Oklahoma 73122

magnetic material. A current flowing in the primary creates a magnetic field consisting of lines of force (magnetic flux) that link with the turns of the secondary. If a load is connected to the secondary, the mutual inductance of the two coils will cause a voltage to be induced in the secondary.

The common transformer is a fairly efficient energy-transferring device, but it has one serious disadvantage. Because it operates on the principle of mutual inductance, it cannot discriminate between noise and transients appearing on the input voltage. It transforms noise and spikes just as efficiently as the applied voltage.

The Paraformer also has a primary and secondary coil wound on a magnetic core.

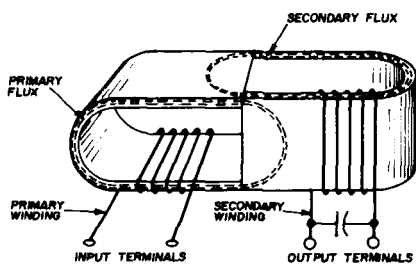

fig. 1. The Paraformer line conditioner. Cores are oriented at 90 degrees, eliminating mutual induction between windings. Resonant circuit is formed by LC of secondary, which is modulated, or "pumped," by primary flux forming a parametric oscillator.

But the big difference is that the Paraformer is designed to have zero mutual inductance between primary and secondary. This is achieved in a novel manner, as shown in fig 1.

The core consists of two elements positioned at 90 degrees with respect to each other. Note, however, that both coils share some of the common core material.

The opposition to flux linkage in a magnetic circuit is called reluctance. In the Paraformer, the reluctance of the secondary winding, and hence the energy transfer, is varied in a controlled manner. This is known as "pumping" the secondary. In fig. 1, note that the secondary coil and capacitor form

a parallel resonant circuit at some frequency,  $f$ . If the reluctance of the secondary, and hence the flux coupling, is varied at  $2f$ ; and if the pump frequency is **exactly in phase** with that of the input voltage; then a phase-locked oscillator results.

The energy supplied at  $2f$ , which pumps the secondary, controls circuit impedance in a manner to increase the power at  $f$ . The important difference between the Paraformer and other transformers, including the ferroresonant transformer, is that energy is transferred between primary and secondary at frequency,  $f$ , without transferring voltage spikes or noise that may appear on the input voltage. This is because energy transfer is obtained by a controlled input (pump) signal that's **phase locked** to the output. Thus output power is noise free and remains constant, even when input power momentarily drops out. Further details on the Paraformer are available in reference 1.

These line conditioners, as they're called, don't cost much more than an ordinary regulated power supply. But what a difference! For example, the PEC-60 (shown in the photo) has features unheard of in an ordinary regulated supply. Protection against over-voltage without external sensing devices is probably the most important feature for amateur work. If you carelessly plug it into a 220-volt line, its output instantaneously drops to zero. No blown fuses; no ruined transistor circuits. If power is continuously demanded by the load, output ceases, because the parametric oscillator won't function. Conversely, if input voltage is low, the parametric oscillator will not receive enough power to overcome circuit losses. Consequently, no oscillation will occur, and output voltage drops to zero. Between extremes of under- and overvoltage, the Paraformer continues to regulate at its design center.

#### references

1. Wanlass Electric Co., "Recent Technical Articles on Parametric Power from: EDN (Electrical Design News), Engineer/Scientist, Electromechanical Design," Wanlass Electric Company, 2175 South Grand Avenue, Santa Ana, California 92707

ham radio



# logarithmic speech processor

An addition  
to your phone rig  
that will increase  
average power  
by 8 dB  
without distortion

Many articles have been published describing speech clippers, rf clippers, automatic level-control circuits, and other methods of obtaining higher average transmitted power without creating spurious radiation. The speech processor described here also does this, but a different method is used.

The human speech waveform has a very low average-to-peak power ratio. The peaks are several times greater than the waveform's average amplitude, and the peaks are of very short duration. The power in these peaks is a very small portion of the waveform's total power because of the short durations of the peaks. If we can in some manner control the peaks to increase the average-to-peak ratio in the waveform, we will add little distortion and much power to the transmitted signal.

At this point, I suppose I could become involved in the argument between high-fidelity and communications-quality enthusiasts, but I won't go into that now. Let me say that the speech processor described here can be adjusted to suit almost every taste in signal quality and will, in every case, increase the average transmitted power.

## speech clippers: pro and con

Most speech and rf clippers work on the same basic principles. When the speech or rf waveform exceeds a predetermined amplitude, the remaining waveform is clipped from the output. This system has been used

Lee M. Richey, WA3FTY, RD 1, Franklin, Pennsylvania 16323



in many commercial and home-built transmitters, but it has two disadvantages. First, the clipping level is usually fixed. This means clipping varies with how loud you speak into the microphone. This can have a drastic effect on the amount of distortion in the output. When speaking loudly into the microphone, the average amplitude may exceed the clipping level. Thus, most of the speech intelligence is eliminated from the waveform. This makes the signal loud but very difficult to copy.<sup>1</sup>

The second disadvantage is that harmonic distortion is created by clipping. Since clip-

fig. 1. Basic circuit of the logarithmic speech processor. A high-gain amplifier provides a current source to drive a pair of diodes connected back-to-back.

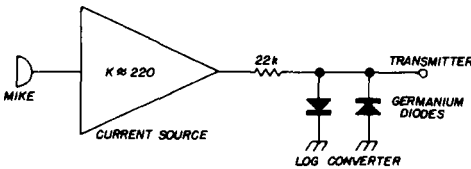

ping results in an abrupt change in the rate of rise of the speech waveform, many odd-order harmonics are generated. The clipped portion of the waveform resembles a square wave, and a perfect square wave contains an infinite number of odd harmonics of the fundamental frequency.

These harmonics can cause an excessively wide signal. They can be eliminated by a low-pass filter at the clipper output, but this adds to the size and cost of the unit. Filter-type single sideband transmitters limit the transmitted signal bandwidth automatically, but the problem of the fixed clipping level remains.

Both of these disadvantages can be eliminated by the logarithmic speech processor, which eliminates the abrupt change in the waveform and eliminates the problems caused by the discrete clipping level.

## the logarithmic converter

With this system, the waveform's average-to-peak ratio is increased by the logarithmic

conversion of the speech waveform. Its output voltage is proportional to the logarithm of the input voltage. Thus, the abrupt change in the waveform is eliminated, because the log conversion is continuous and smooth. No specific clipping level predominates to cause harmonic distortion. The basic circuit is simple and can be used with am, fm, or ssb transmitters without filters or other accessories (fig. 1). Logarithmic conversion is accomplished with a current source and a pair of germanium diodes. The characteristic curve for a common small germanium junction diode, the 1N34A, shows a smooth logarithmic response on voltage versus current (fig. 2).

## operation

The voltage across the diode is proportional to the log of the current through it, so a current source is necessary. This is a high-gain voltage amplifier, which drives the

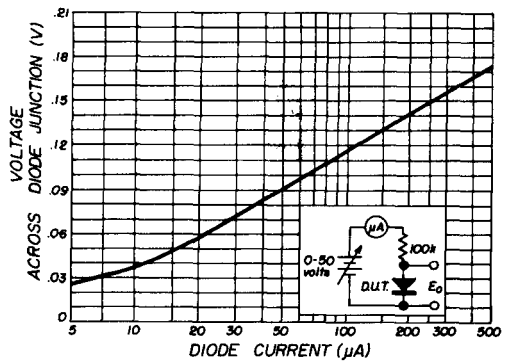

fig. 2. Curve for a common germanium diode (1N34A). Logarithmic transition of output voltage versus input current is smooth and continuous.

diodes through a high resistance. The amplifier output is about six volts p-p. With a 22 kilohm series resistor, this represents about 360  $\mu$ A p-p available to the diodes. One diode conducts during the negative half cycle, and the other conducts during the positive half cycle, so each diode shares half of the p-p current.

Fig. 2 shows that the voltage across each

diode at 180  $\mu\text{A}$  will be about 137 mV for a total output of 274 mV p-p. This is more than enough audio to drive most transmitters.

### the circuit

The high-gain amplifier consists of an fet source follower input, for high impedance,

leads are inserted through the holes, bent over, and soldered on the opposite side, printed circuit fashion (fig. 5). As with all high-gain, low-level circuits, leads should be kept short and direct; and input and output leads should be shielded as well as those to the log-linear switch.

The transistors shown on the schematic

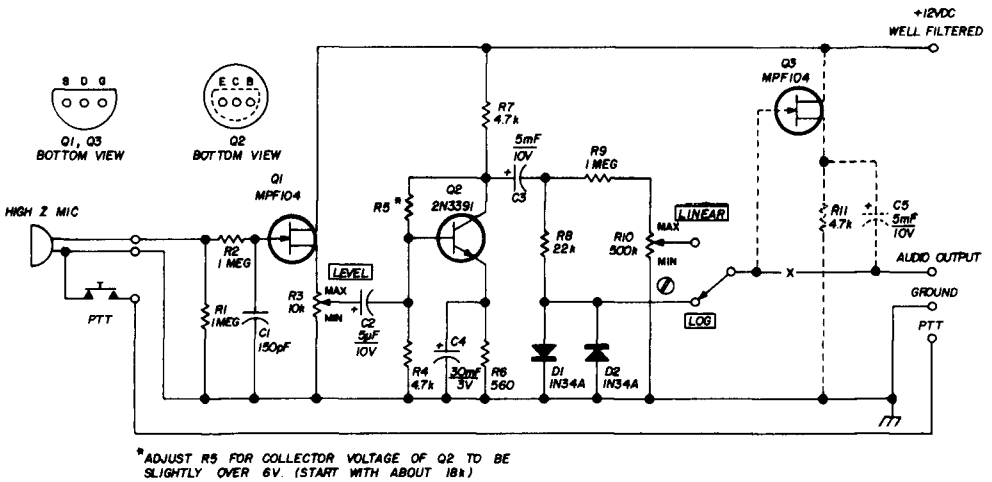

fig. 3. The logarithmic speech processor schematic. An fet source-follower output circuit (dotted lines) is recommended for use with low-impedance input equipment.

and a common emitter amplifier, fig. 3. Output may be taken directly from the 1N34A's if the processor is to be used with equipment having high impedance input (250 kilohm or greater). If the circuit is to be used with low-impedance equipment, such as the SB-34 transceiver, a source follower output circuit (dotted lines, fig. 3) is recommended.

Power can be borrowed from other equipment, or it can be supplied by a battery. Power requirements are 9 to 12 Vdc at 10 mA. Very smooth dc is required. If necessary, the filter shown in fig. 4 may be used for additional filtering.

### construction

The unit shown in the photographs was constructed on "Micro Vectorboard," which is a G-10 epoxy glass board with 0.042-inch holes spaced on 0.1-inch centers. Component

were used because of their low noise characteristics. Others may be used, of course, but keep in mind that the voltage gain of the circuit is over 200, and noise could be a problem with poor transistors. The unit shown in the photo was mounted behind a control panel with some other equipment, but there is no reason why it couldn't be mounted in its own small enclosure or within the transmitter or transceiver.

fig. 4. Filter circuit for source voltage to ensure low ripple content.

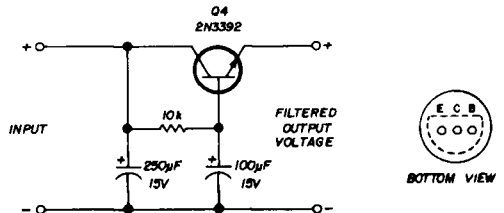

## adjustment

After completing the wiring, but before mounting the unit, apply power and adjust the value of R1 until the collector voltage of Q2 equals slightly greater than one-half the supply voltage. After mounting the unit in its enclosure, set the switch to the **log** position and the two potentiometers to their **min** positions.

fig. 6. Oscilloscope traces showing part of the word "hello". Upper trace shows waveform normally fed to transmitter; lower trace, after log conversion, shows an 8 dB increase in average-to-peak ratio.

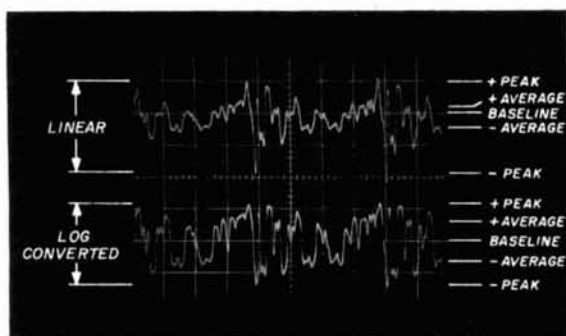

Probably the best way to set the level control is to connect the output of the processor to a high-fidelity amplifier and listen through a pair of earphones. While speaking

fig. 5. Perforated board layout. Component side is shown in A; wiring side in B. Points x, y and z go to the linear-log switch.

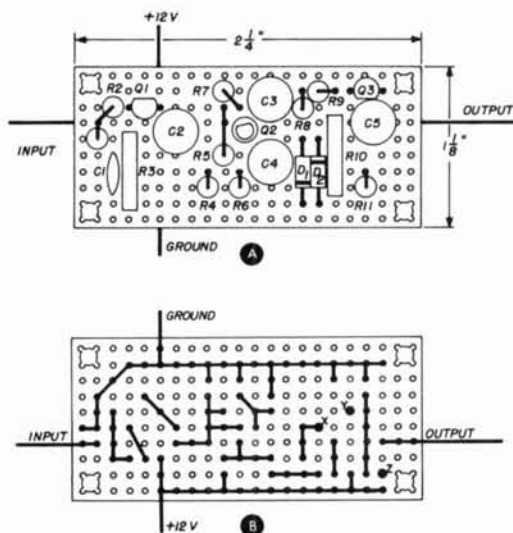

into the microphone, adjust the level control until the distortion just becomes objectionable. Turn the control back slightly, and you should be all set to go. Turn the switch to **linear** and, while talking into the microphone with the same loudness as before, adjust the linear control to approximately the same loudness or slightly less.

Now connect the processor to your trans-

mitter microphone jack, and adjust the microphone gain control for proper transmitter operation. If you have a general purpose oscilloscope available, check the waveform at the collector of Q2 to be certain that this stage isn't flat topping. If it is, lower the level control slightly. If a high-fidelity amplifier and an oscilloscope aren't available, you'll have to depend upon on-the-air reports to find the proper level-control setting. The linear control should be set after the level control has been set, and the linear control should be adjusted for proper transmitter operation.

## operation

The plate meter of our transmitter should indicate a higher average current with the processor switch in the **log** position than in the linear position. Yet, the peak output as observed on a monitor scope should be no greater. (Caution should be observed, when operating near the legal power limit, not to exceed 1 kw dc plate power input.) The linear position bypasses the log conversion, and operation is normal in this position.

This unit works equally well with transmitters with and without alc. In sideband rigs with alc, it allows higher average plate current before the alc circuit takes control. In rigs without alc the processor allows higher average plate current before flat toping. In am and fm equipment it allows a higher average percentage of modulation, without overmodulation, and it does all this without any noticeable distortion.

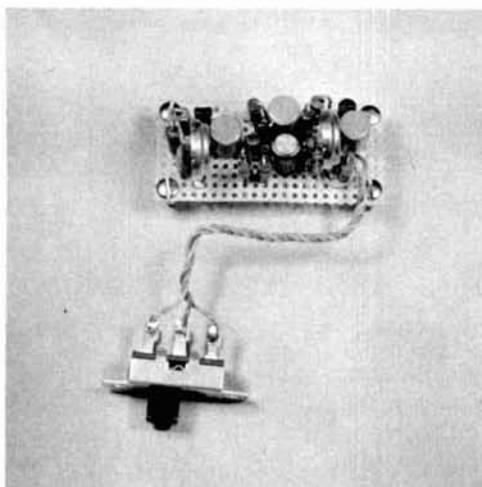

Top view of finished speech processor ready for mounting. The switch in the foreground is the "linear-logarithmic" switch. Input to the circuit is at the left side; output at the right.

### some final thoughts

As with all such devices in this class, it must be remembered that since the average-to-peak ratio has been increased, the signal-to-noise ratio is lowered. Hum and noise in the microphone wiring, room noise, fans, blowers, and other extraneous noise will modulate the transmitter more than before. Therefore, care should be taken with regard to microphone wiring, placement and use.

This speech processor has been in operation for over six months now and has given good service. It has been used with an SB-34 transceiver barefoot with 65 to 70 watts dc input. I have been able to hold my own in

competing with much higher-powered equipment and the audio reports have all been favorable.

### test results

The oscilloscope traces of **fig. 6** offer dramatic proof of what can be achieved with **controlled** speech processing. Both traces show the waveform of a portion of the word "hello." The upper trace shows that the

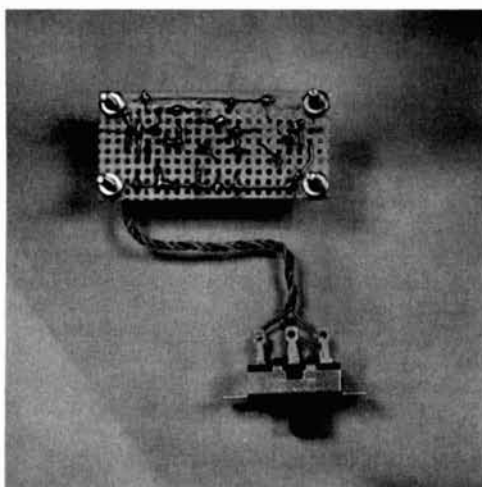

Bottom view of the speech processor. The wire leads of the components are inserted through the circuit board, bent over the leads of other components, and soldered together to produce the unit.

average-to-peak ratio is about 1:5 for both positive- and negative-going voltages. The lower trace shows the same waveform after **logarithmic conversion**. Notice that the average-to-peak ratio is now about 1:2.

The improvement in average-to-peak voltage ratio, after log conversion, is 2:5. This represents an **8 dB** increase in average power, and this does not include distortion products!

### reference

1. E. H. Conklin, K6KA, "To Clip or Not To Clip?" *ham radio*, April, 1969, p. 24.

**ham radio**



**A HANDSOME PAIR  
MATCHING  
BOUND VOLUMES and BINDERS  
FOR YOUR  
HAM RADIO COLLECTION**

<b>Binders</b>	<b>\$3.95</b>
<b>1968 Bound Volume</b>	<b>\$14.95</b>

All Prices Postpaid

---

**HAM RADIO MAGAZINE  
GREENVILLE, N. H. 03048**

# proportional temperature control for crystal ovens

Design data  
and a practical circuit  
to ensure  
precise thermal control  
for crystal oscillators

When building high-stability crystal-controlled oscillators, it's necessary to ensure that the crystal operates at a constant temperature. One of the best ways of doing this is to put the whole oscillator inside a tin can and bury it somewhere. The ambient temperature five or six feet underground is remarkably constant. This method is excellent if you're prepared to put up with the inaccessibility, near impossibility of repair, and the problems associated with drilling holes in your walls.

Putting the crystal in a small electrically heated oven, regulated by a thermostat, has none of these disadvantages. Such ovens often can be found in junked or surplus equipment. However, thermostats are rarely adjustable, so the oven temperature is governed by whatever gods look upon surplus emporiums. The thermostat contacts carry all the heating current and therefore tend to get dirty and arc after much use. This causes noise, which may get into other equipment through the heating-current line.

Also, the temperature in these ovens varies cyclically as the heating element is alternately turned on and off. This causes a small periodic variation in oscillator frequency, which may be undesirable in critical applications.

## proportional temperature control

A proportional temperature control is one in which the heating current is varied smoothly under the control of a temperature sensor. The current is never switched entirely off or on, but is left on continuously; as the temperature rises toward the desired level, the current decreases. Finally, a situation is reached where the current is just sufficient to maintain the temperature at a constant value. If the outside temperature decreases, the controller increases the current until equilibrium is again reached.

J. A. Koehler, VE5FP, 2 Sullivan Street, Saskatoon, Saskatchewan, Canada

Normally a thermistor is used as the temperature sensor and is connected to an amplifier that controls the heating element. There is, however, a simpler way that makes use of the leakage current in transistors and which is highly temperature dependent, so that a transistor may be used as the sensor.

### the circuit

Fig. 1 shows a circuit that takes advantage of this principle. Q1 is a leaky germanium (Ge) pnp transistor and is the temperature sensor. Q2 is an amplifier, and Q3 is the heating element. Q3 is a power transistor

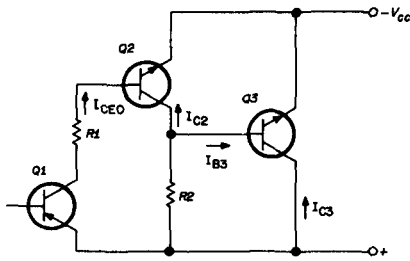

fig. 1. Proportional temperature control circuit. Q1, a leaky germanium pnp transistor, is the temperature sensor; Q2 is an amplifier, and Q3 is the heating element.

able to handle the required heating current. To ensure that the heat generated by Q3 is distributed evenly throughout the oven, Q3 should be fixed to the oven walls if they are metal, or to a strip of metal extending throughout the oven if it is not metallic.

This circuit provides a simple, inexpensive, and precise way of controlling temperature. Perhaps the greatest advantage of the circuit is that it may be easily analyzed and may therefore be used to design a controller for virtually any desired temperature. In fact, for a given set of transistors and  $V_{cc}$ , the temperature is determined only by the value of R2.

### analysis

Q1's base is floating, so its collector current is  $I_{ce0}$ .  $I_{ce0}$  is very dependent on temperature. For Ge transistors, it increases by

a factor of ten for a temperature increase of 55° F.

Suppose you measure  $I_{ce0}$  at room temperature (70° F) and call the measured value  $I_1$ . Then  $I_{ce0}$  at any other temperature, T, will be

$$I_{ce0} = I_1 (10)^{\left(\frac{T-70}{55}\right)}$$

This current is fed to the base of Q2, so the collector current,  $I_{c2}$ , of Q2 will be determined by the common emitter current gain,  $\beta_2$ , of Q2 by

$$I_{c2} = \beta_2 I_{ce0} = \beta_2 I_1 (10)^{\left(\frac{T-70}{55}\right)}$$

Q3's collector current,  $I_{c3}$ , is determined by Q3's beta,  $\beta_3$ . Its base current,  $I_{b3}$ , is determined similarly, so that  $I_{c3}$  is equal to  $\beta_3 I_{b3}$ .

Now, if Q2 were not connected to the base of Q3,  $I_{b3}$  would be determined by resistor R2 and would be approximately equal to  $V_{cc}/R2$ . However, Q2 draws some current, so the current available to Q3's base is only

$$I_{b3} = \frac{V_{cc}}{R2} - I_{c2}$$

Substituting the value of  $I_{c2}$  determined previously into this equation and multiplying it by  $\beta_3$  yields the collector current to Q3:

$$I_{c3} = \beta_3 \left[ \frac{V_{cc}}{R2} - \beta_2 I_1 (10)^{\left(\frac{T-70}{55}\right)} \right]$$

Assume you've connected the circuit and apply  $V_{cc}$  when the components are at room temperature. At that time,  $T = 70^\circ \text{ F}$ , so  $I_{c3}$  will be

$$I_{c3} (\text{initial}) = \beta_3 \left[ \frac{V_{cc}}{R2} - \beta_2 I_1 \right]$$

The power dissipated by Q3 at that instant will be the product of  $V_{cc}$  and this initial current. As the temperature rises,  $I_{c3}$  will decrease; eventually the temperature will reach some final value,  $T_f$ , where the heat dissipated by Q3 is just enough to balance the heat losses. At this point,  $I_{c3}$  will be

so small compared to its initial value that we can approximate it to zero. Then

$$\frac{V_{cc}}{R2} = \beta_2 I_1 (10) \left( \frac{T_f - 70}{55} \right)$$

This equation may now be used to calculate the value of R2 that must be used for the final temperature,  $T_f$ , of the oven. Fig. 2 is a nomograph of equation 2. To design an oven controller for any temperature, simply calculate  $V_{cc}/\beta_2 I_1$  for the transistors you intend to use, and use fig. 2 to obtain the value of R2.

R1 is used to limit the dissipation of Q1. The leakage current in Q1 will cause some heating of the junction. If Q1 is to sense the temperature inside the oven, its dissipation should be as small as possible. A safe value of R1 is a value of kilohms equal to  $V_{cc}$  in volts. For example, if  $V_{cc}$  is six volts, R1 should be at least 6 kilohms. Q2 and Q3 should be silicon (Si) transistors. If they are Ge, the final temperature will end up somewhat lower than the design value, since leakage in Q2 will decrease in the base current available to Q3.

In an extreme case Q2 may even run away thermally and turn Q3 completely off (and perhaps burn out Q2). However, for temperature less than about 125° F, Ge transistors will perform satisfactorily. In any case, Q2 and Q3 must be the same type; either Ge or Si.

### measurement considerations

Uncertainties in the measured values of  $\beta_2$  or  $I_1$  cause surprisingly little effect in the final temperature. For instance, if your measured values of either  $\beta_2$  or  $I_1$  are in error by a factor of two, the final temperature will be within about 16° F of the design value. If you need a specific and precise temperature, make R2 variable and adjust it to get the desired temperature. Before building the circuit, use equation 1 to calculate the initial collector current of Q3 to ensure that it does not exceed the rated maximum for the transistor. If it does, you'll have to use a heftier transistor.

I used this circuit to control a small oven for the clock in a digital counter I'm building. The oven is about 1 × 1 × 2 inches.

The design temperature was about 100° F. since the temperature here seldom exceeds that value. Q1, which is of uncertain origin, is a pnp Ge transistor in a TO-5 case.  $I_1$  is 20  $\mu$ A.  $V_{cc}$  is 12 volts, so R1 is 12 kilohms. Q2 is a silicon planar transistor (probably one of the 2N3704 family). It has a measured beta of 140. Q3 is a TIP-24, with a measured beta of about 80. R2 is 1 kilohm.

Substituting these values into equation 2 results in a predicted final temperature of 102° F. The measured final temperature was

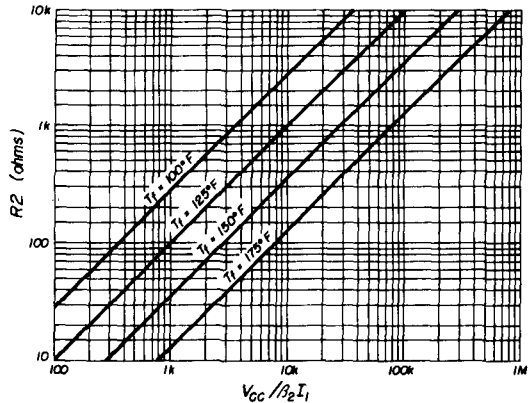

fig. 2. Value of R2 as a function of  $V_{cc}/\beta_2 I_1$ .

100° F. The measured initial current, at room temperature, was 0.9 ampere; whereas the calculated value was 0.8 ampere. Once the oven had risen to its final temperature, the current required to keep it there was less than 0.1 ampere.

### construction notes

It's important to keep the oven as small as possible. Heat losses depend upon the surface area of the box, so if you increase the size by a factor of two, heat losses will go up by a factor of four. The oven should be insulated with a layer of styrofoam or similar material around it. A 1/2-inch-thick layer is usually sufficient. Make sure that Q3 is in good thermal contact with the oven wall, since you're relying on thermal conduction to distribute the heat around inside the oven. Put Q1 as close as possible to Q3, preferably in contact with it; otherwise the oven will take a long time to stabilize and may even oscillate in temperature.

ham radio



*New Readers*

WE'VE BEEN LOOKING  
FOR YOU!

*we hope you've been looking for*



Here is an exciting new amateur magazine devoted to the very best in home construction and technical articles. This is the magazine which has amateurs from coast to coast talking.

Look it over carefully. Read the finest authors in our field. See the clean crisp new layout. Can you afford to be without the **best magazine** in amateur radio today?

**ham  
radio**

*magazine, greenville, new hampshire 03048*

Please enter my subscription to **Ham Radio** as checked below.  
My check or money order is enclosed.

- One Year \$6.00  
 I'd like **one year free.**  
Here is \$12.00 for 3 years.

Name..... Call.....

Address.....

City..... Zip.....

# ssb converter

for  
432 MHz

Five watts  
of ssb power  
with this circuit  
outperforms a-m  
on the long hauls

How would you like to reach out and work some of those hard-to-get stations on 432 MHz? The answer to extending your DX range is single sideband. Also, if you like to build your own equipment, this mode offers a challenge that's hard to pass up.

The 432-MHz converter described here delivers five watts to the antenna. That's a pretty respectable amount of power at this frequency, considering that the converter was built, for the most part, from "junk-box" components. The only expensive items were the 6939 tubes. The performance of the converter has certainly justified the cost of these tubes. Many stations were worked that just couldn't be contacted with the same power on a-m.

## circuit description

The converter is driven with a six-meter ssb signal; 29 MHz could be used by changing the crystal string to provide 403-MHz output. Obviously, this would require a small amount of coil pruning in the stages. Type 2C51 (5670) tubes and a 6J4, purchased from surplus, make up the crystal string and provide sufficient injection to the 6939 mixer. Two stages operate as doublers and two as grounded-grid amplifiers (fig. 1). The 382-MHz signal is link coupled to the mixer grid circuit, because direct coupling between the 6J4 and 6939 tank circuits would require a very long chassis or some sort of double-decking arrangement.

Resistors are used instead of rf chokes to feed the B-plus to the mixer and linear amplifier plate tank circuits. Rf chokes caused spurious radiation and unstable operation in these stages.

All filament, B-plus and bias wiring is on top of the plated epoxy boards. Feed-through capacitors deliver these voltages to the converter stages. This minimizes stray coupling between stages.

Jim Brannin, K6JC, 424 Anson Avenue, Rohnert Park, California 94928

A separate voltage-regulated power supply was necessary to obtain stability in the 95.5-MHz oscillator during modulation. Voltage regulator tubes in the main power supply just wouldn't do the trick.

### construction

The aluminum chassis is 10 x 14 x 3 inches, with two sections cut out to accommodate the two epoxy boards. The cutout for the crystal-strong board is 9-3/4 x 3-1/4 inches; the mixer-amplifier cutout is 11-3/4 x 3-3/4 inches. The boards are 10-1/2 x 3-3/4 inches and 12-1/4 x 3-3/4 inches respectively. Tube sockets, tank circuits, coils, etc., were located for best coupling between stages.

Parts should be placed to obtain the very shortest leads. The input and output circuits of V2, V4A and V5 should be separated by copper shields, extending ap-

**Above-chassis construction of the converter. The oscillator and multiplier stages are on the smaller board to the rear; mixer and power amplifier are in the front.**

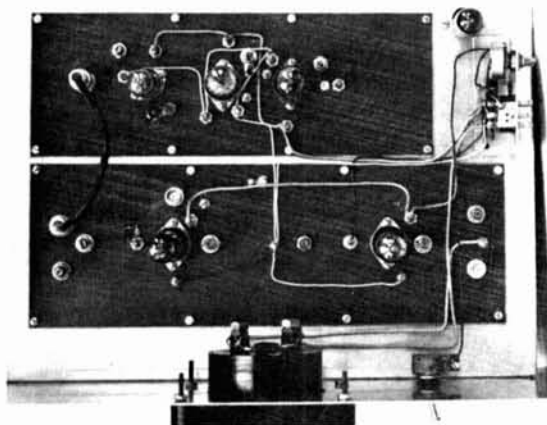

proximately 2 1/4 inches down from the bottom of the boards. The circuit might operate satisfactorily without these shields; however, room should be left so they can be added later if required.

A 3 x 1-3/4-inch aluminum bracket supports the six-prong Jones male receptacle and bias potentiometer as shown in the upper right hand corner of the photo. The OC5 regulator tube in the oscillator pow-

er supply is mounted on the edge of the chassis beside this bracket. The standby switch is on the right side of the plate milliammeter on the front panel. The 6.3-V filament transformer, diode rectifier, filter capacitor, etc., are mounted directly beneath the bracket.

The 3/4-wave mixer grid input hairpin, L2, is bent up at 90 degrees as shown in the coil data. This is necessary so that the

**Below-chassis view shows component layout and construction of tuned lines.**

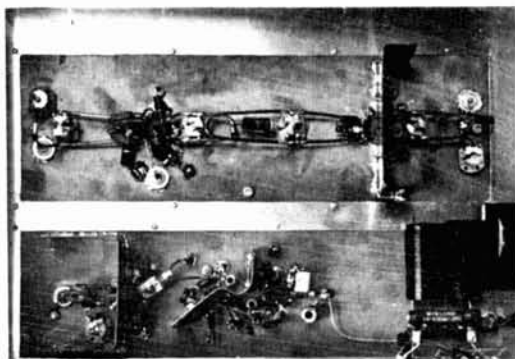

mixer and amplifier stages can be mounted on the 12 1/4-inch epoxy board.

### testing and adjustment

If the coils and loops are made according to the dimensions in the coil and tank-circuit data, little or no pruning should be necessary. A grid-dip oscillator is very helpful. If a grid-dipper is used, the adjacent loop or coil should be wrapped with metal foil, otherwise two resonance indications may be noted unless both circuits are, by chance, tuned to the same frequency.

Tuned-circuit resonance can be checked with a vtm equipped with an rf probe. Each stage can be checked for maximum drive by coupling fairly closely, either by a two-turn coil or a 20-pF capacitor fastened to the tip of the rf probe. The coupling can be reduced for final adjustment.

When the crystal string is operating properly, the output at the BNC connector should light a number 47 lamp to about half brilliance. The rf probe can be used

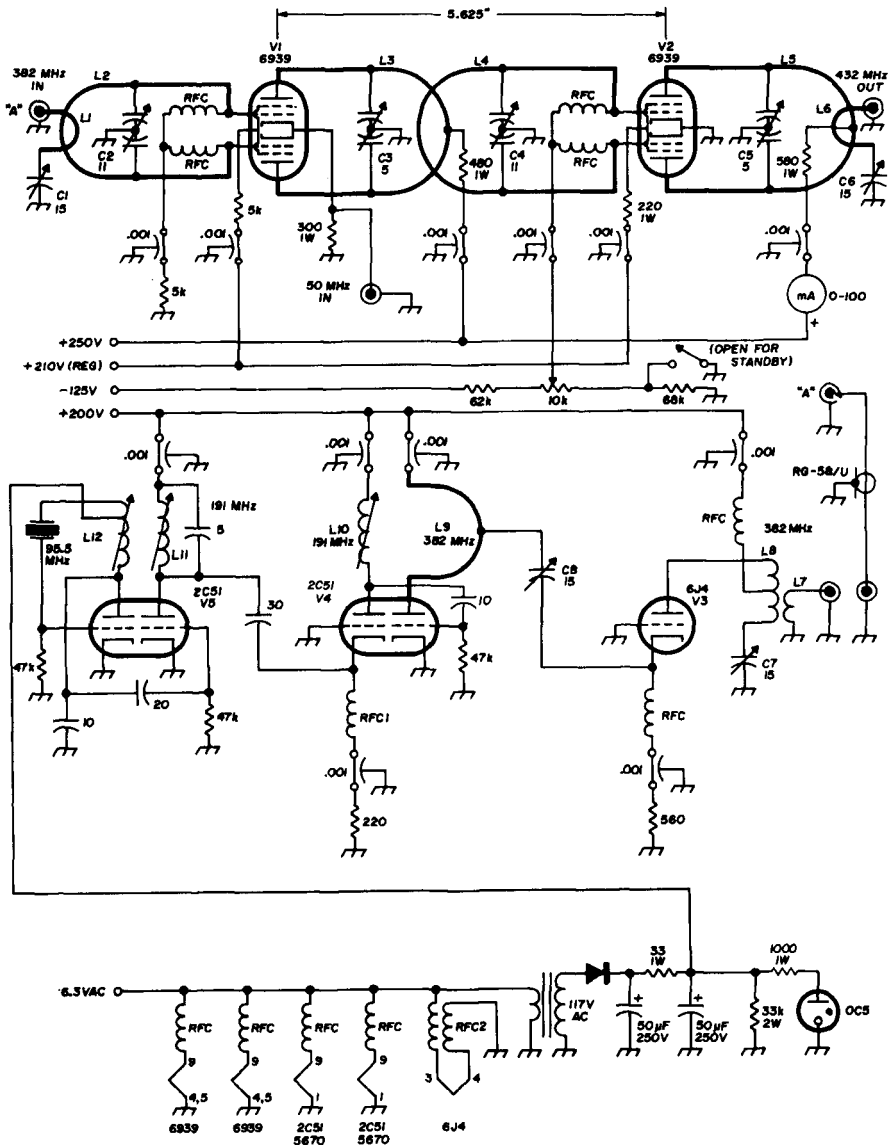

- |        |  |   |   |
|--------|--|---|---|
| C1, C6 | 15-pF miniature variable   | L10, L11  | 3 turns no. 24 on 3/16" slug-tuned coil form, 5/16" long                                |
| C7, C8 | (Johnson 160-107)  | L12   | 6 turns no. 24 on 1/4" slug-tuned coil form, 5/8" long, tapped 2 turns from crystal end |
| C2, C4 | 11-pF butterfly (Johnson 160-211)                                  | RFC1  | 20 turns no. 24 on a 5k, 1W resistor  |
| C3, C5 | 5-pF butterfly (Johnson 160-205)                                   | RFC2  | 2 coils; each 8 turns no. 24 bifilar wound on 1 W resistor                              |
| L7     | 2 turns no. 18, 1/2" diameter, lightly coupled to L8               | All other rf chokes are Ohmite Z-460 or equivalent. |   |
| L8     | 2 turns no. 18 bare, spacewound, 5/8" diameter, 5/8" long          |   |   |
| L9     | hairpin loop, 3/4" long, 5/8" wide at ends, C8 connected to center |   |   |

fig. 1. Schematic diagram of the 432-MHz ssb transmitting converter. Coils L1 through L6 are shown in fig. 2.

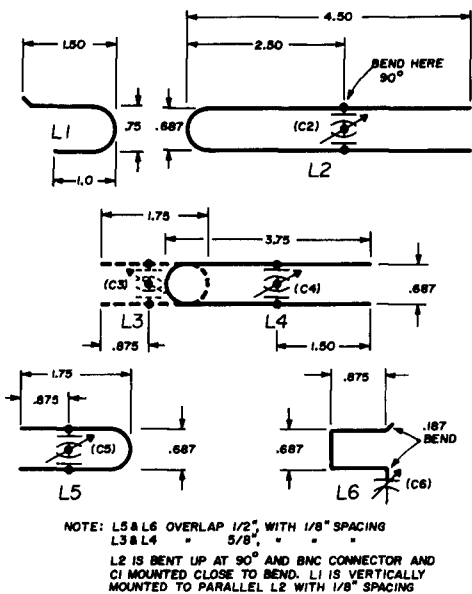

fig. 2. Construction of the coils for the 432-MHz transmitting converter.

on the mixer plate tank for preliminary adjustment of input and output circuits of this stage. Plate current in the final will indicate proper adjustment of the 6939 grid loop. Also it's the best indicator for final tuning of all stages in the converter. The final plate current should be approximately 70 milliamperes when the converter is properly tuned and adjusted.

If a thru-line wattmeter is not available, a forward-power indicating device should be installed in the coaxial cable to the antenna. This can be a piece of enamelled magnet wire sewn beneath the coax shield for about three inches, located fairly close to the antenna change-over relay. The end toward the antenna should be connected to a small diode and bypassed; the other end should be terminated with a 50-ohm resistor. A 0-500 microammeter or 0-1 milliammeter can then be connected and operated remotely for convenient viewing.

The converter described here has required no retuning or adjustment for several months, and its performance has been most gratifying.

ham radio

# RCA has all-new FCC commercial license training

Get your license—  
or your money back!

Now RCA Institutes Home Study Training has the FCC License preparation material you've been looking for—all-new, both the training you need, and the up-to-date methods you use at home—at your own speed—to train for the license you want!

**2 Convenient Payment Plans**—You can pay for lessons as you order them, or take advantage of easy monthly payment plan. Choose the FCC License you're interested in—third, second or first phone. Take the course for the license you choose. If you need basic material first, apply for the complete License Training Program.

**SPECIAL TO AMATEURS.** This course is primarily for Commercial License qualifications. But it does cover some of the technical material that will help you prepare for the new Advanced and Amateur Extra class tickets. Check out the information the coupon will bring you.

Mail coupon today for full details and a 64-page booklet telling you how RCA Institutes Home Training can show you the way to a new career—higher income—and your FCC License.

# RCA

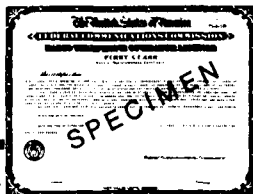

RCA INSTITUTES, INC.  
Dept. 350-001-0  
320 West 31st Street, New York, N.Y. 10001

Please rush me, without obligation, information on your all-new FCC Commercial License training.

Name \_\_\_\_\_

Address \_\_\_\_\_

City \_\_\_\_\_ State \_\_\_\_\_ Zip \_\_\_\_\_



## use your magazines

Most of us  
collect  
technical magazines,  
and there they lie  
unused on the shelf;  
this article  
gives some good tips  
on how  
to keep them alive

I have finally solved the problem of what to do about all my old electronics magazines, but it takes courage. It's simple: you take all the new and old copies of the magazines you have, carefully extract the articles that interest you, and throw the rest away! Admittedly, you may change your tastes in future years, but this is better than burying all the articles in a relatively unavailable form in anonymous but attractive rows of magazines. A book in hand is worth two in the bookcase.

### how?

Carefully take the staples out of magazines like **QST**, **Radio-Electronics**, or **Electronics World**, and tear out noteworthy articles. Make sure you include any "continued-on-page-108" items. Most other electronics magazines don't have staples directly through them, so you can tear out each article directly. "Perfect-bound" (i.e., glued-together) magazines like **ham radio** should be folded as flat as possible at the relevant page before tearing out.

E. L. Foster

Once you've torn out an article, staple the pages together at the upper left corner if there's more than one sheet. Carefully put them into a Manila folder and invent a suitable title. (The choice of titles is important and will be covered later.) A title such as "Transmitters" is a lot more useful than "Transmitters—complete—80M — 6 tubes—2 diodes," for example.

### why?

It makes sense. Out of the monthly deluge of information you receive, if you need to know something you merely look up the appropriate folder and it's there. My method also has the advantage of forcing you to read the articles, even if briefly. Space is also saved by eliminating chatty columns and ads.

Sometimes I wonder if the one or two articles I get from a magazine are worth the cost of that issue. For the most part, they are. **QST** is worth saving because of its occasional gems, and the **ARRL** is worth supporting. **Radio Communication** is worthwhile because of items such as "Technical Topics," and because the **RSGB** is also worth supporting.



### the file cabinet

If you don't have a filing cabinet, the folders can be kept in a cardboard box. The box can be on an inconspicuous shelf, because you'll only refer to it when you're going through current magazines or when you need information. Or you can select magazine covers with unusual designs and colors, trim them to make a pleasing arrangement, then glue them to the sides of the box (known to artistic types as a collage). Give the box several coats of clear lacquer. This reinforces the box.

My storage and retrieval method also works well for old issues—and you'll be amazed to discover the many excellent and useful articles on all manner of subjects. The thrill of this discovery has kept me at this task: five magazines to shred every day until they are all done. It's cheaper to reduce your magazines in this manner than to build new bookshelves to accommodate the growing pile of literature. (Some take the easy way out and merely sell the whole lot after X years.)

The system I use is different from that in which you bind back issues of magazines. These techniques<sup>1,2</sup> are valuable for binding books, but they have no place in a Magazine Shredding Program. They merely codify the situation but don't solve it. It's rather unproductive to bind a book permanently, 90 percent of which is useless and takes up valuable space, and 10 percent of which you'll never bother to consult because you don't know where it is.

### the system

What do you do if you have two good articles that have been published back-to-back? First decide which is the most interesting. This is the article that should remain complete. There are several cases of this situation, in which:

1. **The less-interesting article starts on the back of the good one.** Write the title and subject briefly at the top of the second page of the amputated article, indicating where the rest of it is filed (fig. 1).

2. An article ends on the back of the good one. Write on the bottom of the last available page of the amputated article, "continued on..." or "see... file" (fig. 2).

3. A good article is sandwiched between two others. Make out a full-sized sheet of paper showing title, subject, and where the two halves may be found. Then file the paper instead of the article.

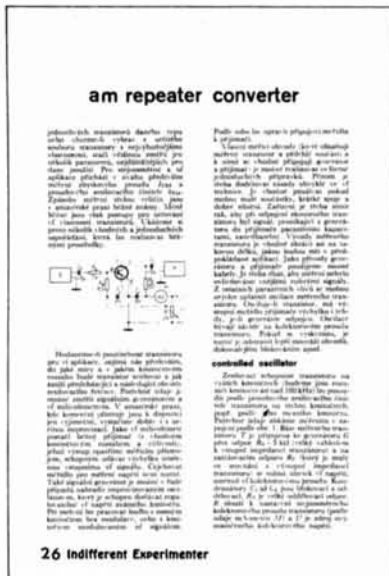

fig. 1. First two pages of less interesting article. Interesting article, "Advantages of FM Over SSB," ends on page 25. The more important article is filed under "Modulation, FM," but a note of it is entered under "SSB Controversy."

4. Two good articles are to remain together. Write the title of the second article on the front page of the first, and file a descriptive sheet of paper as in 3 above.

5. Rare publications that don't print name and month of issue on each page. Examples: Break-in (from New Zealand) and Autocall. Use abbreviations such as BI 7/67 or AC 7/67.

6. A single article that contains a wide variety of good designs. Examples are G3VA's "Technical Topics," which appears frequently in Radio Communication; "Hints & Kinks" in QST; "Noteworthy Cir-

cuits" in Radio Electronics. The hard way to find these articles is to make a separate sheet of paper for each subject and file it in a "collections" file. Sometimes this requires as many as fifteen separate listings for one month's worth of "Technical Topics" and could be more work than you'd want.

Nothing is worse than a good filing sys-

tem that's not followed, so an alternative must be sought. One way is to file the relevant articles in the "Collections" file for six months. However, you should read them thoroughly each month and make special note of points you may need in the future. Then go back over them, and pick out items according to subject.

You may have the same fifteen or twenty pieces of paper to file under different headings, but each piece will refer to several articles in which a given point is mentioned. For example: one sheet of paper labelled "Transistorized Transmitters" could refer to specific subarticles in four or



five issues of "Technical Topics." I dwell on this problem because it can be frustrating but it is important enough to devise methods for solving it.

### classifying the data

In general, file an article according to the subject, not necessarily the title. Sometimes authors can be misleading in their effort to be clever; editors should never al-

cause they are a dime a dozen in the literature.

### data retrieval

There is a definite temptation to keep some items intact, such as "Miniwatt Digest" (Philips) and the like, but such temptation should be resisted, even if attractive binders are provided—which you may already have. Filing away blocks of ar-

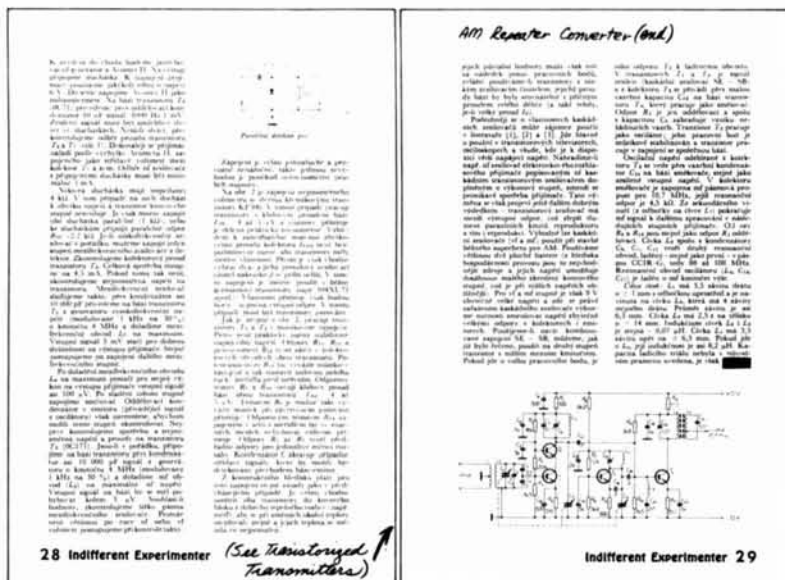

fig. 2. Last two pages of an uninteresting article. Good article is on page 30.

low this! A recent article bore the title "The Thing"—Transistorised (sic), an Experimental Sideband Exciter," but the subjects were principally crystal frequency alteration, a bandsread oscillator, an electronic sweep generator and some very interesting data on the use of ordinary rectifier diodes as varicaps. In the next issue the author did indeed get down to sideband, but you would never know it from this one. In this case, I filed it under "diodes, varicap," but I filled out a separate sheet of paper to refer to the article and filed it under "crystals," and another under "oscillators, sweep." I didn't pay any attention to the ordinary oscillator be-

ticles in binders is only justified if you know what's in them. Always ask yourself, "If I do this, can I get my hands on the information when I need it?" If the answer is yes, **any** filing system is satisfactory. My system is more practical than most, once you get over the horror of the magazine-shredding process.

For a really effective filing system be sure to save the table of contents from each fractured magazine. A cryptic notation can be written in front of each title to show where it was filed, though this is not usually necessary. The table of contents can help where a title might be ambiguous or misleading, or when you are re-

ferred to an article by another reference. If I read the **Journal of Indifferent Electronics**, and it refers me cryptically to "QST, May 1907, p. 31," the only cure is to dig out the relevant table of contents (which I have filed under "index") and see what it was all about.

The system I describe here is the best of several I've tried. It is crude, but much more effective than any elegant indexing arrangement using file cards or punched cards. The reason is simple: you are more likely to use my system and keep on using it. It's destructive, but what is more useless than a complete set of magazines you never use? Yearly indexes? Nearly useless: the magazine's indexing system is likely to overlook subjects that interest you, but which may be buried in another subject. For example, a good point on transmitter or receiver design may be included in a review of some uninteresting piece of commercial equipment. And let's face it, most commercial "amateur" equipment is uninteresting if it's just a box with knobs.

Advertisements may also be filed by this method if you need them for reference, but you can always get current ads featuring current items. Therefore, don't tear the current issue apart until the next one arrives. Have a definite place to store "magazines to be shredded", and never let the pile get higher than one-half inch!

### what to do about arrl handbooks

An unexpected bonus of the "shred-it-yourself" approach happens in the treatment of the ARRL Radio Amateur Handbooks. As you know, this text appears each year, and well over 50 percent is unchanged from one year to the next. This is where the shredding technique appears at its best. You simply go through the current issue and the previous one simultaneously, page-by-page. This sounds like a lot of work, and it is, but it doesn't take too long.

Since it doesn't usually matter which issue you keep intact, the simplest arrangement is to choose the older issue, or the first one that changed from glossy to dull paper (1962). Then all subsequent issues are torn apart, until about the fifth-year

later. In about five years, ARRL handbooks usually change enough to warrant keeping one intact. Then all subsequent ones are referred to it.

### the technique

You have the choice of discarding whole sections, or going through likely sections page-by-page to see where they may have substituted one item for another—usually a whole paragraph. The page-by-page method is simplified considerably by comparing the diagrams; if a section has been altered, a new (or absent) diagram will appear, and will become immediately evident by comparison with the old copy. But if you don't want to go to all this work, you won't be too far wrong if you delete a whole section. You may miss a few interesting items. In this activity a considerable hidden benefit evolves because you are forced to review the entire contents of a text, however casually, and you will be fascinated to discover all manner of useful and interesting things from it.

1. From the newer edition you will want to discard completely or in part the chapters on:

- Amateur Radio (one is interesting, but is quite sufficient)
- Electrical laws and circuits
- Vacuum tube principles
- Power supply
- Amplitude modulation or audio amplifiers & dsb phone
- Specialized communication systems
- Antennas
- Wave propagation
- Vhf antennas
- Construction practices
- Interference with other services
- Operating a station—and similar chapters

You must keep one of the editions intact so that you can reread the history of amateur radio if some beginner asks you about it. Save the newest issues and shred only previous ones. The whole subject came up as I contemplated the great stack of ARRL handbooks that had reached the end of

available shelf space. I had purchased one every couple of years on principle, even though I hadn't even opened some of them.

2. You'll want to preserve the construction sections of the following chapters and discard the theory sections, if any. Always save the first page of each chapter, at least, to make it easier to locate:

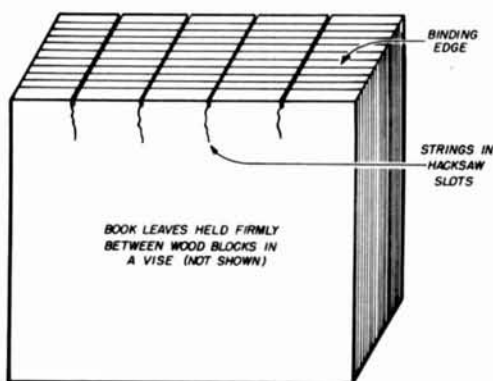

**fig. 3. Simplified bookbinding.** It's wise to put the wooden blocks as close as possible to the binding edge. Use waxed paper between the wooden blocks and the book.

High-frequency receivers  
High-frequency transmitters  
Keying and break-in  
Speech amplifier and modulators  
Suppressed-carrier or single-sideband phone  
Transmission lines  
Vhf receivers and transceivers  
VHF transmitters  
Mobile equipment  
Measurements  
Assembling a station  
Vacuum tubes and semiconductors; keep the whole chapter because they have a tendency to delete useful older types.  
Index: keep all

Some years change more than others. For example, as I recall, there were only about a half-dozen pages in 1964 different from 1963; but 1967 was quite different from

1964—115 pages or 15 percent of the total.

## removing handbook pages

The method of extracting pages may depend on the number to be removed at any one time and on the binding. In older editions the binding was firmer, reinforced by string, and pages will be more difficult to remove than from the newer ones. You have the choice of using a razor blade or carefully tearing a page out from its binding. The tearing method is more practical for whole groups of pages or a whole chapter. Lay a steel rule along the gutter and tear gently.

You should be reasonably careful when extracting pages or sections, because if the alteration to an issue is not too drastic, the decimated issue can be given to a beginner, who will be able to make good use of the theory portions. For this reason, I suggest that when you remove something from an edition, you note carefully on the margin of the previous page the name of the item you've removed; if the recipient is actually interested, he can always dig it up from other sources, e.g., you.

The extracted sections will be added to the reference issue (the oldest one). The best way to do this is to insert relevant material at the end of the chapter related to its subject, in the reference edition. I admit this will result in a somewhat looseleaf arrangement, but it shouldn't matter too much if you're careful. You may not look at it too often anyhow, and when you do, you need only exercise some care in keeping the right pieces together. The problem of increased bulk will be met by the fact that you will have been able to discard the whole advertisement section.

When the requisite editions have been removed in this manner, you can solve the looseleaf problem neatly by binding them together. You can take it to a professional bookbinder and have him do it; the cost won't be much. But it's not difficult to do it yourself if you follow the methods suggested below.

## binding the handbooks

The binding method I prefer is simple

and adequate. (Other material on bookbinding appears in reference 3.) First carefully line up all loose sheets with the fixed ones. Then line up the left-hand edges. If you have a bookbinding shop in your town, the bookbinder will cut the edges in his power-driven cutter. You might also consult your local librarian about this service.

With the edges held together in a vise,

**fig. 4.** Place a piece of waxed paper between front cover and first page, and another between back cover and last page. Close it all up, place another book on it for pressure, and allow to dry for another day.

The result will be a neat looking and functional book, and sturdier than most of the ones you buy. The glue should be the special white liquid bookbinding type be-

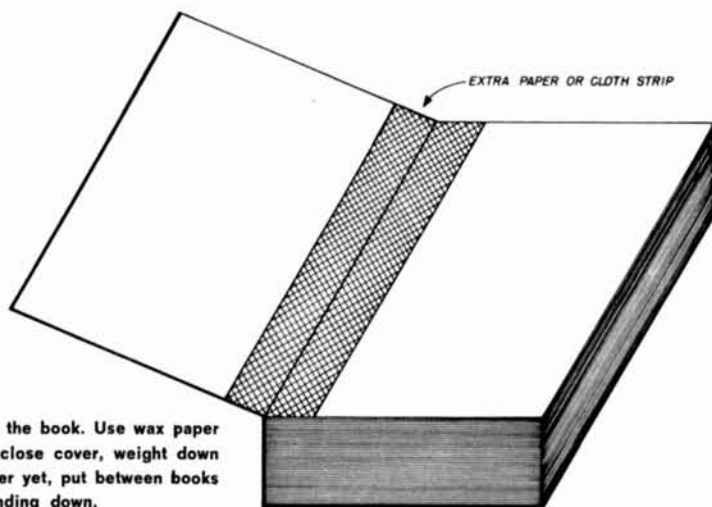

**fig. 4.** Putting a cover on the book. Use wax paper between cover and book, close cover, weight down with another book, or better yet, put between books on the bookshelf with binding down.

make about ten V-shaped cuts with a hacksaw at right angles to the binding, about 1/16-inch deep. Then lay a piece of string in each cut, leaving the ends dangling, as shown in **fig. 3**. Cover the whole binding with glue, spreading it evenly, preferably with a finger, but being very careful not to allow any to slop over any edge. When tacky, lay a piece of linen cloth (as from a sheet) on the binding edge and carefully apply glue all over it. Allow to dry for a day or so, then carefully slice away all dangling cloth and string with a razor blade. Glue the cover to the binding, again being careful not to slop any glue onto the edges of the pages. Apply a one-inch strip of paper or cloth to the point where the cover meets the first and last pages of the book, as shown in

cause it's very adhesive and flexible. If you can't find it, ordinary white wood glue will suffice. The bookbinding glue is rather expensive, but worth buying, because you'll find it useful in repairing other books, particularly where the publisher has economized on the quantity or quality of the binding.

#### references

1. J. Kirk, W6DEG, "Make the Most of Magazines, and have fun doing it," 73, December, 1966, p. 70.
2. R. Gunther, VK7RG, "Editorial," *Australian EEB*, August, 1967, p. 110.
3. P. W. Waters, G3OJV, "Bookbinding for the Amateur," *RSGB Bulletin*, December, 1966, p. 802.
4. R. A. J. Reynolds, VK7ZAR, "The 1968 ARRL Radio Amateur's Handbook—A Critical Review," *Australian EEB*, December, 1968, p. 130.

ham radio



## **NCX-1000**

### **1 Kw Solid-State Transceiver (80 thru 10 Meters)**

Here's a transceiver designed for the amateur who would rather spend his hard-earned radio dollar on performance than frills. The NCX-1000 is built to meet the demands of the operator who needs and desires a high performance SSB-AM-CW-FSK rig with solid-state dependability and plenty of power. Add to this the convenience of having your transmitter (including linear amplifier), receiver, power supply, and monitor speaker in a single, compact, smartly styled 59 pound package.

So let's look at the NCX-1000, starting with the double-conversion, solid state receiver. After the received signal is processed by a double-tuned preselector, a stage of RF amplification, and another preselector, it is applied to the first mixer for conversion to the first IF frequency. The first IF contains passband filters and a stage of amplification. A second mixer then converts the signal to the second IF frequency for additional processing by a 6-pole crystal-lattice filter and four IF stages. Finally, the signal is detected and amplified by four audio stages. The unparalleled high dynamic range lets you tune in weak stations surrounded by strong interfering signals. The result? High performance for SSB, AM, CW, and FSK. Sensitivity of 0.5 EMF microvolt (for a 10 db S+N/N ratio).

In the transmitter you'll find three stages of speech amplification followed by a balanced modulator, a crystal-lattice filter, a filter amplifier, and an IF speech processor (clipper). A mixer converts the signal to a first IF frequency for processing by two crystal passband filters, and two IF amplifiers. A second mixer converts the signal to the transmitting frequency where it is amplified in five RF stages before it gets to the grid of the 6BM6 driver. Final power amplification takes place in a forced-air-cooled 8122 ceramic tetrode which feeds the antenna through a pi network. Other features? You bet! Grid block keying for CW. Complete metering. Amplified automatic level control (AALC).

So here's a package that can give you 1000 watts PEP input on 80 through 10 meters, 1000 watts on CW, and 500 watts for AM and FSK. The speech processor lets you double your SSB average power output with minimum distortion. No frills with the NCX-1000. Just top performance.

Write for complete details.

 **NATIONAL RADIO COMPANY, INC.**  
**NRCI**

111 Washington Street, Melrose, Mass. 02176

617-662-7700

# NEW

# 18<sup>th</sup> edition of THE WORLD FAMOUS Radio Handbook

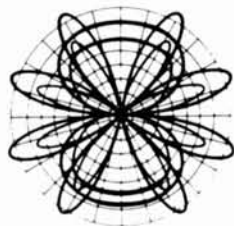

Only

**\$13.50** postpaid

\* The biggest selling book for the amateur and engineer market!

\* Thoroughly revised and updated!

Over 800 pages tells how to design, build, and operate the latest types of amateur transmitters, receivers, transceivers, amplifiers, and test equipment . . . SSB Equipment . . . RTTY Circuits and Semiconductor Circuits.

**Provides a Complete Understanding of:**

- Circuits of newest development
- Test equipment
- Antennas
- Radio Mathematics
- Industrial and Military electronics

ORDER TODAY

from

book division

**comtec**

Box 592 • Amherst, New Hampshire 03031

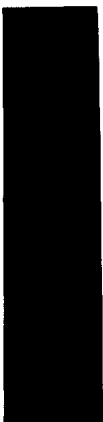

# unidirectional antenna

for the  
low-frequency  
bands

End-fire and  
broadside characteristics  
are combined  
in a steerable array  
using a  
simple switching circuit

Malcolm M. Bibby, GW3NJV, 2748 Juno Place, Akron, Ohio 44313

Rotary beams for 40 meters are too large for the average garden of the European amateur or for most American amateurs' backyards. Many aspiring DX operators who want to work below 7 MHz have tried some form of vertical antenna because of its low vertical radiation angle. Generally what happens is that, after the initial excitement has passed and the DX operator starts the hard work of chasing countries using an omnidirectional antenna, he starts thinking of ways to eliminate noise and interference from locals. To put it mildly, a single vertical antenna isn't too well known for this. The books don't give much help, so if the DXer wants to compete at all he must rely on basic principles and good old amateur ingenuity.

## there is a way

One of the simplest forms of directional antenna systems is the spaced vertical two-element array.<sup>1</sup> The radiation pattern for such a system fed in phase and spaced one-half wavelength apart is shown in **fig. 1**. The beamwidth at the half-power points is 60 degrees.

If one of these elements is fed 180 degrees (one-half wavelengths) out of phase with respect to the other, a horizontal pattern appears as shown in **fig. 2**. The half-

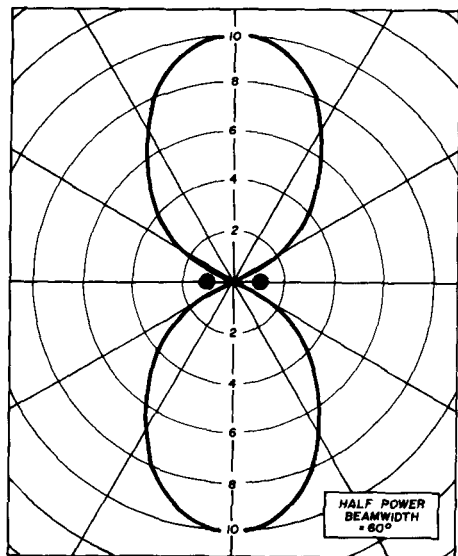
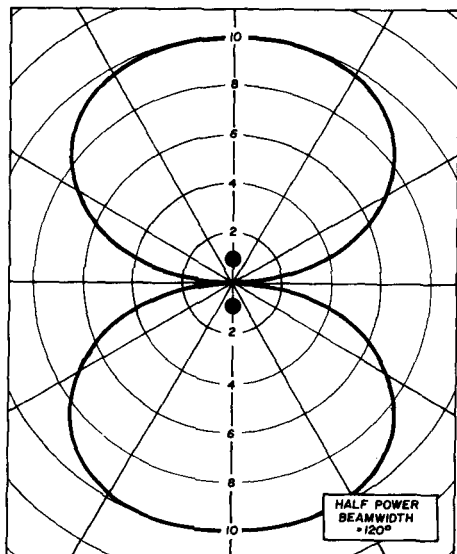

fig. 1. Horizontal pattern for two V elements spaced one half-wavelength and fed in phase.

power beamwidth is 120 degrees. Both systems are bidirectional, which is an improvement over the single vertical antenna. Such systems, or a variation of them, have been used by many amateurs.<sup>2,3</sup> However, the problem with either arrange-

fig. 2. Horizontal pattern for two elements spaced one-half wavelength and fed 180 degrees out of phase.



ment (broadside or end-fire radiation) is that they are bidirectional and have different bandwidths depending on their phase relationships. This is fine for broadcast service, for which they're primarily used, but broadcast stations don't work DX in the crowded amateur bands.

When the spacing between the two elements is reduced to one-quarter wavelength, the phase difference is reduced by 90 degrees. Then the pattern of fig. 3 results. The beamwidth is 180 degrees, but a unidirectional pattern has been obtained that can be switched to cover two directions. The beamwidth is as broad as the side of a barn, though. The question is, can anything be done to improve it using simple techniques? Yes, indeed. Read on.

### a solution

By using four vertical elements and the principles of the systems whose patterns are shown in figs. 1 through 3, a unidirectional system can be obtained having a half-power beamwidth of 88 degrees. It can be made steerable in four directions by simple switching methods.

Consider the four vertical elements of fig. 4. Elements 1 and 3 are spaced one-

fig. 3. Horizontal pattern for two elements spaced one-quarter wavelength and fed 90 degrees out of phase.

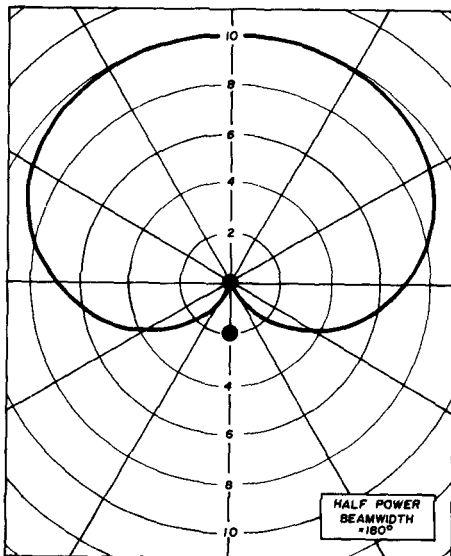



half wavelength. Element 3's phase leads that of element 1 by 180 degrees. Both produce the horizontal patterns of **fig. 5A**. Elements 2 and 4, also spaced one-half wavelength, have the horizontal pattern shown in **fig. 5B**. So far it seems nothing has been gained. However, when elements 2 and 4 are fed with their phases advanced by 90 degrees with respect to element 1, the two lobes in the upper part of **figs. 5A** and **5B** will add, while the two

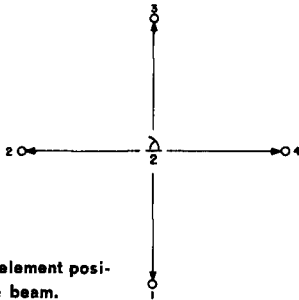
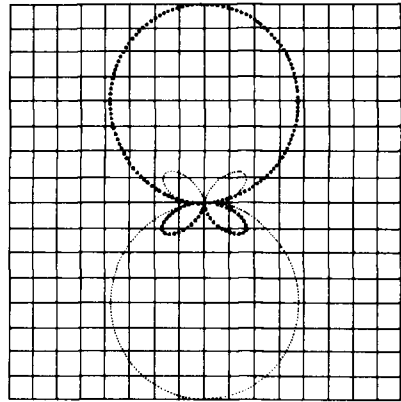
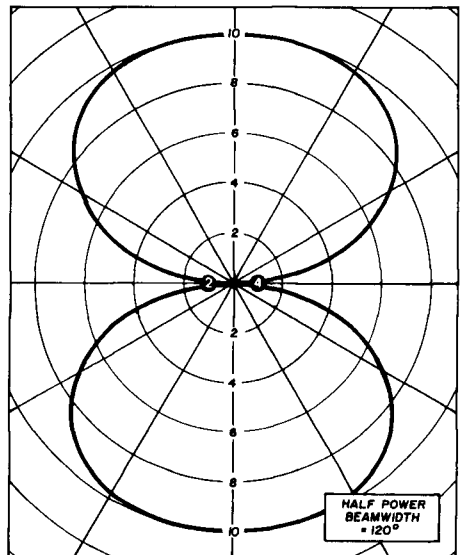
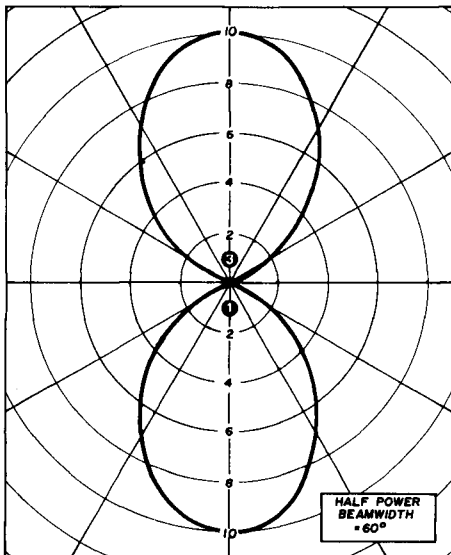

**fig. 4.** The four element positions used in the beam.

lower lobes will cancel. Thus the pattern of **fig. 6** is obtained.

The beamwidth at the half-power points, while not as narrow as a three-element Yagi or quad working under optimum conditions, is nevertheless a re-

**fig. 5.** Horizontal patterns produced by elements 1 and 3 (A) and 2 and 4 (B).



**fig. 6.** Computer-derived oscilloscope display of the horizontal polar patterns of the beam. The display of the less-dense dots was achieved by interchanging the feed lines to elements 1 and 3.

spectable improvement over that of a single vertical element.

### practical considerations

Like many antenna systems, this one is frequency sensitive, and dimensions should be chosen for the part of the band of greatest interest. As the operating frequency moves away from the design frequency, the small side lobes will decrease but the main lobe will broaden very rapidly—for frequency deviations of four percent or more.

A further point to remember is that in the theory used to design the beam the assumption is that each vertical element will not only have an identical horizontal radiation pattern (circular in this case) but will also have an identical radiation pattern in the vertical plane. Thus the four elements should be **identical in size** and placed over *similar* ground systems. For low-angle radiation the ground systems should be as extensive as possible. At the base of each element a rod should be driven into the ground at least six feet with all the radials electrically connected to the ground rod. The radials, which can be any length (the longer the better) ideally should be equally spaced about the base of the vertical with a good electrical connection to the ground rod. The elements don't have to be exactly one-quarter wavelength high, but whatever their height, they must be the same length.

### impedance matching

The elements will have a reactive as well as a resistive component. If the element length is shorter than a quarter wavelength the reactance will be capacitive; if longer, inductive.

A simple network for matching low-impedance transmission lines to a wide range of impedance is the L network. The two basic circuits are shown in **fig. 7**. Both

use one capacitor and one inductor of nearly equal reactance. The equations are for matching resistive loads only but provide a starting point for matching  $R \pm jX$  loads:

$$X_1 = \pm \sqrt{Z_0(R - Z_0)}$$

$$X_2 = \pm R \sqrt{\frac{Z_0}{R - Z_0}}$$

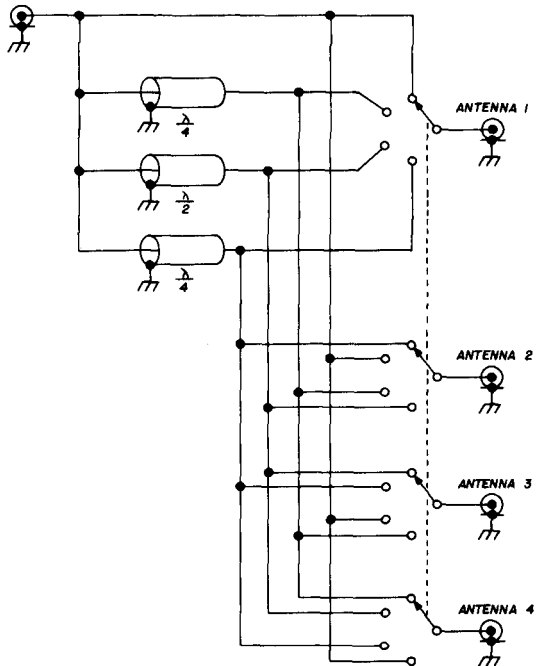

**fig. 8.** The wiring diagram for the phasing switch.

**fig. 7.** The L networks, which can be used for matching the coaxial cable to each element.

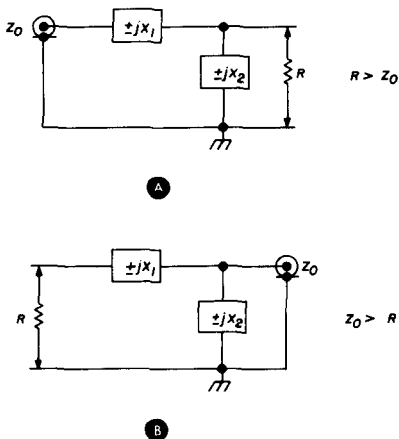

Either  $X_1$  or  $X_2$  can be the inductive reactance, so a maximum of four variations is possible. By connecting a reflected-power indicator in the coax line to each element, each circuit variation can be tried until no reflected power is indicated. The antenna impedance will then be matched, and a weatherproof container can be constructed and placed at the base of each element to house the matching networks.

The impedance match of each element should be checked, because there will be some element interaction. When each element is matched to a coaxial cable all elements should be connected through

equal lengths of cable (the specific length is immaterial) to a control box placed at the center of the system. This box should contain a rugged 4-pole, 4-position switch; preferably remotely controlled. The switch wiring diagram is shown in fig. 8.

After passing through the switch and the phasing cables (working backwards from the antenna), the four lines are joined in parallel. This has the effect of presenting an impedance of 12.5 ohms (for 50-ohm cable) to be fed from the single line from the transmitter. An impedance-matching transformer is needed at this point, and the L-network could be used again; however a better system is shown in fig. 9. This is equivalent to two pi-networks back-to-back. It can be installed in the control box and adjusted for a flat line to the transmitter.

Since devising this scheme I've moved from England to Ohio, and at present I have no means for testing the idea. But the principles are sound and the method should provide an incentive for those who

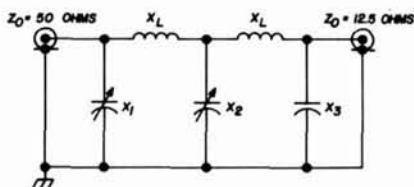

fig. 9. The 50/125-ohm impedance matching transformer. Typical values would be  $X_1 = 20$  ohms,  $X_2 = 65$  ohms,  $X_3 = 10$  ohms; inductive reactance is 2 times  $X_2$  or 130 ohms. Either  $X_1$  or  $X_3$  can be fixed.

like to work DX but don't have space or funds to put up a low-frequency rotary beam. The current sunspot maximum has passed, and DX activity will decline on the higher frequencies. I believe this antenna will give you a good chance to compete in the next DX contest.

#### references

1. W. D. Stead, VE3DZL, "Twins on Twenty," *QST*, May, 1961, p. 24.
2. J. A. Turner, W9LI, "A Compact Beam for 40 and 20 Meters," *QST*, January, 1954, p. 17.
3. A. D. Mayo, W5DF, "7-Mc Beam for the Small Yard," *QST*, September, 1952, p. 25.

ham radio



## IT'S HERE - THE GALAXY FM-210!

AT LAST, ALL AMATEURS HAVE AVAILABLE A TOP QUALITY, AMERICAN MADE 2 METER FM TRANSCEIVER AT A PRICE ALL CAN AFFORD. THIS FULLY SOLID STATE, FET FRONT END TRANSCEIVER OFFERS NO COMPROMISE PERFORMANCE FOR DIRECT OR REPEATER COMMUNICATIONS. A FULL 5 WATTS OF POWER OR 10 WATTS WITH THE OPTIONAL AC-DC POWER BOOSTER. HOW DOES GALAXY DO ALL THIS FOR

**\$199.95**

PLACE ORDERS NOW FOR EARLY DELIVERY  
SMALL DEPOSIT

### FALL CLEARANCE SPECIALS

(Definition of CLEARANCE,  
Removal of Obstructions or Hindrances)

<b>DRAKE:</b>	
R4-A .....	\$315.00
TR-4, RV-4, AC-3 (Pkge.) .....	\$575.00
<b>GALAXY:</b>	
Gal. V Mk2, AC-400 (NEW) Remote VFO (Pkge.) .....	\$395.00
Gal. V Mk2 (No Pwr.) .....	\$295.00
<b>HALLICRAFTERS:</b>	
HT-37 (Like New) .....	\$210.00

Write for list of other Gear:  
What Are Your Needs?

WANTED TO BUY FOR CASH, COLLINS EQUIPMENT, "S LINE" KWM-2 or What Have You?

*Bob's* **AMATEUR**  
**ELECTRONICS**

"THE COMPLETE HAM STORE"

Phone CE 5-6387

927 N.W. 1st Oklahoma City, Oklahoma 73106

"WE TAKE TRADE-INS ON ALL LINES OF NEW EQUIPMENT"  
TWO-WAY RADIOS - SALES - SERVICE - INSTALLATIONS



# counters:

**a solution  
to the  
readout problem**

Counter decoding  
is simple  
and certain  
with this  
decade module

Henry S. Knoll, Jr., WAØGOZ, 3392 Ebba Street, White Bear, Minnesota 55110 ■

Three excellent articles have recently been published that give the beginner a good basic understanding of integrated circuits and of IC electronic counters.<sup>1,2,3</sup> Each of these counters has one basic complexity however; namely, the readout of the count. The counter in reference 1 reads out in binary, which is satisfactory up to about 10, but nerve-wracking when having to sum 1024, 156, 16, 8 and 1 for example, to count 1305. References 2 and 3 show readout in decades by 10's. This is easiest to read but requires decoding matrices, which are expensive to build and require panel space for

table 1. BCD counting logic

Count	A	B	C	D
0	0	0	0	0
1	1	0	0	0
2	0	1	0	0
3	1	1	0	0
4	0	0	1	0
5	1	0	1	0
6	0	1	1	0
7	1	1	1	0
8	0	0	0	1
9	1	0	0	1
10	0	0	0	0

ten light bulbs per decade.

A simpler solution is a readout in what is called 1, 2, 4, 8 binary-coded decimal (BCD). With this scheme, which is not new, readout is in decades, but counting within the decade is by binary. Since the highest number count per decade is 9, the binary is easy to decode mentally. This system requires fewer components and less space than straight decimal, because only four light bulbs per decade are required.

the flip-flops are the preset terminals for each unit. These terminals are tied together. When a positive voltage is applied, all of the NOT true outputs go to a high state, and all light bulbs illuminate. The first pulse into the decade will turn all the lights off. This results in a counting error of one, which isn't important at high counts. This can be eliminated if the gating logic of reference 1 is used, which gives an extra pulse. This pulse can be used to clear the preset condition.

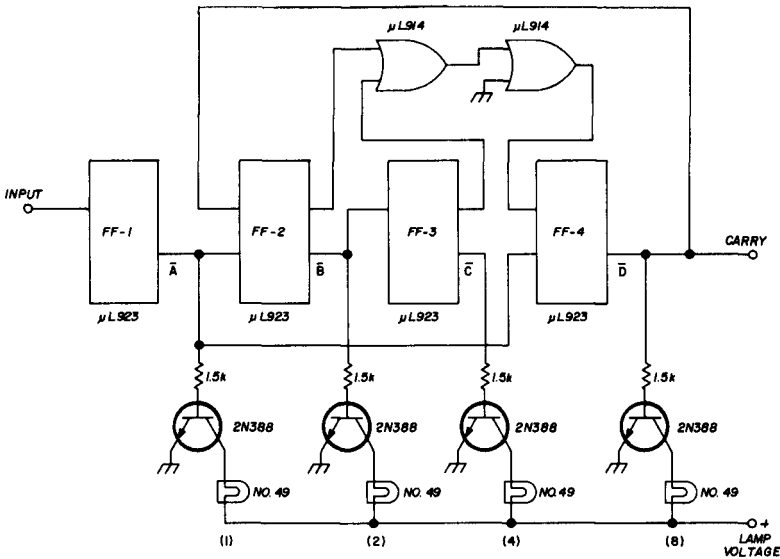

fig. 1. Schematic of the 1, 2, 4, 8 BCD counting decade and lamp drivers.

The counting logic for 1, 2, 4, 8 BCD is shown in **table 1**. A one indicates that the light is on; a zero indicates the light is off. Each decade counts in binary up to 9. The tenth input pulse sets the decade to zero again and passes a carry pulse to the next decade.

The circuit of **fig. 1** shows the simplicity of the counter, and a printed circuit (**fig. 2**) makes the wiring even simpler.

### operation

Referring to **fig. 1**, terminals marked p on

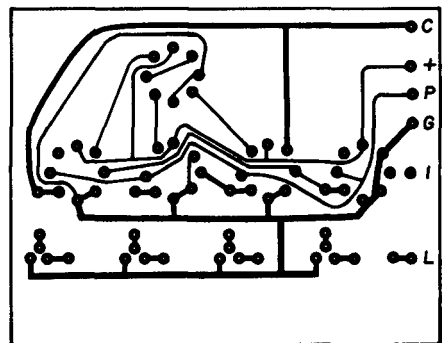
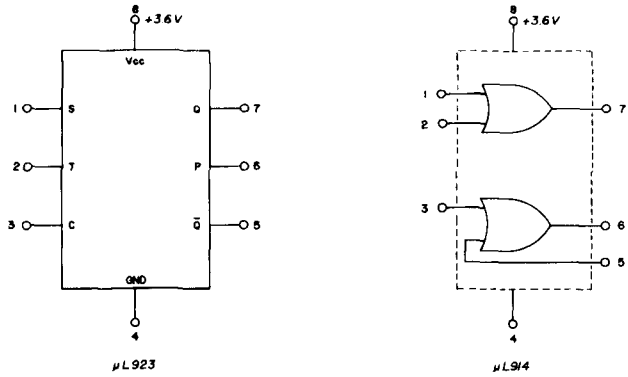

fig. 2. Printed circuit board layout.

fig. 3. Base diagrams for the  $\mu\text{L923}$  and  $\mu\text{L914}$ , top view.



Numbers in parentheses next to the light bulbs in fig. 1 indicate the value of that bulb in counting. For example, if the first and last bulbs are on, the count is nine.

**construction notes**

All flip-flops are Fairchild  $\mu\text{L923}$ , all transistors are 2N388, all light bulbs are number

wave input without preconditioning. A  $\mu\text{L914}$ , wired as shown in fig. 4, will drive them. Wiring is shown for either switch closure or electrical input.

To make a BCD counter, use all the reference 1 or 2 circuitry except for the counting decades, and add in their place the ones shown here.

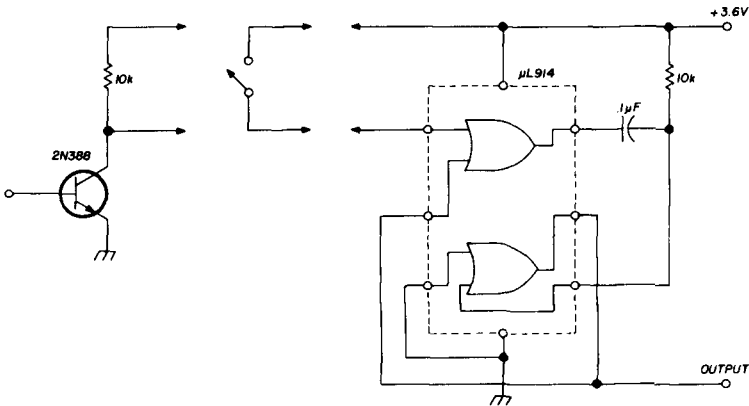

fig. 4. A method of signal preconditioning using  $\mu\text{L914}$ 's.

49, and all resistors are 1.5 kilohms, 1/4 watt. For those who have never used IC's before, base diagrams are always shown as a top view. The diagrams and operating voltages are shown in fig. 3.

Don't expect these flip-flops to work reliably from a battery and switch-closure arrangement. They won't even count with sine-

**references**

1. R. Suding, W8NSO/WØLMD, "Cheap and Easy Frequency Counter," 73 Magazine, November 1967, p. 6.
2. G. Jones, W1PLJ, "An IC Electronic Counter," 73, February 1968, p. 6.
3. D. Lancaster, "Low Cost Counting Unit," Popular Electronics, February 1968, p. 27.

**ham radio**

# COMPARE IT?

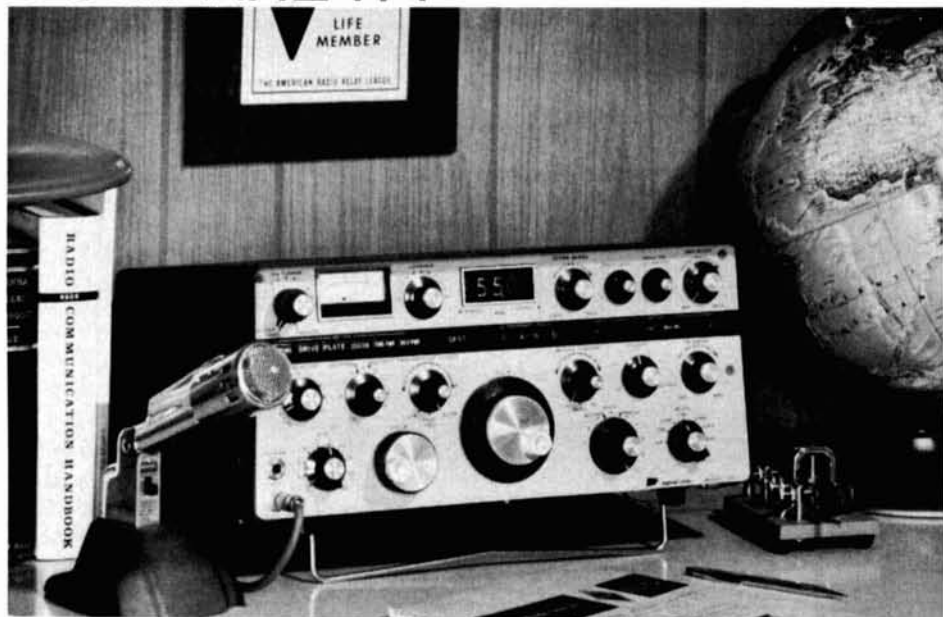

## ...WITH WHAT?

The CX7 practically demands comparison. Question is . . . what to use for a standard? A transceiver? Or transmitter-receiver separates?

You'll really need one of each. Don't forget power supplies, speech processor, keyer, directional wattmeter. Pick the best. In fact, set up your "dream station" . . . at least on paper. NOW . . .

WHATEVER YOUR CHOICE IN THE PAST . . .

**COMPARE IT POINT-BY-POINT** with the NO-COMPROMISE CX7 . . .

COMPARE the CX7 with any receiver for sensitivity, selectivity options, dynamic range, AGC merit, VFO smoothness, interference rejection . . .

COMPARE the CX7 with any transmitter for continuous power output in all modes, P.A. ruggedness, crisp audio punch, low distortion, instant CW break-in and spotting, quick band-change . . .

COMPARE the CX7 with any transceiver for total size and weight . . . the extreme flexibility of its dual-channel system . . . the convenience of its completely self-contained design . . .

CONSIDER the CX7's incomparable frequency coverage and readout precision . . . aerospace-bred excellence in engineering and craftsmanship . . . built-in "extras" . . . overall versatility . . .

SEE WHAT YOU'VE BEEN MISSING?

*"It Speaks for Itself"*  
**signal/one**

A Division of ECI (An NCR Subsidiary)

Write for detailed technical information.

2200 Anvil Street N. • St. Petersburg, Florida 33710

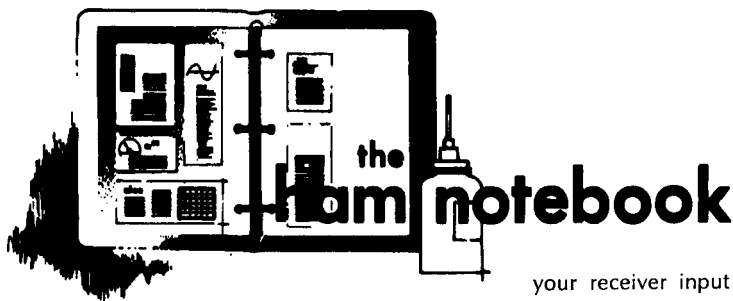

## antenna impedance transformer for receivers

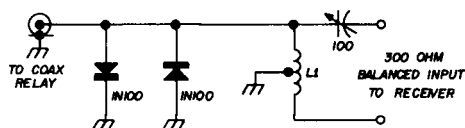

fig. 1. Receiver antenna coupler. L1 is 10 turns no. 12 enameled, tapped at the center.

Amateurs spend a great deal of time and effort to obtain an impedance match between transmitter and antenna. The reason is obvious, of course. They want maximum power transfer with minimum loss; besides, it's just plain good engineering practice.

While visiting several local stations, I was impressed with the fact that many hams neglect the other end of the circuit: matching their antenna to the input impedance of their receiver. Receiver manufacturers have no way of knowing what type of antenna will be used, so a compromise is made in the receiver input circuit. The receiver is usually designed for a balanced 300-ohm load.

If you run a length of 50-ohm coax from your antenna relay to this type of input circuit, an impedance mismatch of 6:1 will result. A little figuring will show that the input signal, with this mismatch, will result in a substantial loss.

The little gadget shown in fig. 1, mounted on a small phenolic board and attached to

your receiver input terminals, will increase your receiver sensitivity by as much as 6 dB (voltage ratio of 2).

If the coil and capacitor combination has a Q around 10 or so, you can adjust the trimmer for maximum response and the circuit will work without retuning on each band. If the Q is higher, of course, you'll have to readjust the trimmer for greater frequency excursions.

A note of caution: Most coax antenna relays have quite high isolation (up to 40 dB) between transmitting and receiving positions. However, with this transformer in the circuit of a receiver having an fet front end, the additional increase in input signal could damage the fet; relay isolation notwithstanding. A couple of diodes, placed as shown in fig. 1 will protect the fet from overload.

Alf Wilson, W6NIF

## mounting bnc connectors

Whenever I mount a BNC connector on a panel, I end up scratching the panel as I tighten down the connector's retaining nut. The answer to this problem lies in a simple homemade tool. I cut the tip off an old screwdriver and epoxied a BNC female fitting to the shaft with metal epoxy. Now, when I install a BNC panel connector, I use the modified screwdriver to hold the connector while I tighten the nut—no more frayed tempers or scratched panels.

Elliott Kanter, W9KXJ



## galaxy feedback

When using the Galaxy V MK2 transceiver it's not unusual to have trouble with rf feedback. This is particularly annoying on 10 and 15 meters.

In most cases the problem can be traced to a gassy 12BZ6 rf stage. In this transceiver the tube is operating fairly close to the maximum design limits, and as a result it has a tendency to become prematurely gassy. The useful life of the 12BZ6 can be increased by reducing the plate voltage by 40 volts; according to Galaxy Electronics, this does not alter the published specifications of the receiver.

Plate voltage on the 12BZ6 is reduced by simply replacing resistor R90 (220 ohm, 1 watt) with a 5600 ohm, 1 watt unit. Resistor R90 is located on the Vector extension of the 6GK7 driver and is very easy to change.

Jim Willis, WA5TFK

## improving alc response in the SB-400 and SB-401

When using the Heath SB-400 or SB-401, there's no rf output for several seconds when switching out of the spot mode. The slow release time of the alc circuit prevents the ssb signal from reaching succeeding stages for several seconds. This seems like an eternity during contest operation.

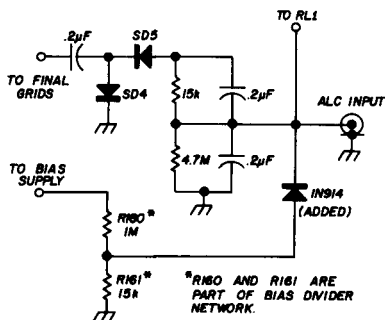

fig. 2. Adding a diode to improve alc response in the SB-400/401. The added diode should have near-infinity back resistance.

This problem is caused by a voltage spike passed to the alc network when switching out of the spot mode. The final amplifier bias changes suddenly from -100 V to -50 V, which creates a 50-volt pulse. This pulse must bleed off the alc line before the transmitter can operate.

I solved this problem by installing a silicon diode as shown in fig. 2. However, a word of caution is in order. Adding the diode places it in series with a 4.7 megohm resistor in the voltage divider on the output side of the alc network. If the back resistance of the added diode is too low, a permanent voltage will be put on the alc line. This will decrease transmitter gain.

For example, assuming a back resistance of 47 megohms in the diode, the 3 V bias on this diode will produce 0.3 V on the alc line. Of course, a lower diode back resistance will put a higher permanent voltage on the alc line. So make sure the diode measures near infinity in the backward direction!

With a good diode, alc voltage will be 3 V. This doesn't interfere with alc operation in my particular rig, but I can't guarantee it won't create a problem in other transmitters.

David Wojcinski, WA9FDQ

## modular fm receiver

There has been some misunderstanding regarding the Plectron circuit boards described in the fm communications receiver article in the June, 1969 issue. The Plectron part numbers given in the article were not correct, so inquiries made to the company received negative replies. To readers who had their requests for printed-circuit boards turned down, we offer our apologies for the confusion.

If you are interested in purchasing Plectron boards for the fm communications receiver, send your order to Mike Meyer, Plectron Corporation, Overton, Nebraska 68863. High-band rf board number 3872, \$12.95; low-band rf board number 3883, \$9.00.

## transistor replaces relay

About five years ago I built a TO-type keyer based on Jim Ricks' circuit. The relay that I used originally was not the recommended (and expensive) type and it lasted about three months. I replaced it with another one that was hermetically sealed; a surplus unit that originally cost someone about \$55. It lasted about nine months.

So I tried a cheapie—an open-frame relay that I picked up at a surplus store for 29c. Surprisingly, it lasted four years and was still going when I decided to replace it with a transistor.

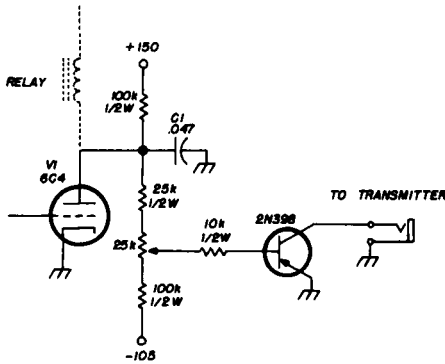

fig. 3. Solid-state keyer for the W9TO keyer. C1 eliminates any transients generated by the multivibrator.

The idea was to do a minimum of reworking on the TO circuitry. Fig. 3 shows the changes. V1 is the relay driver tube; the relay coil is disconnected from the plate, and the plate is tied to the resistor network shown in the diagram. The 25k potentiometer can be a miniature unit put in some inconspicuous but accessible place; once it's set, it can be forgotten.

The output to the transmitter is the transistor collector. This type of keying can only be applied to a system using grid-block keying where the keyer shorts a negative voltage to ground through a relatively high resistance.

After completing the modification, turn the potentiometer fully counter-clockwise before turning on the power. Recheck your wir-

ing to be sure. Turn on the transmitter and the keyer. When warmed up, the transmitter will come on as though you were holding down the key. Press and hold the dot paddle, and while doing so, slowly turn the pot clockwise until you see that the transmitter is being keyed by the dots. To acquire a feel for the marginal area, turn the pot back and forth and notice the transmitter reaction. Turn the potentiometer clockwise a little past the marginal area—that's it.

The purpose of C1 is to eliminate any transients generated by the primary free-running flip-flop. The transient occurs during the dash period when the free-running multivibrator goes negative. When the relay was used, the transients were not apparent because of the relay's inertia and the short time of the transient. But with a fast transis-

fig. 4. Wavetrain when the dash paddle is keyed. The multivibrator transients weren't a problem with the original keying relay because of the inertia of the armature.

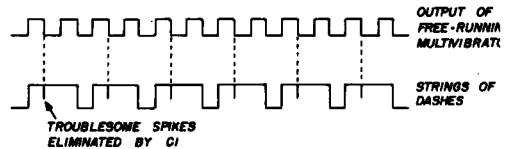

tor, the transient could (and did) appear on the carrier. C1 was selected to provide adequate filtering without materially affecting the dot-space ratio. It did have a slight effect which was compensated by readjusting the keyer weight control.

It's a great improvement. No more relay chatter (which the wife appreciates). No more contact bounce, no relay replacements to make, and it's really fast!

A note on the 2N398: The technical data shows that it can hold off 105 volts. The voltage that it's holding off in my Heath Apache is 105 volts. This is really riding it close. However, it's been on the air every night for several months and is still going strong.

Frank Case, W3NK

## NEW SINGLE-BAND BEAM FROM MOSLEY

# The Classic 20 WITH EXPANDED DX CAPABILITIES

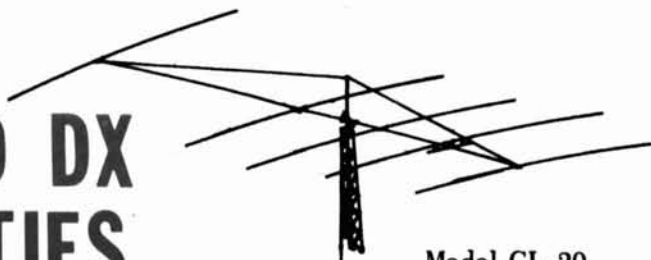

Model CL-20

### ON 20 METERS

#### DON'T LIMIT YOURSELF!

When you install a 20 meter beam, there is only one antenna investment you can afford . . . The NEW CLASSIC 20 with expanded DX capabilities, thanks to the new Classic Feed System "Balanced Capacitive Matching". This new array promises to be the most universally accepted amateur beam ever developed for 20 meters.

#### TAKE A LOOK AT THE VITAL STATISTICS!

- POWER RATED: 1 KW AM/CW; 2 KW P.E.P. SSB input to the final.
- SWR: 1.5/1 or better.
- MATCHING SYSTEM: Balanced Capacitive.
- FEED POINT IMPEDANCE: 52 ohms.
- NUMBER OF ELEMENTS: 5. Aluminum tubing; 6063-T832.
- MAXIMUM ELEMENT LENGTH: 38 ft. 1½ in.
- BOOM LENGTH: 46 ft.
- RECOMMENDED MAST SIZE: 3 in. OD.
- TURNING RADIUS: 28 ft.
- WIND SURFACE: 18.7 sq. ft.
- WIND LOAD (EIA Std. 80 MPH): 364.45 lbs.
- ASSEMBLED WEIGHT: Approx. 139 lbs.
- SHIPPING WEIGHT: Approx. 145 lbs. via truck.



Pat. No. 3419872

Mosley is the name. Antennas are our business. Designed, engineered and manufactured by hams . . . for hams. For detailed brochure on the entire CLASSIC LINE of single and multi-band beams, write . . . Dept. 198

# new products

## hybrid ic amplifier

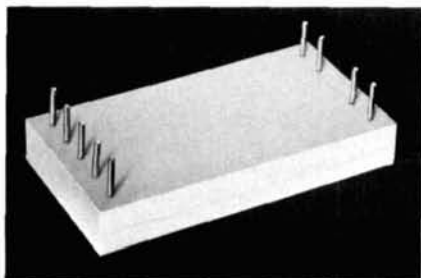

Bendix Semiconductor is currently offering the first hybrid integrated-circuit device capable of a sustained 15 watts output. The 15-watt class-B audio amplifier exhibits distortion of 1 percent or less while operating into conventional loudspeaker loads. An input signal of 350 mV will drive it to full output; this is compatible with most existing audio preamplifiers. Trimming of idle current and crossover characteristics is provided through external terminals. The BHA-0002 is designed for use in high quality receivers, stereo/hi-fi amplifiers, public address systems, intercoms and music systems. Power gain is 60 dB, frequency response is from 25 Hz to 20 kHz, input impedance is 18 kilohms, efficiency is 60 percent, and noise output relative to 15 watts is minus 70 dB. \$9.40 from your local distributor, or write to Bendix Semiconductor Division, South Street, Holmdel, New Jersey 07733.

## breadboard kit

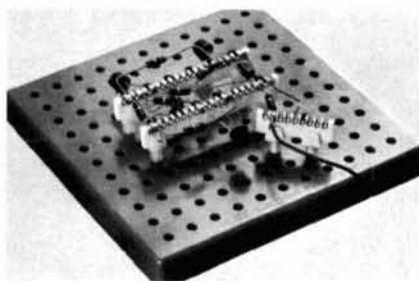

Alco Electronics has recently come out with a design board with pre-punched holes for plug-in Alco terminal strips for breadboarding circuits. The Alcostrips may be quickly inserted and removed from the design board when experimenting with new circuits. The complete circuit-board kit includes 16 Alcostrips in eight different sizes and one design board. \$10.95 from your distributor, or write to Robert Laffey, Alco Electronic Products, Inc., Lawrence, Massachusetts 01843.

## tuning diodes

Sophisticated frequency control of uhf circuits is possible with a new series of high-Q tuning diodes from Motorola. The 1N5461-1N5476 series operate over a 30-volt range and are available with a nominal capacitance tolerance of 2 percent (C suffix). This high uniformity is essential where stage-to-stage tracking in tuning is required, but for less stringent requirements 5 percent and 10 percent units (B and A suffixes, respectively) are available.

The nominal capacitance range of these diodes runs from 6.8 to 100 pF. The minimum Q is 600 for the 1N5461A (6.8 pF), and 200 for the 1N5476A (100 pF). The minimum tuning ratio (capacitance at 2 V to capacitance at 30 V) is 2.7. For data sheets with typical design curves, write to Technical Information Center, Motorola Semiconductor Products, Inc., P. O. Box 20924, Phoenix, Arizona 85036.

## telequipment solid-state oscilloscope

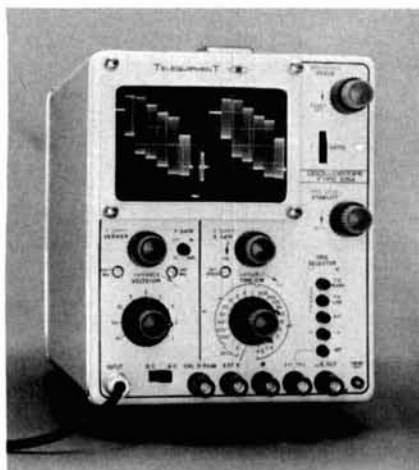

The first thing you notice when you unpack the new Telequipment S54 solid-state oscilloscope is its remarkably compact size. It's only 7-inches wide, 9-inches high and 16½-inches deep including rear CRT protection and panel knobs. Plus it's lightweight—a very attractive package. While the price is more than most of us have been accustomed to paying, it is in line when you consider the excellent specifications and performance. The S54 is built by Telequipment, an English subsidiary of Tektronix. Therefore it's backed by the Tektronix reputation for quality and their excellent field service organization.

The almost 100% transistorized circuit promises long life; power consumption is so low (30 watts) that the cabinet does not get warm even if the instrument is left on all day.

The S54 features triggered sweep, 35 ns rise (per AF book) time, 3 dB bandwidth from dc to 10 MHz and calibrated vertical and horizontal deflection amplifiers. The one item that sets this professional instrument apart from the usual scope is the use of triggered rather than recurrent sweeps. The scope trace is triggered line by line on a selected point of an incoming test signal—depending on the operating mode. This is selected by front-panel pushbuttons which give you a choice of tv frame, tv line or

other triggering modes. The two tv modes are convenient for tv service work since the scope easily locks on to the horizontal sync and displays the color burst with no attenuation. In this respect, stability is far superior to lower priced scopes.

The S54 uses an unregulated power supply but the stability is entirely satisfactory. The only tubes besides the CRT are the nuvistors in the vertical input circuit. Vacuum tubes are much more tolerant of inadvertent overvoltages than transistors and can occur if the scope is connected to a strong input signal before the input attenuator is adjusted.

The sweep speed is selected by a calibrated range switch; 22 speeds are available, from as slow as 2 seconds per cm up to 0.2 microseconds per cm. The low speeds might be used by amateurs experimenting with slo-scan tv or ESSA weather pictures. The faster speeds are of interest if you're working with rf or digital circuits.

The price on this versatile new scope is \$350. For more information, contact your local Tektronix office or write to Tektronix, Inc., P. O. Box 500, Beaverton, Oregon 97005.

## audio-frequency standard

The Pioneer model 300R is a highly stable solid-state audio-frequency standard that uses a newly developed quartz resonator in a temperature-controlled oven. Up to three standard frequencies may be selected from the front panel, with stability to 0.005%. This instrument is especially useful for setting up rty equipment, but may be used for calibrating oscillators, oscilloscopes and bridges. It is also useful for making highly accurate inductance and capacitance measurements. The model 300R functions as either a tone receiver or tone transmitter; the model 300K is a kit version of the model 300 without a cabinet. For more information, write to G. G. Glassmeyer, K6REU, Pioneer Electronics, 738 Pacific Street, San Luis Obispo, California 93401.

# CQ de W2KUW

## WE NEED YOUR SURPLUS TUBES

1P21	3CX2500
2C39	3CX3000
2K25	3CX5000
2K48	3CX10,000
2K (any digits)	3E29
3-400	3K (any digits)
3-1000	4-65
3B24	4-125/4D21
3B28	
4-250/5D22	4CX3000A/8169
4-400A/8438	4CX5000A/8170
4-1000A/8166	4CX5000R/8170W
4X150A	4CX10,000/8171
4CX250B	4X150G/8172
4CX250R/7580W	4PR60A or B
4CX300	4PR (any digits)
4CX250A/8321	5-125B/4E27A
4CX1000A/8168	
5R4WGB	304TL
6BL6	VA (all types)
6BM6 or 6A	250TH
6L6	450TH
7D21	450TL
8D21	QK (all types)
9C21	715C
9C25	802
75TL	
805	891R
807	TW (all types)
810	TWT (all types)
811A	NL (all types)
812A	4000 series
813	5000 series
832A	6000 series
833A	7000 series
891	8000 series

Please send us your surplus inventory lists. We want to buy other tubes and TX — RX — test equipment.

## The TED DAMES Co.

308 HICKORY ST., ARLINGTON, N. J. 07032  
Phone: 201 998-4246

## high-frequency oscilloscope



The new economy-priced Leader LBO-52B oscilloscope features a 3 dB bandwidth from dc to 10 MHz with hybrid circuitry. Its 10 mV/cm sensitivity makes it especially suitable for low-level rf signals in ssb equipment and i-f amplifiers. The wide sweep range has automatic synchronization, and the vertical and horizontal inputs are direct coupled to push-pull amplifiers for distortion-free displays. The units also provide vector pattern display for color tv circuits—this permits viewing patterns at the chroma detector to align the chroma section of the tv set. Priced at \$199.00 from Leader Instrument Corporation, 24-20 Jackson Avenue, Long Island City, New York 11101.

## antique tubes

If you're working with old radio gear, but can't find a particular vacuum tube, you might try Arcturus Electronics. They recently acquired nearly 10,000 obsolete tubes, circa 1925-1930, to add to their already considerable inventory of the same hard-to-get types. Listings plus prices of thousands of other items are included in their recently published catalogue, which they will send on request. Write directly to Arcturus Electronics Corporation, 502-22nd Street, Union City, New Jersey 07087.

## solid-state voltmeter



One of the best items to come from Heathkit in quite awhile is the new IM-17 utility solid-state voltmeter. The IM-17 uses one fet and four bipolar transistors plus one diode to provide vtm performance.

All of the electronic components are on one circuit board; this and the front panel slides into a plastic case which folds over to cover up the whole unit. A handle is molded into the case for carrying.

The ranges of the IM-17 are from zero to 1000 volts ac or dc and zero to 100 megohms. With the fet input circuit this vtm acts like a vtm with a high input resistance so any circuit under test will not be loaded down. The input resistance on the dc ranges is 11 megohms. The dc scale is covered in four positions, as is the ac scale. The resistance ranges are 1, 100, 10k and 1 megohm center scale. There are no current ranges. The only thing not included in the kit are two batteries; one C cell and an 8.4-volt mercury cell. The mercury cell wasn't available at the local radio store but the manual came to the rescue with a recommended substitute.

The IM-17 makes a nice meter for primary use in the shack or as a second one to use on the mobile or field day. If you've been looking for a new meter, here is a vtm that acts like a vtm for only \$21.95.

ham radio

# BOOKS!

Radio Society of Great Britain

## RADIO COMMUNICATION HANDBOOK — Fourth Edition

A complete guide to virtually all technical aspects of amateur radio. Over 50% larger than previous editions. Prepared by the outstanding amateurs in Great Britain today. 832 pages. Hardbound \$11.95

## AMATEUR RADIO TECHNIQUES — Second Edition

J. Pat Hawker, G3VA  
Brand new edition — completely revised. A very complete collection of short articles and ideas covering many aspects of amateur radio. Includes new enlarged semiconductor section. 160 pages. Only \$2.50

## AMATEUR RADIO CIRCUITS BOOK

Completely revised — new edition. A very handy collection of many useful circuits for amateur use. Loaded with good ideas for that new converter, exciter or other project you are working on. Only \$2.00

## RADIO DATA REFERENCE BOOK — Second Edition — By G. K. Jessop, G6JP

Here in a 148 page book is one of the most complete compilations of radio and electronic charts, nomographs, formulas and design data available. Whether you design, build or operate, this is a book you must have. Only \$2.50

## WORLD AT THEIR FINGERTIPS — John Clarricoats, G6CL

A very interesting history of the RSGB and of amateur radio in Great Britain. It gives a great insight into the development of our hobby. Paper back edition \$2.50  
Deluxe edition \$6.50

## Other Important Volumes

### RADIO HANDBOOK — 18th Edition

How to design, build and operate the latest types of amateur transmitters, receivers, transceivers and amplifiers. Provides extensive, simplified theory on practically every phase of radio.

Over 800 pages Only \$13.50

**ALL ABOUT CUBICAL QUAD ANTENNAS** by W6SAI  
Construction and tuning data. Multi-band Quads. Charts, drawings and photos for your Quad. Full complete data on homemade Quad antennas. The new X-Q Quad. \$3.95

**VHF HANDBOOK** by Orr W6SAI & Johnson W6QKI  
First complete Handbook covering the VHF spectrum! Many VHF construction projects. Design and construction of VHF transmitters, receivers and antennas! Make your VHF station work! \$3.75

### THE CARE AND FEEDING OF POWER GRID TUBES

by Robert Sutherland, W6UOV  
Just as the title says, a very complete rundown on the use of power tubes. Be sure to read this before you start work on your new linear.

Only \$3.95

### BEAM ANTENNA HANDBOOK

by William Orr, W6SAI  
New edition. Theory, design, construction, and the installation of rotary beam antennas! SWR data! Multi-band beams, 40 meter beams, 20 meter DX beams! How to make your beam work! 200 pages. \$3.95

### NOVICE & TECHNICIAN HANDBOOK

by W6SAI and W6TNS  
All about amateur radio in non-technical language! How to learn the code. How to assemble your ham station. Transmitters! Receivers! DX! How to get QSL cards. \$2.95

### ELECTRONIC CONSTRUCTION HANDBOOK

by Robert Lewis, W8MQU  
All about design - construction - layout and testing of electronic equipment. Non-technical guide for kit-builders and your best key to better performance of your equipment! \$2.95

Postpaid in USA & Canada

comtec

Box 592 • Amherst, New Hampshire 03031

# **saroc**

5th Annual National Convention

**QTH... STARDUST HOTEL**, Las Vegas, NV.

**QTR... February 4-8, 1970**



Cocktail Parties by

**HAM RADIO Magazine, SWAN, GALAXY.**

Ladies Luncheon Program.

**SECOND NATIONAL FM MEETING**

Technical seminars; meetings by

**ARRL, MARS, QCWA, WCARS-7255, WSSBA.**

Send stamped, self-addressed envelope  
for SAROC accommodations, group rate and advance  
registration blank.

**saroc** Box 73,

Boulder City, Nevada 89005

**HOSTED BY SOUTHERN NEVADA ARC, INC.**



# partners in excellence

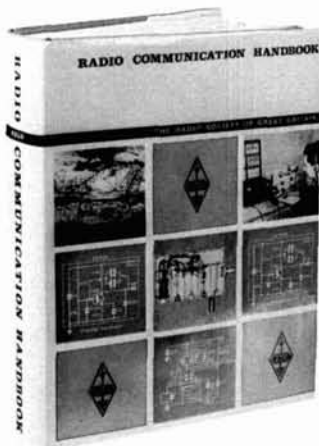

An outstanding technical guide to all phases of amateur radio. In 832 pages 20 complete chapters are devoted to such subjects as single sideband, antennas, mobile equipment, RTTY and much, much more.

This excellent book has received wide acclaim on both sides of the Atlantic and belongs in your library . . . now. **\$11.95**

#### OTHER

#### POPULAR RSGB PUBLICATIONS

Radio Date Reference Book	\$2.50
VHF-UHF Manual	3.75
Amateur Radio Techniques	2.50
Amateur Radio Circuits Book	2.00
World at Their Fingertips	2.50

All prices postpaid in USA & Canada



Many thousands of you have become very familiar with the various Radio Society of Great Britain books and handbooks, but very few of you are familiar with their excellent magazine, **Radio Communication**.

This is the oldest and most widely read British amateur radio magazine. Published monthly it provides complete coverage including such popular features as: *Technical Topics*, a monthly survey of the latest ideas and circuits, *Four Meters and Down*, a rundown of the latest in VHF and UHF and much more.

It includes numerous technical and construction articles in addition to a complete rundown on the month's events in amateur radio. Surely a most interesting addition to your amateur radio activities.

We can now offer this fine magazine to you along with the other advantages of membership in the RSGB (such as use of their outgoing QSL Bureau) for only \$6.00 a year.

book division  
**comtec**

Box 592 • Amherst, New Hampshire 03031

"WE ARE THE EXCLUSIVE NORTH AMERICAN DISTRIBUTOR FOR RSGB PUBLICATIONS —  
DEALER INQUIRIES INVITED"



# PHASE CORPORATION ELECTRONICS DIVISION

## FOUR TRACE PRE-AMP KIT

ONLY  
**\$ 24.95**

AUDIOPHILES  
HOBBYISTS  
HAMS  
TEACHERS  
ENGINEERS  
TECHNICIANS  
EXPERIMENTERS

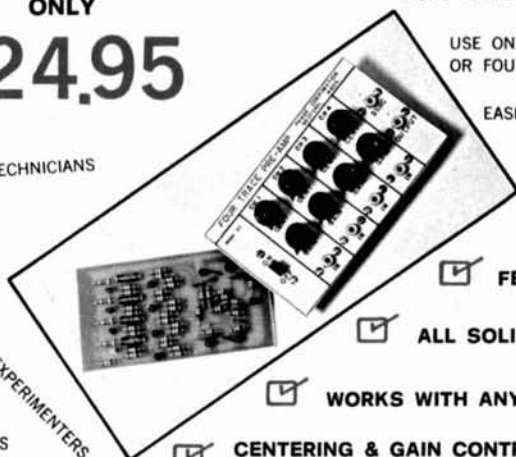

MAKES YOUR OSCILLOSCOPE  
MORE FLEXIBLE

USE ONE, TWO, THREE  
OR FOUR TRACES

EASILY ASSEMBLED

**CHECK  
THESE  
FEATURES**

- FET INPUT
- ALL SOLID STATE
- WORKS WITH ANY SCOPE
- CENTERING & GAIN CONTROLS  
FOR EACH CHANNEL

### SPECIFICATIONS:

BANDWIDTH: 1 MEGAHERTZ/CHANNEL  
 DISPLAY TIME: 50 $\mu$  SEC/CHANNEL  
 TRANSITION TIME: 5 $\mu$  SEC.  
 MAXIMUM OUTPUT VOLTS PER CHANNEL:  
 0.5 VOLTS PEAK TO PEAK  
 INPUT IMPED./CHANNEL: 1 MEG  $\Omega$   
 GAIN/CHANNEL: -20 db

KIT CONTAINS ALL PARTS, THIRTEEN TRANSISTORS (INCLUDING 4 FET'S), 2 DIODES, ALL TEMPLATES, ETCHED AND DRILLED CIRCUIT BOARD, AND COMPLETE EASY TO FOLLOW INSTRUCTIONS.

SYNC. OUTPUT PROVIDED

CAN BE BUILT INTO YOUR SCOPE, OR USED WITH THE OPTIONAL CUSTOM CABINET.

THE SENSITIVITY IS LIMITED ONLY BY THE SENSITIVITY OF YOUR OSCILLOSCOPE.

WORKS ON BATTERY VOLTAGE AS LOW AS 3V.

PORTABLE AND COMPACT

USES STANDARD 9V BATTERY (NOT SUPPLIED)

CAN BE USED AS A STAIRCASE GENERATOR WITH THREE VARIABLE LEVELS

MODEL A1K \_\_\_\_\_ \$24.95  
 CUSTOM CABINET \_\_\_\_\_ 4.98

ETCHED AND DRILLED CIRCUIT BOARD ONLY \_\_\_\_\_ \$ 5.00  
 ASSEMBLED, COMPLETE WITH CUSTOM CABINET  
 MODEL A1W \_\_\_\_\_ 49.95

THE PHASE CORPORATION, MEDFORD, MASS. 02155

Mass residents  
add 3% sales tax

Gentlemen: Please send the following

*Please print*

- Model A1K \_\_\_\_\_ \$24.95    Name \_\_\_\_\_  
 Custom Cabinet \_\_\_\_\_ 4.98    Street \_\_\_\_\_  
 Model A1W \_\_\_\_\_ 49.95    City \_\_\_\_\_ State \_\_\_\_\_ Zip \_\_\_\_\_  
 Etched and Drilled circuit board only \_\_\_\_\_ 5.00  
 I enclose a check or money order in the amount of \_\_\_\_\_  
 Please charge this to my  Master Charge # \_\_\_\_\_  BankAmericard # \_\_\_\_\_

# flea market



**DO YOU KNOW** about the RSGB? See page 79.

**SAVE.** On all makes of new and used equipment. Write or call Bob Grimes, 89 Aspen Road, Swampscott, Massachusetts, 617-598-2530 for the gear u want at the prices u want to pay.

**THE RADIO TELEPRINTERS SOCIETY** of Northern Indiana was formed on November sixth by a group of twenty amateurs with teletype facility. These amateurs are using 146.700 MHz for RTTY and mobile operation. Most of these will probably expand their VHF band facility. The following amateurs were present at this enabling meeting: W9EZZS, WA9GAA, WA9VIM, W9FSA, WA9EJR, K9MNF, W9ZGC, WA9OKC, WA9OLQ, K9EJ, W9NAR, W9EPT, K9DOF, W9OJQ, K9WFF, W9BRM, W9JCF, WA9DAP, K9DMM. For further details contact G. S. Diehl, W9EZZS, President.

■ **RATES** Commercial Ads 25¢ per word; non-commercial ads 10¢ per word payable in advance. No cash discounts or agency commissions allowed.

■ **COPY** No special layout or arrangements available. Material should be typewritten or clearly printed and must include full name and address. We reserve the right to reject unsuitable copy. **Ham Radio** can not check out each advertiser and thus cannot be held responsible for claims made. Liability for correctness of material limited to corrected ad in next available issue. Deadline is 15th of second preceding month.

■ **SEND MATERIAL TO:** Flea Market, Ham Radio, Greenville, N. H. 03048.

**PAWNEE 2MTR TRCVR.** with HB FET pre-amp, \$135. Ameco TX6Z with Dow Key Relay, \$125. CN 144 & 50 Converter, \$45. ea. PS for conv., \$20. Heath HG10 VFO modified to drive TX6Z, \$40. K21JL, 136 Church Street - 1C, Kings Park, N. Y. 11754.

**COMMERCIAL LICENSE EXAMS:** Second \$17.50; First \$25.00; Sample questions; Price list \$1 refundable. D. C. Enterprises, P. O. Box 432, Sparks, Nv. 89431.

**NORTHERN CALIFORNIA Hams:** Best deals — new and reconditioned equipment. Write or stop for free estimate. The Wireless Shop, 1305 Tennessee, Vallejo, California 94590.

**TUBES** — Lowest World price. Foreign-American. Obsolete, current. Receiving, Special Purpose, Transmitting tubes. Send for tube and parts catalog. United Radio Company, 56-HR Ferry Street, Newark, New Jersey 07105.

**SELL: SX-100 receiver — \$100.00; Triplett meter 631 — \$40.00; or make offer. Local deal preferred. Jim, WB6MQE, Zip 91754.**

**FOR SALE: HAMMARLUND HQ-140X receiver, good condx, \$99. Local deal only. WA2HGJ, 304B South Tenth Avenue, Highland Park, N. J. (201) 572-2980.**

**ROCHESTER, N. Y.** is again Hamfest, VHF meet and flea market headquarters for largest event in northeast, May 16, 1970. Write WNY Hamfest, P. O. Box 1388, Rochester, N. Y. 14603.

**HOT CARRIER DIODES.** New HP 2800, 90¢, 12/\$10 pp. H A L Devices, Box 365H, Urbana, Illinois 61801.

**FOR SALE: FACTORY SEALED:** 30L-1, 312B-4, 312B-5, 516F-2, 75S3-B; 10% off (no trades). 30L-1, \$385. Waters #334 dummy load/wattmeter, \$70. R-390-A, cabinet \$750. HW-12-A, Drake Filter, Mike, HP-13, \$125. Eldico SSB-100-F Exciter, \$250; SSB-1000-F Linear with new spare 4CX-300-A's, \$250. KWM-2, PM-2, \$775. R-4-A (factory up-dated 9/69), in factory-sealed carton, \$325. MN-2000, \$145. DC-3, \$75. R-4-B, T-4-B, AC-4, MS-4, \$695. Waters "Codax" Keyer, \$50. Waters #3002 Hybrid Coupler, \$50. Johnson #250-20 Filter, \$9. KWM-1, 516F-1, \$225. Bird wattmeter, model 693, \$100. Stancor P-6468 (5VCT/30 amps), \$9. P-6309 (6.3VCT/20 amps), \$8. P-3060 (2.5VCT/10 amps, 10 KV ins), \$4. Power supply (UTC "CG" components), 115/220 input, 2500 VDC @ 400 MA output, \$35. HA-1 Keyer and Vibrokeyer, \$70. Vibroplex Key, \$10. P&H LA-500-M "Spitfire" Linear, new, \$75. Comdel CSP-11, \$75. SB-200/new spare T-160-L's \$200. KW Match-box with meter/indicator, \$135. KWM-2 #15750, 516F-2, (very latest!), \$875. Transformer, 115/220 input; 12/24V @ 60/30 amps. These are FB for building P. S. around Leece-Neville alternator (to run 1 K W. Mobile!), 3/\$50. James W. Craig, W1FBG, 29 Sherburne Avenue, Portsmouth, New Hampshire 03801.

**INTEGRATED CIRCUITS:** New Fairchild Micrologic. epoxy TO-5 package. 900 buffer, 914 gate, 60¢ each. 923 J-K flip-flop, 90¢ each. Guaranteed Add 15¢ postage. H A L Devices, Box 365H, Urbana, Illinois 61801.

**WORLD RADIO used gear has trial-guarantee-terms!** KWM2 — \$695.00; G50 — \$159.95; SR150 — \$299.95; HW32 — \$89.95; Swan 250 — \$229.95; DuoBander 84 — \$119.95; EICO 753 — \$129.95; TR3 — \$369.95; NCX3 — \$169.95; NC200 — \$249.95; SB33 — \$199.95; SB34 — \$299.95. FREE "blue-book" list for more. Write WORLD RADIO, Box 919, Council Bluffs, Iowa 51501.

**1916 QST'S** wanted. Especially May and June. Any unreasonable price paid! Ted Dames, W2KUW, 308 Hickory Street, Arlington, N. J. 07032.

**THE FOLLOWING LISTED US GOVERNMENT EQUIPMENT** has been reported missing from the First US Army MARS Station, A3USA (W3USA), Fort George G. Meade, MD 20755: Transceiver, Collins, KWM-2A, Serial #15513, Power Supply Collins, 516F-2, Serial #23397, Linear Amplifier, Collins 30L-1, Serial #69, Crystal Packet, Collins CP-1, Collins part number 597-040-00. Request person possessing information leading to the location of this equipment, contact the First US Army MARS Director by writing to: Headquarters First US Army, ATTN: AHACE-PT, Fort George G. Meade, MD 20755 or telephone collect to: 301 677-3316 or 677-3858.

**APPLICATIONS ENGINEER.** An excellent opportunity for a ham with a new growing company. To invent and/or implement solid-state tuning techniques for AM/FM/TV receivers. Write application notes and interface with customer at both technical and sales level. Follow up VVC tuning diodes and other semiconductor products. Contact Jerome L. Harthe, KEV Electronics Corp., Wilmington Industrial Park, Wilmington, Mass. 01887. Phone 617-658-6970.

**SAROC:** new QTH Stardust Hotel, new QTR February 4-8, 1970. Cocktail parties hosted by Ham Radio Magazine, Swan and Galaxy. For additional information and Stardust Hotel special SAROC room rate card QSP SASE SAROC, Box 73, Boulder City, NV 89005.

## GEM-QUAD FIBRE — GLASS

ANTENNA FOR 10, 15, and 20 METERS.



Two Elements \$77.73  
Extra Elements \$45.00 ea.  
Shipped Freight Collect  
INCLUDES U.S. Customs Duty

- KIT COMPLETE WITH**
- SPIDER
  - ARMS
  - WIRE
  - BALUN KIT
  - BOOM WHERE NEEDED

SEE OUR FULL PAGE IN JUNE ISSUE

Buy two elements now — a third and fourth may be added later with little effort.

Enjoy optimum forward gain on DX, with a maximum back to front ratio and excellent side discrimination.

Get a maximum structural strength with low weight, using our "Tridetic" arms.



MANITOBA DESIGN INSTITUTE  
AWARD WINNER

**Structural Glass**  
LIMITED

20 Burnett Avenue, Winnipeg 16, Manitoba, Canada

## SPACE AGE KEYS

Only  
\$67.50



- Planar epitaxial integrated circuits for reliability. No tubes—No separate transistors.
- Precision feather-touch key built-in.
- Fully digital—Dot-dash ratio always perfect.
- No polarity problems—Floating contacts switch  $\pm 300\text{-V}$  @ 100-ma.
- Rugged solid construction—will not walk.
- Send QSL or postcard for free brochure.

**PALOMAR  
ENGINEERS**

BOX 455, ESCONDIDO, CAL. 92025

**INDIANA.** The Lake County Amateur Radio Club, Inc., announces its 17th Annual Banquet to be held at Teibel's Restaurant, U. S. 30 and 41 (near Schererville, Ind.) at 6:30 p.m., CST, February 14, Chicken dinner, entertainment, speeches. Come with your wife or girl friend. Tickets \$5.00 each from Herbert S. Brier, W9EGQ, 385 Johnson Street, Gary, Indiana 46402. Positively no tickets sold at the door.

**SWAN 250** with 117XC AC supply, VOX unit, 100 kc calibrator \$325. 6M. Gonset sidewinder 910B with AC supply \$250. Gonset COMM III 6 meters \$130. Gonset COMM IV 6 meters \$155. Gonset VHF VFO #3357 \$50. Heathkit HR-10B ham band rcvr. \$60. Globe King 500A (4 ft rack) 500 watt AM & CW xmtr. \$1.50. Globe DSB 100 \$35. Hallicrafters gen. coverage rcvr. SX71 \$90. Hallicrafters military R-44/ARR-S rcvr. 28-146 megs with AC supply \$75. All equipment is in mint condition and works excellent. You pay shipping. Tom Dittrich, WB2LZD, 249 Meadow Lane, Vestal, New York 13850.

**NOVICE CRYSTALS:** 40-15M \$1.33, 80M \$1.83. Free flyer. Nat Stinnette Electronics, Umatilla, Fla. 32784.

**HAMMARLUND SUPER-PRO BC-779-B** in working order. Rack mounting model less cabinet. Includes power supply. Covers 200-400 kc. 2.5 to 20 mc. Only \$75. Hallicrafters S-40B & S-20R receivers both in good condition. S-40B \$40; S-20R \$25. All prices fob my shack. WIDHZ, Box 185, Amherst, N. H. 03031. Phone 603-673-4885.

**SSTV MONITOR,** 12 Transistors, 5 Tubes, 3RP7A CRT, \$190 or Best Offer Plus Shipping, Cohen, W4UMF, 6631 Wakefield Drive, Alexandria, Virginia 22307.

**QSLs. SECOND TO NONE.** Same day service. Samples airmailed 25¢. Ray, K7HLR, Box 331, Clearfield, Utah 84015.

**YOU WON'T** have a Happy New Year unless you attend the ARRL Hudson Division Convention, October 17-18, Hilton Motor Inn, Tarrytown, N.Y. Exhibits, Lectures, Contests, Gabfests, New York Sightseeing, Fun. Start the New Year right and QSL the Hudson Amateur Radio Council, Box 58, Central Islip, N. Y. 11722 for information.

**TOROIDs.** 88 or 44 mhy., center tapped, not potted, 5/\$2.00 POSTPAID. NOTE!! 40/\$10.00 POSTPAID. Model 32KSR page printer on pedestal, complete 60 or 100 speed printer, little used . . . \$200. FRXD10 typing reperfector with TD on same base \$25. Model 19 set \$95. Model 14TD sync motor \$18. MXD three head TD \$35. Tape winder \$6. Oiled reperfector tape \$3/box/10 or \$10/case/40 rolls. FACSIMILE paper (12" x 19") 250 sheet package \$4. Double squirrel cage blower (110VAC 60 cycle) silent type \$5. RCA CV57/URR terminal unit \$85. New Clegg 66er transceiver \$150. WANTED: Ham M rotor. Stamp for list. Van, W2DLT, 302H Passaic Avenue, Stirling, N. J. 07980.

**G3WP CHELMSFORD** England wishes to QSO someone in Chelmsford, Mass. G3WP, 43 Forest Drive, Chelmsford, Essex, England.

**WORLD QSL BUREAU** — see ad page 87.

**GREENE DIPOLE CENTER INSULATOR** . . . see ad page 96, September 1969 Ham Radio.

**RG8LL COAX,** low loss Foam Amphenol, 10¢ ft. K-200 RG86U, 20¢ ft. PL259 — SO239, 40¢ each. F.O.B. Monte Southward, R. 1, Upper Sandusky, Ohio 43351.

**HALLICRAFTERS SR400** transceiver, HA20 DX adapter (outboard vfo with swr meter), P500 ac power supply, 1½ years old, mint condition, \$800. Used as second station, never mobile, must sell. Box C, Ham Radio, Greenville, N. H. 03048, or call (617)762-5863.



# NEW!

# TBL1

## FREQUENCY MARKER

**SELF-CONTAINED UNIT  
For  
MOBILE OR BASE STATION  
BATTERY OPERATED**

The TBL1 will replace the 100 KHz calibrator built into most receivers. Using your 100 KHz XTAL this unit will provide sharp accurate markers with readouts at 100, 50, 25, 10, & 5 KHz. Keep your receiver calibrated at all times. Locate sub-band MARS frequencies and band edges.

The TBL1 frequency marker is a self-contained unit using integrated circuits, powered with 3 C-type flashlight batteries, and connects to your receiver antenna input. No internal wiring is necessary. A front panel adjustment allows zero beat with WWV.

Special introductory price less  
XTAL & batteries

# \$29<sup>95</sup>

POSTPAID USA

Frequency marker identical to above, less cabinet & switch

- Keep your receiver calibrated • Locate those sub bands
- Readouts at 5, 10, 25, 50, 100 KHz. • Useful to 50 MHz.



**SPECIFICATIONS:** Glass Epoxy Board. Adjustment to zero beat with WWV. Uses 100 KHz crystal (not supplied).

3 to 4 VDC

Compact — 1.75 x 3.75 inches. Install anywhere!

# \$16<sup>50</sup>

Complete easy-to-assemble kit  
Prices postpaid Cont. US 48, less xtal and batteries

# \$19<sup>95</sup>

Wired & Tested  
Prices postpaid Cont. US 48, less xtal and batteries

**THE RADIO SHOP  
LAB 1  
48 ELM STREET  
NEW CANAAN, CONN. 06840  
Tel: 203-966-3553**

SWITCH \$1.00 CRYSTAL \$3.50  
with purchase of any of above

# NEW ELECTRONIC FAST

- \* 8-50wpm, dot memory, inst. st.
  - \* hefty sidetone, vol. & pitch control
  - \* relay or solid state (-105V, 50mA) out.
  - \* all SIGNETICS UTILOGIC IC's (6)
  - \* matches HEATH SB styling
- Cal. residents add 5% tax
- Compl. ex. key....\$56 Kit....\$49  
 PCB only, tested w/instr. ....\$25  
 add \$3 for relay output (all ppd)

**CURTIS ELECTRO DEVICES** P.O. box 4090  
 MVw., Ca. 94040



Radio Amateurs  
 Reference Library  
 of Maps and Atlas

**WORLD PREFIX MAP** - Full color, 40" x 28", shows prefixes on each country... DX zones, time zones, cities, cross referenced tables... postpaid \$1.00

**RADIO AMATEURS GREAT CIRCLE CHART OF THE WORLD** - from the center of the United States! Full color, 30" x 25", listing Great Circle bearings in degrees for six major U.S. cities; Boston, Washington, D.C., Miami, Seattle, San Francisco & Los Angeles. .... postpaid \$1.00

**RADIO AMATEURS MAP OF NORTH AMERICA!** Full color, 30" x 25" - includes Central America and the Caribbean to the equator, showing call areas, zone boundaries, prefixes and time zones, FCC frequency chart, plus informative information on each of the 50 United States and other Countries... postpaid \$1.00

**WORLD ATLAS** - Only atlas compiled for radio amateurs. Packed with world-wide information - includes 11 maps, in 4 colors with zone boundaries and country prefixes on each map. Also includes a polar projection map of the world plus a map of the Antarctica - a complete set of maps of the world. 20 pages, size 8 1/4" x 12"..... postpaid \$2.00

Complete reference library of maps - set of 4 as listed above..... postpaid \$3.00  
 See your favorite dealer or order direct.

WRITE FOR  
 FREE  
 BROCHURE!



RADIO AMATEUR **callbook** INC  
 Dept. E. 925 Sherwood Drive  
 Lake Bluff, Ill. 60044

REVIEWED IN MARCH, 1968 HAM RADIO

## oscillator/monitor mark 2

- makes an audible tone to monitor the RF of any CW transmitter from 10Mw to 1 Kw & 100Kc to 1000Mc, using only an 8" pickup antenna.
- can be self-triggered for code practice or the testing of solid state components and circuits.
- aids in tuning up & testing RF oscillator and power circuits.
- 4 transistor, 2 diode circuit, speaker, tone adjust, AA pencil, test leads, 8" ant., & magnetic base.
- cabinet is 16 gauge black & clear anodized aluminum, 3.4 x 2.3 x 1.2" US made & guaranteed for 1 year.



14.95 complete,  
 ppd usa & can.  
 send a check or m.o.  
 sold by mail only

James Research company, dep't: HR-M  
 20 willits rd., glen cove, n.y. 11542

**ORIGINAL EZ-IN DOUBLE HOLDERS** display 20 cards in plastic, 3 for \$1.00, 10 for \$3.00 prepaid. Guaranteed. Patented. Free sample to dealers. Tepabco, John K4NMT, Box 198R, Gallatin, Tennessee 37066.

**POLICE - FIRE - AIRCRAFT - MARINE** Calls on your broadcast radio with TUNAVERTER S! Tunable - Crystal! Brochure. Salch Company, Woodsboro HMC, Texas 78333.

**HELP.** I need a good used Collins 310B Exciter, National FB7 or FB7-X and a National SW-3. All letters answered via air mail. Jock White, ZL2GX, 152 Lytton Road, Gisborne, New Zealand.

**7553B, LATEST MODEL,** with 500Hz filter, \$525. 32S1, mint, \$375. 51F2 ac supply, \$100. Drake L4 linear, \$475. Comdel CSP-11, \$80. Heathkit SB-610 monitorscope, \$65. Drake W4 swr/wattmeter, \$35. Eico 717 electronic key with Brown Bros paddle, \$40. 200-ft. new RG-17A/U with type-N connectors, \$50. 80-ft. guyed Rohn Tower, you take it down, \$50. Cushcraft 3el 20M beam, \$50; 4el 15M beam, \$50; 4el 10M beam, \$35; I'll help take down. Ham-M rotator, \$60. Fisk, Box 25, Rindge, N. H. 03461. (603) 899-5483.

**DEALERS.** Do you carry R.S.G.B. publications? They are real best sellers. Interesting and well priced. For complete information write Comtec, Box 592, Amherst, N. H. 03031.

**TOROIDS 44 and 88 mhy.** Unpotted. 5 for \$1.50 ppd. W. Weinschenker, Box 353, Irwin, Pa. 15642.

**QSL'S - BROWNIE W3CJ1** - 3111-B Lehigh, Allentown, Pa. 18103. Samples 10¢. Cut catalogue 25¢.

**HALLICRAFTERS SX-110,** excellent condition. Best offer. Raymond Martin, Greenville, N. H. 03048. Phone 603-878-2758.

**HAVE YOU SEEN** the Radio Communication Handbook? Only \$11.95 from Comtec, Box 592, Amherst, N. H. 03031.

**DAYTON HAMVENTION** April 25, 1970: Sponsored by Dayton Amateur Radio Association for the 19th year. Technical sessions, exhibits and hidden transmitter hunt. An interesting ladies program for XYL. For information watch ads or write Dayton Hamvention, Dept. H, Box 44, Dayton, Ohio 45401.

**DEALERS AMATEUR-CB.** Now is the opportunity for you to make money selling new full warranty major line equipment and accessories. Send letterhead for list c/o Robert Weaver, WA5UUK, Madison Electronics, 1508 McKinney, Houston, Texas 77002. (713) 224-2668.

**WANTED:** Old copies of R9 magazine for private collection. WIDTY, Box 25, Rindge, N. H. 03461.

**MAGAZINES.** OST since March 1944. CO since 1947. Sold as individual copies. What issues do you need? Write K1PSR, Box 132, Amherst, NH 03031.

**FOR SALE.** 6-foot rack, good condition, \$15, you come and get it. Viking Valiant excellent shape, \$150. Johnson Matchbox with swr bridge, \$35. Waters dummy load, \$40. All items fob. WIDTY, Box 25, Rindge, N. H. 03461.

**YOUR AD** belongs here too. Commercial ads 25¢ per word. Non-commercial ads 10¢ per word. Commercial advertisers write for special discounts for standing ads not changed each month.

# NEW!



## FMT-1 5 Watt 6 Channel All Solid State 2 Meter FM TRANSCEIVER

12-15 Volt Operation  
142-149 MHz with 1 MHz maximum spread  
Receiver sensitivity .3 microvolt for 20 db  
quieting  
Dual Conversion  
Mechanical Filter for sharp 28 KHz bandwidth  
5 watt RF minimum power output  
6 Channels - One set crystals for operation  
146.34-146.94 supplied  
Adjustable 5 to 15 KHz deviation  
Ready to operate - Just connect to 12 volts  
and an antenna

**\$289.95** FOB DENVER

— Certified Check or Money Order please —  
Including mobile mount & dynamic microphone  
Extra transmit or receive crystals \$7.00 each  
order from

**VHF Associates, Incorporated**  
P. O. BOX 22135, DENVER, COLO. 80222

## NEED CRYSTALS?

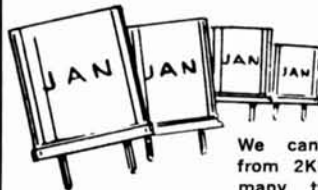

**48 Hr.  
DELIVERY**

We can supply crystals  
from 2KHz to 80 MHz in  
many types of holders.

### SPECIALS

Color TV crystal (3579, 545KHz) wire leads	\$1.60	4 for \$5.00
100KHz freq. std. crystal (HC13/U)	4.50	
1000 KHz freq. std. crystal (HC6/U)	3.50	
Any CB crystal TR. or REC.	2.25	
Any amateur band crystal (except 80 meters) in FT-243 holders	1.50	or 4 for \$5.00
Any marine frequency (HC6/U)	2.85	
80 meter — FT-243 holders	2.50	

We have in stock over six million crystals which include types CR1A/AR, FT243, FT241, MC7, FT249, HC6/U, HC13/U, HC25/U, HC18/U, etc. Send 10¢ for our 1970 catalog with oscillator circuits, listing thousands of frequencies in stock for immediate delivery. (Add 10¢ per crystal to above prices for shipment 1st class mail, 15¢ each for air mail).



Special Quantity Prices to  
Jobbers and Dealers.

**ORDER DIRECT**  
with check or money order  
to

2400 Crystal Drive  
Fort Myers, Florida 33901

## W2AU BALUN LETS ENTIRE ANTENNA RADIATE!

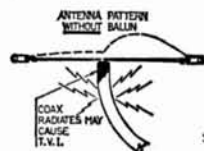
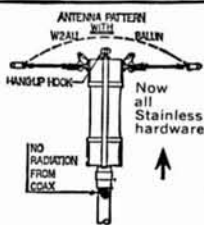

STOP WASTING YOUR SIGNAL!  
REMEMBER, YOUR ANTENNA  
IS THE MOST IMPORTANT  
PIECE OF GEAR YOU OWN.

- No Radiation from Coax
- No Center Insulator Needed
- Perfect for Inverted Vees (Use Hang-up Hook)
- Built-in Lightning arrester
- Broad Band 3 to 40 mc.
- Takes Legal Power Limit and then some
- Two Models:
  - 1:1 50 ohm coax to 50 ohm balanced
  - 4:1 75 ohm coax to 300 ohm balanced
- A must for Inverted Vees, Doublets, Quads, Yagis and Multiple Dipoles.

**\$12.95** AMATEUR  
NET

See QST and May 73  
for more details

W2AU Complete pretuned Fiberglass Quad — **\$99.95**  
W2AU Complete pretuned Vinyl Quad — **\$64.95**

UNADILLA RADIATION PRODUCTS  
Unadilla, N. Y. 13849 607-369-2985



KEEP UP TO  
DATE ON  
YOUR DXING

A weekly magazine (16 to 24 pages each  
week.

Current DX that's on the air, and info about  
what's planned for the immediate future.  
What's being heard by the boys. Etc.

FULL DX INFO EVERY WEEK.

Per year—Surface mail (they say most  
1st class mail actually goes via air) \$11.00

**The DXERS Magazine, (W4BPD)**

Route 1, Box 161-A,  
Cordova, S.C. 29039

REVIEWED IN DECEMBER, 1968 HAM RADIO

## the permaflex key



- both a twin lever & straight hand key in a pivotless 2 paddle design.
- gives instant choice of automatic semi-automatic & straight hand keying.
- use directly with any transmitter or through an electronic keyer.
- 8 amp. gold diffused silver contacts adjust from 0-.060" & 5-50 grams.
- distinctive blue paddles are of rugged G-10 fiberglass epoxy.
- cabinet is 16 gauge polished chrome steel: 1.95" sq. x 3.75", paddles extend 1.25", weight app. 1 pound.
- silicone rubber feet for stability.
- 100% US made & guaranteed for 1 yr.

**1995** complete,  
ppd usa & can.  
send a check or m.o.  
sold by mail only

**James Research company, dep't: HR-K**  
20 willits rd., glen cove, n.y. 11542

## Antennas Towers Rotators New Used Surplus

We are a member of the Jennings Diode Bank.  
Contact us for any diode.

Service 1/2 amp to 1000 amp any voltage.

HY GAIN · HUSTLER · MOSLEY · EZ WAY  
TRI-EX · ROHN · VESTO · MYLAR  
ROPE · CDR, Etc.

One piece or a complete antenna system  
Also dealing in surplus  
Write for latest catalog

**ANTENNA MART**  
BOX 7 · RIPPEY, IOWA 50235

WE PAY **HIGHEST**  
PRICES FOR ELECTRON  
TUBES AND SEMICONDUCTORS

**H & L ASSOCIATES**

ELIZABETHPORT INDUSTRIAL PARK  
ELIZABETH, NEW JERSEY 07206  
(201) 351-4200

## radio amateur callbook

Radio Amateur  
Emblems engraved  
with your call letters.



*Charm*

Gold  
 Rhodium  
call letters  
\$5.00 Ea.



*Tie Bar*

Gold  
 Rhodium  
call letters  
\$5.00 Ea.



All illustrations  
are actual size.

*Lapel Pin*

Gold  
 Rhodium  
call letters  
\$5.00 Ea.

Rush Order To: **RADIO AMATEUR CALLBOOK, Inc.**  
Dept. E. 925 Sherwood Drive, Lake Bluff, Ill. 60044

## READY FOR 432 MHz?

We are proud to introduce the  line of high performance, high quality equipment for 432 MHz operation.

All units contained in silverplated, brass enclosures. Stripline 432 MHz circuits. Silverplated, glass-epoxy printed circuit boards throughout. All solid-state. From West Germany.

Available from stock! Literature upon request.

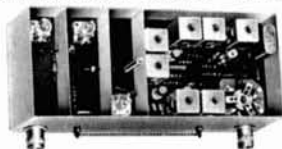

432 MHz Dual Gate MOSFET Converter, Model DGTC 1702. Noise figure: 3.2 I.F. 144-146 MHz ..... \$69.00



144/432 MHz Varactor Tripler, Model LVV 270. AM, FM and CW. Input up to 30 Watts. Efficiency: 50%. Input-frequency suppression: 40 dB min. .... \$75.00



144/432 MHz Transverter, Model TTV 1270. Transmitter input: 50 mW to 1.2 Watts. Efficiency: 60%. Receiver noise figure: 8. No antenna switching required. Simply connects between two-meter AM/FM/CW transceiver and 432 MHz antenna. Requires 12 Volts in "Receive" only ..... \$47.50

**si**

SPECTRUM  
INTERNATIONAL  
TOPSFIELD  
MASSACHUSETTS 01983



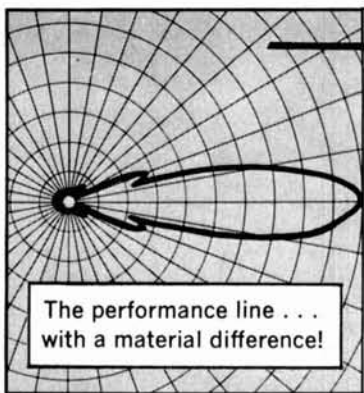

The performance line . . .  
with a material difference!

# telrex

**PREFERRED AND SPECIFIED WORLD-WIDE BY COMMUNICATION ENGINEERS AND ADVANCED AMATEURS**  
Don't settle for anything less than the very best! Use Telrex Communication products — for long lasting optimum performance and value!  
**FREE . . .** Tech data and pricing catalogs describing off-the-shelf and custom-built antennas, systems, "Inverted-vee kits"<sup>®</sup>, towers, mono-poles and rotatable "Berthas".  
For commercial and military applications write for CM69 . . . for amateur applications write for PL69.

COMMUNICATION SYSTEMS SINCE 1921 **telrex** Laboratories ASBURY PARK, NEW JERSEY 07712, U.S.A.

## GET MONEY

Guaranteed top money for any piece of surplus equipment. Payment in 24 hours. We also pay shipping, insurance. Call collect or send list for quick quote. **SPACE ELECTRONICS CORP.** 11 Summit Ave. East Paterson, New Jersey, (201) 791-5050

## WORLD QSL BUREAU

5200 Panama Ave.  
Richmond, Calif. U.S.A. 94804

### PLAN 1

We forward your QSLs (please arrange alphabetically) to or within U.S.A., Canada and Mexico for 3¢ each, and to all other places in World for 4¢ each.

### PLAN 2

You use our special log form and send us a copy. We supply QSL — make out QSL — deliver QSL, all for 8¢ each.

WRITE FOR FREE INFORMATION SHEET

HAVE YOU READ  
**The RSGB VHF-UHF Manual?**  
SEE PAGE 90



**VHF COMMUNICATIONS** is the quarterly magazine for amateurs interested in VHF and UHF technology and equipment construction. It is the international, English edition of the well-known German publication UKW-BERICHTE.

**VHF COMMUNICATIONS** provides sixty pages of modern, but practical construction articles in each issue. Described are transmitters, receivers, converters, transceivers, antennas, test equipment, etc. The designs reflect truly current technology. Solid state devices and printed circuits are used extensively. All mechanical construction data are included. However, for the amateur without fabrication facilities, special components, such as p.c. boards and stripline cavities, are made available, readily and inexpensively.

Subscription rates US \$3.50 (\$4.50 air mail) per calendar year. Single issues \$1.10.

**VHF COMMUNICATIONS**  
TOPSFIELD, MASSACHUSETTS 01983

## HAL DEVICES



**HAL 311B IC KEYER**  
\$43.50 pp

Incorporating all of the features of the HAL IC keyer line, the 311B is the most versatile keyer now available. The 311B offers

- Transistorized output circuit for both grid block and cathode keyed transmitters. Up to 150 v, 500 ma.
- Keyed pulse generator, speed 8-50 wpm.
- Transmitter tune-up switch
- Connection point for straight key
- Rugged G10 glass PC board construction
- Iambic operation for squeeze keying
- Dot memory
- Automatic or semi-automatic operation
- Monitor with tone and volume controls
- Regulated 115 VAC power supply
- Connection point for 3VDC source
- Beige and Walnut grain Designer Cabinet

**HAL Devices**  
P.O. Box 365 H  
Urbana, Ill. 61801

Other models available from \$16.00. Write for details and our listing of other products.

# Stellar

## NEEDS USED GEAR

Top trade in allowances on all major brands of ham equipment.

10 GRAHAM ROAD WEST • ITHICA, N. Y. 14850  
TELEPHONE AREA CODE 607-257-2424

## FREQUENCY STANDARD

The pictured completely assembled and tested printed circuit Frequency Standard, is a must in every Ham station. If you now own a conventional 100KHz calibrator it is inadequate, out of date--but you can salvage your 100KHz crystal and use it with our Model 100-5, or Model 100-25 Frequency Standard to get sharp, accurate markers to keep your receiver-transceiver exactly on frequency.

MODEL 100-25 HAS 3 OUTPUTS: 100, 50, AND 25 KHz.  
PRICE \$12, LESS XTAL, POSTPAID.

MODEL 100-5 HAS 5 OUTPUTS: 100, 50, 25, 10 AND 5 KHz. PRICE \$15, LESS XTAL, POSTPAID.

### SPECIFICATIONS:

1. ALL COMPONENTS ASSEMBLED AND TESTED.
2. GLASS EPOXY PC BOARD.
3. BUILT-IN TRIMMER ALLOWS PRECISE ZERO-BEATING TO WWV.
4. POWER REQUIRED-5VDC AT 130 MA.
5. OUTPUT- 3.8V SQUARE WAVE.
6. VERY COMPACT, ONLY 1.6 X 2.5 INCHES.

GUARANTEE - includes repair or replacement of either unit for 90 days.

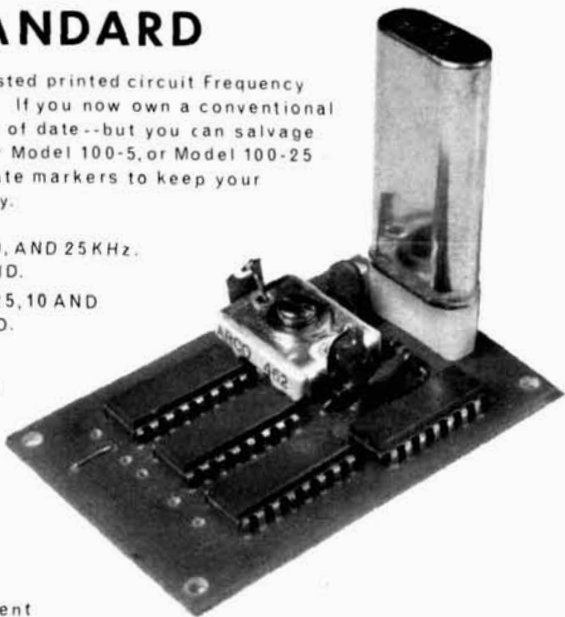

BAKER EX W3ZNI & WINNAY K3KRF  
420 MAPLEWOOD AVE.  
SPRINGFIELD, PA. 19064

radio amateur

# callbook

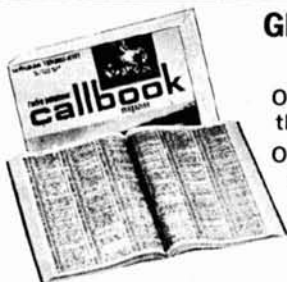

## GET YOUR NEW ISSUES NOW!

Over 290,000 QTHs in the U.S. edition **\$7.95**

Over 140,000 QTHs in the DX edition **\$5.95**

**NEW EDITION EVERY:**  
MARCH 1 — SEPT. 1  
JUNE 1 — DEC. 1

These valuable EXTRA features included in both editions!

- QSL Managers Around the World!
- Census of Radio Amateurs throughout the world!
- Radio Amateurs' License Class!
- World Prefix Map!
- International Radio Amateur Prefixes
- Radio Amateurs' Prefixes by Countries!
- A.R.R.L. Phonetic Alphabet!
- Where To Buy!
- Great Circle Bearings!
- International Postal Information!
- Plus much more!

See your favorite dealer or order direct (add 25¢ for mailing in U.S., Possessions & Canada. Elsewhere add 50¢).

**WRITE FOR FREE BROCHURE!**

RADIO AMATEUR

**callbook** INC.

Dept. E. 925 Sherwood Drive  
Lake Bluff, Ill. 60044

**NOW AVAILABLE**  
**NEW 18th EDITION**  
**W6SAI's**  
**RADIO HANDBOOK**

SEE PAGE 60

## Pro-key Kit



Send perfect morse code — from 5 to 50 words per minute. Excellent to build up your code speed — anyone can send practice code.

- Self-completing characters with automatic character spacing.
- Precision kit includes all parts, such as metal case and printed circuit boards, and detailed, illustrated instructions.
- Pre-assembled keyboard with standard typewriter key arrangement and spacing.
- Special characters included, such as AR, SK, BT, period, comma, question mark, slant bar.
- Self-contained battery operated — two standard "D" cells. All solid state.
- Built-in sidetone and speaker, fast acting relay output.

10"W. 2 1/2"H. 7 1/2"D. **\$149.50** Price (incl. shipping)

**Micro-Z Co.**

Box 2426 Rolling Hills, Calif. 90274



**MIDLAND  
SWR AND  
POWER  
METER**

Reads output and reflected power simultaneously. May be left in line up to 2000 watts. Low insertion loss. Size 5x2x2. Good to 175 Mhz. **PRICE \$15.95, FOB HOUSTON.**

**MADISON ELECTRONICS SUPPLY**

1508 McKinney — HOUSTON, TEXAS 77002  
(713) 224-2668

## THE NEW "BOOMERANG II" 80-40 METER TRAP ANTENNA

ALL STAINLESS STEEL HARDWARE

RUN FULL LEGAL POWER

INSTRUCTIONS  
SUPPLIED

104 Ft. LONG

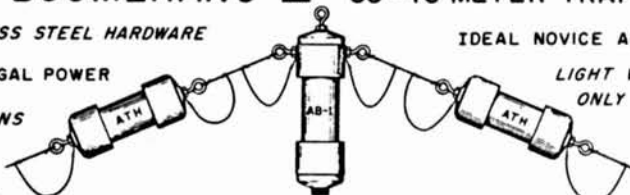

IDEAL NOVICE ANTENNA

LIGHT WEIGHT  
ONLY 4 oz. PER TRAP

MAY BE USED WITHOUT BALUN BUT 1:1 BALUN IS  
RECOMMENDED FOR BEST PERFORMANCE

DEALER INQUIRIES INVITED

LITERATURE ON REQUEST

PRICE: AB-1 1:1 BALUN \$10.95 PPD  
ATH TRAPS PAIR \$12.95 PPD  
ATH TRAPS AND AB-1 BALUN \$22.95 PPD

ORDER FROM: M. WEINSCHENKER K3DPJ  
BOX 353  
IRWIN, PA. 15642

# vhf-uhf manual

BY G.R.JESSOP, C.Eng., MIERE, G6JP

published by the Radio Society of Great Britain

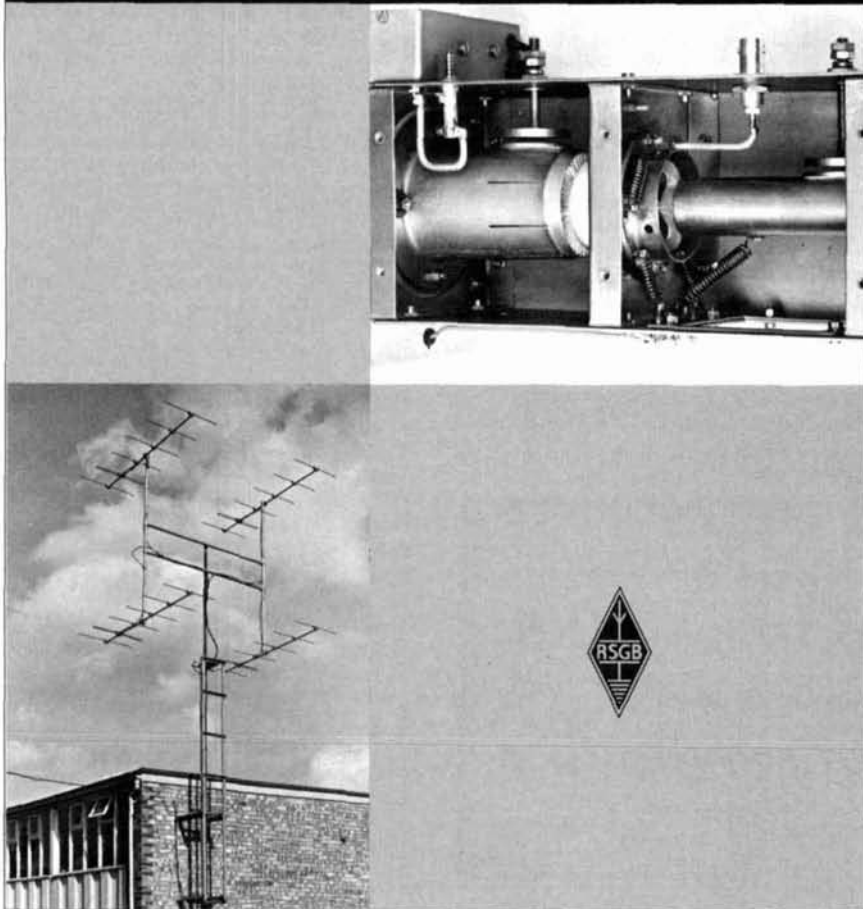

If you have any interest in the frequencies above 30 MHz then you need this book. It is probably the most comprehensive work of its kind ever produced, ranging from advanced material to simple circuits for the beginner to vhf. An attractive layout and clear style make the VHF/UHF Manual a most worthwhile addition to your library.

book division **3.75 postpaid**  
**comtec**

Box 592 • Amherst, New Hampshire 03031

"WE ARE THE EXCLUSIVE NORTH AMERICAN DISTRIBUTOR FOR RSGB PUBLICATIONS —  
DEALER INQUIRIES INVITED"

### TACHOMETER KITS

We bought a large quantity of Tachometer meter movements and dials as shown, and while we were wondering how to sell them, one of our customers showed us some ingenious Tachometers he developed, using this meter movement. We bought the designs and are offering them to you as kits of electrical parts only, which we are selling at far below the price of the meter alone.



**KIT 1** — Tachometer and dwell meter, operates from distributor of 4, 6 and 8 cylinder engines. Transistorized ..... **TK1 \$5.00 ppd.**  
**KIT 2** — Outboard motor, engine tachometer. Simply hold wire lead near spark plug wire and pulses are picked up and registered. Works on 2 or 4 cycle 1, 2, 4, 6 or 8 cylinder engines. Transistorized ..... **TK2 \$12.50 ppd.**  
**KIT 3** — Photo electric tachometer. This is very ingenious. Point the pickup head at propeller of model airplane, or other rotating parts and meter registers RPM by measuring frequency of interrupted light. **TK3 \$12.50 ppd.**

### TRANSISTOR POWER SUPPLIES



Left illustration — Technipower 20-24 volt 3.0 ampere variable supply size 6 1/2" x 7 1/2" x 5" approx. Removed from new equipment. Last price \$180.00 **Tech P.S. 1 \$27.50**

Same spec's as above except 6.0 amperes, size approx. 8" x 9" x 6". **Tech P.S. 2 \$47.50**  
 Right illustration — Sola constant voltage regulated supply, 15 volts at 15 amperes, unused, but may have slight rust spots which will not impair electrical performance. **SCVPS15 \$37.50**

Same spec's but 15 volts, 10 amperes and 5 volts, 15 amperes outputs. **SCVPS155 \$49.50**  
 Not illustrated — Atlas controls +12 volts at 50 amperes and -52 volts 10 amperes variable ±15%. Size 18" x 7 1/2" x 10", about 75 lbs, with Buss bar connections on one end. Only four available. **ACPS \$60.00**  
**Power Supplies Shipped Freight Collect**

### TANTALUM CAPACITORS



Buy these brand new Tantalum Capacitors for less than the price of equivalent aluminum foil units, and get high reliability, infinite life, small size,

and high temperature performance in the bargain. The regular price of these units is from 10 to 20 times our low price.

Left..... 25 MFD @ 180 Volts ..... **\$1.75 ppd.**  
           8 MFD @ 270 Volts ..... **\$1.50 ppd.**  
 Center..... 3.9 MFD @ 75 Volts ..... **3/\$1.00 ppd.**  
 Right..... 400 MFD @ 75 Volts ..... **\$2.00 ppd.**  
           1000 MFD @ 50 Volts ..... **\$3.00 ppd.**  
 Middle..... 26.5 MFD @ 30 Volts, Non polar ..... **\$1.00 ppd.**  
           2 MFD @ 100 Volts ..... **3/\$1.00 ppd.**  
 Bottom..... 1 MFD @ 75 Volts ..... **4/\$1.00 ppd.**

### PRINTED CIRCUIT CARDS

Make your own printed circuit cards. We provide a 4" x 5" double copper clad card and an 18 pin connector (used). ..... **ECPCB \$1.00 ppd.**

### UNIVERSAL LOGIC CIRCUIT CARDS



Instant  
 logical-I-I  
 for  
 10 pin  
 TO-5  
 or  
 14 lead  
 dual  
 in-line



### INTEGRATED CIRCUITS

These boards are the most useful items we have ever offered for breadboarding with low cost integrated circuits. The cards are made from 1/16" G-10 Glass Epoxy, with pads for 14 lead dual in-line mounting pads on one side and 10 lead TO-5 pads on the other. 8 lead TO-5 cans will mount in the 10 lead TO-5 pads also. Discrete transistors and components can be mounted in the locations between the I.C.'s power supply leads are already routed around the board. Our competitors charge \$9.50 each for circuit card and mating connector. We give you a surplus, unused p.c. board with components on it (that you can keep for your junk box), a connector and its mate, and our great circuit card. You drill out the desired hole pattern, unsolder the connector from the surplus card and install it on the new card, wire in the I.C.'s and compute. A few minutes of your time, and you save over 80% of the cost of comparable p.c. cards. Get enough for your breadboarding needs now because these are going to go fast.

2 Cards & mating connectors 2 ICs ..... **\$ 2.50 p.p.**  
 10 Cards & mating connectors 10 ICs ..... **\$10.00 p.p.**  
 100 Cards & mating connectors 100 ICs ..... **\$88.00 p.p.**

### EXPOSURE METER CONTROL



2/\$2.00  
 This little unit lights up a lamp when illumination is below predetermined threshold. Contains high sensitivity CDS photodetector, transistor, potentiometer, lamp and relay. About the size of a quarter. May require relay adjustment to work properly. Complete with circuit applications and design data information. **EMC 2/\$2.00 ppd.**

### LARGER SIZE BOARD 3" x 4"



Circuit on one side only, with space for more components. Same connector and salvage board as above provided.

**CB8TO5** — Pattern for nine 8 pin TO-5 cans, (shown) order #CB8TO5 — (quantity ordered)  
**CBDIP** — Pattern for nine dual-in-line I.C. packages (shown) order #CBDIP — (quantity ordered)  
**CBFP** — Pattern for nine flat packs, order #CBFP — (quantity ordered)  
**CB10TO5** — Pattern for nine 10 pin TO-5 cans, similar to our ILCB style, order #CB10TO5 — (quantity ordered)  
**PRICES (mixed, any quantity of each type)**

(Part No.)—2  
 2 Boards & Connectors ..... **\$3.50 ppd.**  
 (Part No.)—10  
 10 Boards & Connectors ..... **\$15.00 ppd.**  
 (Part No.)—100  
 100 Boards & Connectors ..... **\$125.00 ppd.**

**SEND 25¢ FOR OUR LATEST, BEST CATALOG YET, JAM PACKED WITH ELECTRONIC BARAINS . . . FREE WITH AN ORDER . . .**



**Enterprises**

P. O. BOX 44, HATHORNE, MASS. 01937

## Regul. Pwr Sply for Command, LM, Etc.

PP-106/U: Metered. Knob-adjustable 90-270 v up to 80 ma dc; also select an AC of 6.3 v 5A, or 12.6 v 2½ A or 28 v 2½ A. With mating output plug & all tech. data. Shpg. wt. 50 lb. **19.50**

BARGAINS WHICH THE ABOVE WILL POWER:

LM-(\*) Freq. Meter: .125-20 mhz, .01%, CW or AM, with serial-matched calib. book, tech. data, mating plug. Checked & grtd. **57.50**  
 TS-323 Freq. Meter: Similar to above but 20-480 mhz. .001%. With data. **169.50**  
 A.R.C. R11A: Modern Q-5'er 190-550 khz **12.95**  
 A.R.C. R22: 540-1600 khz w/tuning graph **17.95**  
 A.R.C. R13B: 108-132 mhz w/tuning graph **27.50**

## High-Sensitivity Wide-Band Receiver

COMMUNICATIONS . . . BUG DETECTION  
 SPECTRUM STUDIES

38-1000 MHZ: AN/ALR-5 consists of a brand-new Tuner/Converter CV-253/ALR in original factory pack and an exc. used, checked OK & grtd. main rcvr R-444 modified for 120 v, 50/60 hz. The tuner covers the range in 4 bands and each band has its own Ant. input plug (type N). Packed with each tuner is the factory checkout sheet. The one we opened showed SENSITIVITY: 1.1 uv at 28.2 mhz, 0.9 at 133 mhz, 5 at 538 mhz, 4½ at 778 mhz, 7 at 1 ghz. The rcvr. is actually a 30 mhz IF ampl. with all that follows an IF, including an S meter. Has Pan, Video & AF outputs. Has a calibrated attenuator in 6 db steps to -74 db, also AVC position. Select pass of -200 khz or -2 mhz. AND SELECT AM OR FM! We furnish Handbook & pwr-input plug, all for **275.00**

R-390/URR Receiver: Two coming in, checked 100% perfect and grtd., with books. SUBJECT TO PRIOR SALE! Each **795.00**

R-595/ARR-7AX: Double-conversion version of the popular R-45; cascode input ckt; 550 khz to 43 mhz. With pwr. sply, ready to use, OK grtd. **190.00**

## Versatile Plate & Filam. Transformer

Depot Spares for SP-600-JX: Pri. 95/105/117/130/190/210/234/260 v 50/60 hz. Sec. 1: 305-0-305 v, 150 ma. Sec. 2: 5 v 3 A. Sec. 3: 6.3 v 5A. Sec. 4: 7½ v, 3/4 A. Sec. 5: 7½ v, 1¼ A. Legend for pins is plainly marked. Herm. sealed. **2.95**

We probably have the best inventory of good lab test equipment in the country. Scopes, Signal Generators, VTVM's, DVM's, RFI Meters, etc., etc. But, please do not ask for catalog! Ask for specific items or kinds of items you need! We also buy! What do you have? Right now we need some Beckman #7370 Counters, for example.

## R. E. GOODHEART CO. INC.

Box 1220-HR, Beverly Hills, Calif. 90213  
 Tel: Area 213, office 272-5707, messages 275-5342

. . . THE BEST

## 2 METER CONVERTER

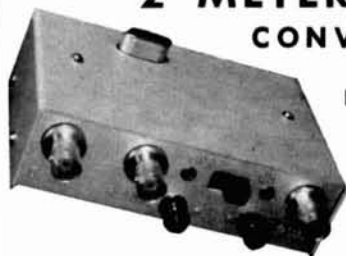

Model 407  
**\$34.95**  
 ppd.

144-146 MHz in. 28-30 MHz out  
 or 146-148 MHz with a second crystal  
 available for \$3.95 extra

A full description of this fantastic converter would fill this page, but you can take our word for it (or those of hundreds of satisfied users) that it's the best. The reason is simple - we use three RCA dual gate MOSFETs, one bipolar, and 3 diodes in the best circuit ever. Still not convinced? Then send for our free catalog and get the full description, plus photos and even the schematic.

Can't wait? Then send us a postal money order for \$34.95 and we'll rush the 407 out to you. NOTE: The Model 407 is also available in any frequency combination up to 450 MHz (some at higher prices) as listed in our catalog. New York City and State residents add local sales tax.

## VANGUARD LABS

Dept. R, 196-23 Jamaica Ave., Hollis, N.Y. 11423

## MILITARY TECHNICAL MANUALS

MANUALS ON SURPLUS ELECTRONIC EQUIPMENT, SEND US YOUR REQUIREMENTS FOR QUOTE. NO LISTS.

SLEP ELECTRONICS CO.

BOX 178H, 2412 HIGHWAY 301 N  
 ELLENTON, FLORIDA 33512 PHONE (813) 722-1843

## BARRY PAYS CASH FAST

You can be sure with Barry . . .  
 Fair dealing since 1938

Send lists of your unused TUBES,  
 Receivers, Semi-Conductors,  
 Vac. Variables, Test Equipment, etc.

No Quantity too Small.  
 No Quantity too Large.

Write or Call now . . . BARRY, W2LNI

## BARRY ELECTRONICS

512 BROADWAY • NEW YORK, N. Y. 10012  
 212 - WA 5-7000

## DIODES

PIV	EPOXY			STUD.
	TOP-HAT 1.5 AMP	1.5 AMP	3 AMP	MOUNT 6 AMP
50	.04	.06	.12	.15
100	.06	.08	.16	.20
200	.08	.10	.20	.25
400	.12	.14	.28	.50
600	.14	.16	.32	.58
800	.17	.20	.40	.65
1000	.20	.24	.48	.75

PRICES PPD. U. S. A.

PA. RESIDENTS ADD 6% PA. SALES TAX

M. WEINSCHENKER K3DPJ

PO BOX 353, IRWIN, PA. 15642

### 5 LEVEL TAPE READER

Made for teletype use but we have been advised they are just as useful for other methods of data transmission when tied in with computers. Removed from used equipment. Last time offered, they sold out in one advertising.  
order TAPE READER \$15.00



### 16 BIT SCRATCH PAD MEMORY

4 x 4 matrix, 4 inputs "X", 4 inputs "Y", Dual inline package ..... #AACVI \$2.75

### FOUR 2-INPUT "AND" GATES, "OR'D" TOGETHER, BUFFERED & INVERTED

Dual inline package ..... #AAB3 \$1.75

### SYNCHRONOUS RICELESS FLIP-FLOP

may be converted to most any flip-flop mode (R.S. D, J.K., etc.) 4 separate 2-input AND gates. "OR'd" together & fed to universal flip-flop. Dual inline package ..... #AAFLI \$3.00

### DUAL 4-INPUT GATE W/EMITTER FOLLOWER RESISTORS

Dual inline package ..... #F1116 \$1.00  
12 for \$10.00

### DECODER LAMP DRIVER HIGH CURRENT

Similar to Fairchild SH2001. Dual 2-input gate w/amp. 14 pin dual inline ceramic package. #SHO-579 \$2.25

### TUBES TUBES TUBES TUBES

Used, guaranteed OK condition.  
4X150 ..... \$4.00  
813 ..... 5.00  
6146 ..... 2.00

### 2N706A HI-FREQ. TRANSISTORS

First line factory marked, 400 mc. 15 volt, NPN #2N706A 3 for \$1.00

### SAPPHIRE ROD

Pure sapphire rod, 1 inch long x 1/16 diameter polished each end and sides. Cuts glass, used for bearings, end-window for UV or IR, etc. \$1.25 each

### FIBRE OPTICS KITS WITH IMAGE TRANSMITTER

An experimenters delight, fantastic display of the unique properties of clad-fibre-optics to pipe light as well as images. Kit #1 includes PVC sheathed bundle of glass fibres with polished ends (light pipe), bundle of plastic fibre optics, bundle of glass fibres, coherent light pipe (transmits images), instructions & experiments.  
BLISS-FULL PAK #1 \$5.00

Kit #2 includes all of the above but more fibres, longer lengths, fatter bundles and also includes light source, heat shrink tubing, a 5 ft. light pipe, a longer coherent bundle (image transmitter) & more experiments.  
BLISS-FULL PAK #2 \$10.00

### RECORDING MICRO BAROGRAPH

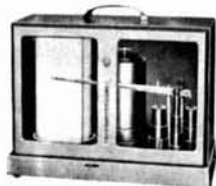

Surplus U. S. Air Force Bendix-Friez recording barograph. The standard instrument for U. S. Weather Bureau, armed forces

airlines. Records a full week, powered by a jeweled spring-driven clock mechanism. A valuable instrument for the yachtsman or anyone interested in weather variations. An unusual gift for "the man who has everything." These are checked out, with a year's supply of ink and charts. Should last a lifetime. Gov't cost \$367.00. Our price ..... \$125.00 plus shipping.

### FIBRE OPTIC LIGHT PIPE

1 ft. length jacketed glass fibres (200 fibres) each end sealed and optically polished for maximum light conduction. Pipe light around corners, into difficult locations, etc.  
#LP-1 \$1.00

### BULK LIGHT PIPE

3 feet of fibre glass (200 fibres) with jacketing. Make your own light pipes, Christmas tree displays, psychedelic lighting, etc. Any length you wish at 3 feet for \$1.00.

### FIBRE OPTIC OPTICAL SCANNER \$5.00

Photo optics scanner, as used in IBM punch card scanner system. We offer the 12 position optical scanner consisting of 2 ft. assembly light pipe fanning out into a 12 channel scanner. All terminations optically polished. Make your own card scanner, light chopper, etc. A value for the 22 inch light pipe alone. With 4 page evaluation & application data.  
#LP-3 \$5.00

### IBM WIRED MEMORY FRAMES

Removed from high priced computers. ExInt condition.  
640 Wired Core Plane \$ 5.00  
4,000 Wired Core Plane \$ 9.00  
4,096 Wired Core Plane \$12.50  
8,000 Wired Core Plane \$13.50  
8,192 Wired Core Plane \$15.00  
16,384 Wired Core Plane \$19.00

GIANT VALUE

### INTEGRATED CIRCUITS

900 Buffer ..... \$1.00  
910 Dual 2-input NOR ..... 1.00  
2-903 Dual input gate ..... 1.00  
914 Dual 2-input gate ..... 1.00  
914-925 Dual 2-input gate dual expander ..... 1.00  
923 JK flip flop ..... 1.00  
925 Dual 2-input gate exp. .... 1.00  
926 Hi-Speed flip flop (TO-5) ..... 1.50  
946 DTL 4 2-input NAND/NOR gate ..... 2/1.00  
DTL Clocked flip flop ..... 2/1.00  
1M5 Dual 4-input logic gate ..... 2/1.00  
7M6 6 NPN transistors in one package, gen. use ..... 3/1.00  
12M2 Diff. Amp ..... 1.00  
711 Dual Comp. Amp ..... 2.00

Above equipment on hand, ready to ship. Terms net cash, f.o.b. Lynn, Mass. Many other unusual pieces of military surplus electronic equipment are described in our catalog.

Send 25¢ for catalog #70

## JOHN MESHNA JR.

19 ALLERTON ST., LYNN, MASS. 01904  
P. O. BOX 62, E. LYNN, MASS. 01904

# DX-ARRAY

NEW 20 ELEMENT  
ANTENNAS

# Advertisers iNdex

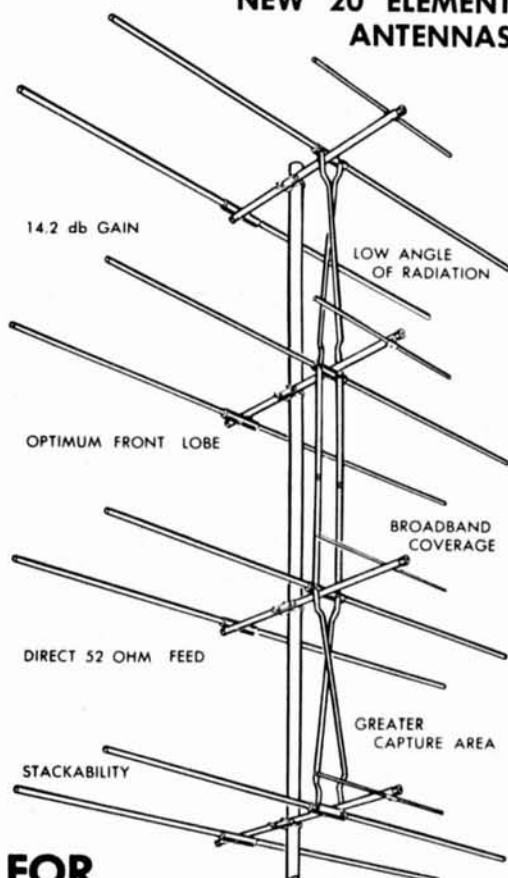

**FOR**  
**144 mhz 220 mhz 432 mhz**

A breakthrough in VHF/UHF Amateur antennas! The new Cush Craft DX-Arrays combine the best yagi and colinear features into the World's most advanced amateur communication antennas.

Realizing that the antenna is the most important part of your station, Cush Craft engineers have devoted two years of intensive development and testing to perfect DX-Array. DX-Arrays have already established new records in Dx-ing and moonbounce programs.

Whatever your interest may be, ragchewing, contests, DX, or moonbounce, get in on the excitement of VHF hamming today with DX-Array.

**DX-120 — 144 mhz \$29.50**

**DX-220 — 220 mhz 22.50**

**DX-420 — 432 mhz 17.50**

See your local distributor or write for complete specifications on these exciting new antennas from the world's leading manufacturer of UHF/VHF Communication Antennas.

**Cush Craft**

621A HAYWARD STREET  
MANCHESTER, N. H. 03103

Antenna Mart .....	86
B & F Enterprises .....	91
Baker & Winnay .....	88
Barry Electronics .....	92
Bob's Amateur Electronics .....	65
Collins Radio Co. ....	Cover II
Communications Technology, Inc. ....	60, 79, 90
Curtis Electro Devices .....	84
Cushcraft .....	94
Dames Co., Ted .....	76
DXer's Magazine .....	85
Electro-Voice, Inc. ....	Cover IV
Goodheart Co., Inc., R. E. ....	92
Gordon Co., Herbert W. ....	96
H & L Associates .....	86
HAL Devices .....	87
Ham Radio Magazine .....	43, 47
Hammarlund Manufacturing Co. ....	2
Henry Radio .....	5
International Crystal Manufacturing Co. ....	7
James Research .....	84, 85
Jan Crystals .....	85
L.A. Amateur Radio .....	95
Madison Electronics Supply .....	89
Meshna, John, Jr .....	93
Micro-Z Co. ....	89
Military Electronics Corp. ....	87
Mosley Electronics Inc. ....	73
National Radio Co., Inc. ....	59
Palomar Engineers .....	82
Phase Corp. ....	80
RCA Institutes .....	51
Radio Amateur Callbook, Inc. ....	84, 86, 89
Radio Shop, Lab 1 .....	83
Saroc .....	78
Signal/One .....	69
Slep Electronics .....	92
Spectronics .....	Cover III
Spectrum International .....	86
Stellar Industries .....	88
Structural Glass .....	82
Swan Electronics .....	27
Telrex Communication Engineering Laboratories .....	87
Unadilla .....	85
VHF Associates .....	85
VHF Communication .....	87
Vanguard Labs .....	92
Varitronics, Inc. ....	1
Weinschenker, M. ....	89, 92
World QSL Bureau .....	87



## TWO STORES TO SERVE YOU

New Address:

### L. A. AMATEUR RADIO

24214 CRENSHAW BLVD.  
TORRANCE, CALIF. 90503  
Phone 534-4456

### EVANSVILLE AMATEUR RADIO

1311 NORTH FULTON AVE.  
EVANSVILLE, INDIANA 47710

— BIG CASH DISCOUNTS EVERYDAY —

HAM & C.B.  
HEADQUARTERS

SAVE UP TO 15%  
ON PACKAGE DEALS

MON., WED., FRI. — 10-6:00 p.m.

TUE., THUR. — 10-8:00 p.m.

SAT. — 10-6:00 p.m.

## SPECIALS OF THE MONTH

NEW — Ham/M (reg. \$129.95)	\$99.95
NEW — TR-44 (reg. \$59.95)	\$59.95
DISPLAYED — NEW Swan 500C	\$485.00

Write for Hy-Gain and Mosley package deals

### COLLINS

KWM/2 W/AC Supply, Clean	\$675
75S/1 W/6&2 Xtals & "Q"	299
KWM2 Mobile DC Supply	89
KWM2 Mobile Mount	30

### DRAKE

R4A Very Clean	295
R4B Displayed, New	369
T4XB Displayed, New	389
TR/3, Very Clean	369
TR/4, Like New	449
2A Rcvr, Clean	129
2B Rcvr, Very Clean	179
2BQ With Spkr	20
2AQ With Spkr	15

### GALAXY

GT550 Displayed	389
GAL V, Clean	239
GAL III, Nice	159
GAL MK 3, Like New	299
GAL RV1 VFO, New	59
DuoBander 40/80	109

### HALLICRAFTER

HW 37 Xmtr	175
HT41 Linear, New Tubes	165
HT44 Xmtr	169
HT18 VFO, Clean	20
SR500 TriBander	225
SX100 Rcvr	95
SX101 Mark III	139
SX140 Rcvr, (Novice)	59
S120 SWL Rcvr	20

### HAMMARLUND

HQ110 Rcvr, Clean	95
HQ129X Rcvr	79
HQ 170 Rcvr, Very Clean	150
HQ170/VHF 2Mtrs, Clean	265
HQ170/180 Noise Blanker	35

### MISC. EQUIPMENT

RME 6900 Rcvr 10/80	139
HAM TV Complete	235
SB2LA Linear, Like New	189

### HEATHKIT

SB300 Rcvr, 3 Filters	\$189
SB400 Xmtr, Clean	195
HW32 20 Mtrs, Clean	85
HX10 AM Xmtr SSB	125
HR10 Rcvr (Novice)	55
MR1&MT1 Combo, Works OK	75
DX60A Xmtr (Novice)	50
DX60B Xmtr (Novice)	69

### JOHNSON

Johnson KW Match Box	95
Johnson Ranger II	125
Johnson 6&2 Converter	29

### NATIONAL

NC155 Rcvr, Clean	99
NC12000 Linear	325
NC183D Rcvr, Clean	139
NCX3, Very Clean	150
NCX AC Supply	59
NCX DC Supply	75

### SWAN

Mark II Linear	539
500C Used, Like New	399
500 Used, Very Clean	339
350 Used, Fine Shape	289
260 Displayed, New	379
240 Nice Mobile	149
120 Great Standby	85

### TWO & SIX METERS

Ameco TX62, Clean	109
Gonset Comm-4, 2Mtrs	185
Halicrafter SR42 2Mtrs	119
VHF 126 RME	39
Clegg Apollo 6 Lnr	165
Heath HW17 2Mtrs	99
Heath 2'R, "As Is"	25
Heath HW10 6Mtrs	99
Clegg 99'R 6Mtrs	85
Poly Comm 6Mtrs	119

### C.B. EQUIPMENT

Johnson 350 SSB, Special	\$149
Johnson 320 Reg	\$199
Johnson 323 Reg	239
Johnson 123 Reg	179
Johnson 223 Reg	209
Johnson 100 Reg	129
Johnson III Reg	159

### MIDLAND C.B.

Midland 23Ch #13 875 B&M	149
Midland 5W 6Ch Hand Held	75
Midland 6Ch 5W #13855	69
Midland 23Ch Integrated	120
Midland 23Ch SSB&AM, New	299
Midland 23Ch AM #13890	120

### HYGAIN C.B. ANTENNAS

CLR/2 5/8 Wave Base	29
SDB10 Stack Fives DX'R	135
SDB6 Stack Threes	75
SDB4 Stack Twos	45
QUAD #574 2/Ele Hor/Ver	65
QUAD "BIG GUN", Hot!	125
5/Ele "Long John" 9.7DB	44
3/Ele CB3 Beam 6.8DB	25
"Golden Rod Base Ant"	19
Economy Base - 1/4 Wave	11
Half/Wave Base, CBV	24
Balun Ferrite, BN27A	12
Hygain "On/The/Air" Lite	8
Hygain Dummy Load	2

### ACCESSORIES

Mobile Linear 200 Watts	149
Base Linear AMP 200 Watts	119
500 Watt Base Linear	235
1000 Watt Base Linear	375
2000 Watt Base Linear	695
Drake 2000 Wattmeter	47
Galaxy 3000 Wattmeter	65
GD104 Mike w/Stand	28
Turner plus Base Mike	28
Turner 454X Crystal Mike	18
BTI Linear LK/2000, New	679

CALIF. SALES TAX 5% - FREIGHT F.O.B.  
PRICES SUBJECT TO CHANGE WITHOUT NOTICE

## Concerning **Mosley**



Ever since our beginning, we have felt the need for strong demonstration facilities, not the least of which would be suitable antennas. Four towers supporting forty-four antennas show how serious we are, for an antenna cut to frequency can provide 20 db gain over a random length and this is mighty important when you are trying to prove how effective a piece of equipment can be.

Faced with such a substantial antenna investment we had to decide for ourselves whose product represented the maximum value. Almost every existing design is made by two or more manufacturers in roughly the same price class. What then was the determining element which enabled us to choose our particular radiator.

The service life of the antenna was regarded as the most important parameter. In this connection it is interesting to note that Carl Mosley's products won this test hands down. We have had antennas of his manufacture up in the air for fifteen years with no, I repeat, no service. We have had a TA-36 up for five years behaving as well today as when it was put up. His trap dipoles, such as the TD-2 give a tremendous account of themselves day in and day out and it should be remembered that here in the North East we have some pretty good ice storms and some pretty stiff gales.

A distributor has to sell products for which there is a persistent and continuing demand and Mosley, of course, is only one of several

competitive brands. Mosley leans over backward in trying to express specifications concerning their products. The gain references, for example, are compared to a standard dipole, not the theoretical isotropic dipole which another prominent manufacturer uses as a comparison.

This means that when you compare gain figures you have to subtract approximately 2½ db from this other manufacturer's specs comparing it with Mosley.

This whole subject of antenna measurements is so touchy and causes so much confusion and controversy, that ARRL will not accept advertising in which antenna gain measurements are listed.

I think the conclusion you can draw is that Mosley is conservative and, in addition to being built well and designed well, Carl will not knowingly have any of his products misrepresented. He creates a conservative image of his product and you can believe in what he says.

Because we have been pushing on towers lately, we feel it necessary to point out to our many hundreds of friends that we have the entire Mosley line. We have it in large quantities and we would like nothing better than the opportunity to quote on an antenna package, with or without the tower, and with or without a rotator. So, whether you are interested in a single vertical for these space saving situations, or have a yen for tri-band operation, or want to stack up for points in a contest, Mosley is the brand and we are the place to buy from.

Write in for a Mosley catalog today, or if you have a problem involving your particular situation, address your letter to me personally so I can try to resolve it.

### HERBERT W. GORDON COMPANY

Harvard, Massachusetts 01451 • Telephone 617 — 456 — 3548

*"Helping Hams to Help Themselves"*

**NOW—DIRECT TO THE AMATEUR SPECTRONICS OFFERS THE HIGHEST QUALITY PRE-WIRED EQUIPMENT BELOW KIT PRICES.**

**A FTdx560 TRANSCEIVER**

Successor to the widely acclaimed FTdx400 Transceiver, the new FTdx560 features maximum input power of 560 watts PEP in SSB mode and still maintains  $\frac{1}{2}$  uv receiver sensitivity. Utilizes double conversion tunable I.F. system resulting in drift free operation and maximum image rejection. Velvet smooth planetary dial gearing provides accurate frequency readings to less than 500 Hz. Twenty tubes and forty-two silicon semi-conductors make up the complement of devices used in the FTdx560 Transceiver.

**SPECIFICATIONS:**

Maximum input: 560 W PEP SSB, 500 W CW, Sensitivity: 0.5 uv, S/N 20 db. Selectivity: 2.3 KHz (6db down), 3.7 KHz (50 db down). Carrier suppression: More than 40 db down. Sideband Suppression: More than 50 db down at 1 KHz. Frequency range: 3.5 to 4, 7 to 7.5, 14 to 14.5, 21 to 21.5, 28 to 30 (megahertz). Frequency stability: Less than 100 Hz drift in any 30 minute period after warm-up. Weight 45 pounds.

Only \$449.95

**B SP-560 SPEAKER**

Companion speaker for the FTdx560, specially designed for superb voice quality, finished in matching blue-gray color.

Only \$19.95

**NOT SHOWN:**

FV-400S External VFO — \$99.95  
FLdx2000 Linear Amplifier — \$229.95

**COST COMPARISON CHART**

<b>FTdx560</b>	<b>\$449.95</b>
Built-in AC Power Supply	No charge
Built-in WWV 10 MHz Band	No charge
25 and 100 KHz Calibrators	No charge
VOX	No charge
Clarifier	No charge
Break-in CW with Sidetone	No charge
1 KHz Readout	No charge
Selectable SSB	No charge
One Year Warranty	No charge
<b>YOUR COST</b>	<b>\$449.95</b>

Order direct from your nearest Spectronics Sales and Service Center

**SPECTRONICS WEST**

BOX 338 ■ LAKEWOOD, CALIF. 90714

**SPECTRONICS EAST**

BOX 1457 ■ STOW, OHIO 44224

**New from YAESU  
the FTdx560.**



# JOIN THE ARMY...

the Air Force, the Navy, the Astronauts,  
the FAA, most major airlines,  
police and fire departments,  
and hams

everywhere who've improved their 2-way communications with noise-canceling microphones and handsets from Electro-Voice.

Why do they choose E-V? It is the company that pioneered the noise-canceling principle. And Electro-Voice set the highest standards of reliability, year after year.

To stop noise right at the source, put a dependable Electro-Voice noise-canceling microphone to work today. It can be the start of a quiet revolution!



**ELECTRO-VOICE, INC., Dept. 102HC**  
676 Cecil Street, Buchanan, Michigan 49107

Send me complete information on Electro-Voice microphones for amateur radio.

Name \_\_\_\_\_  
Address \_\_\_\_\_  
City \_\_\_\_\_ State \_\_\_\_\_ Zip \_\_\_\_\_