

ham radio magazine

- 2716 EPROM programmer
- inductance meter
- WPM readout
- active mixers

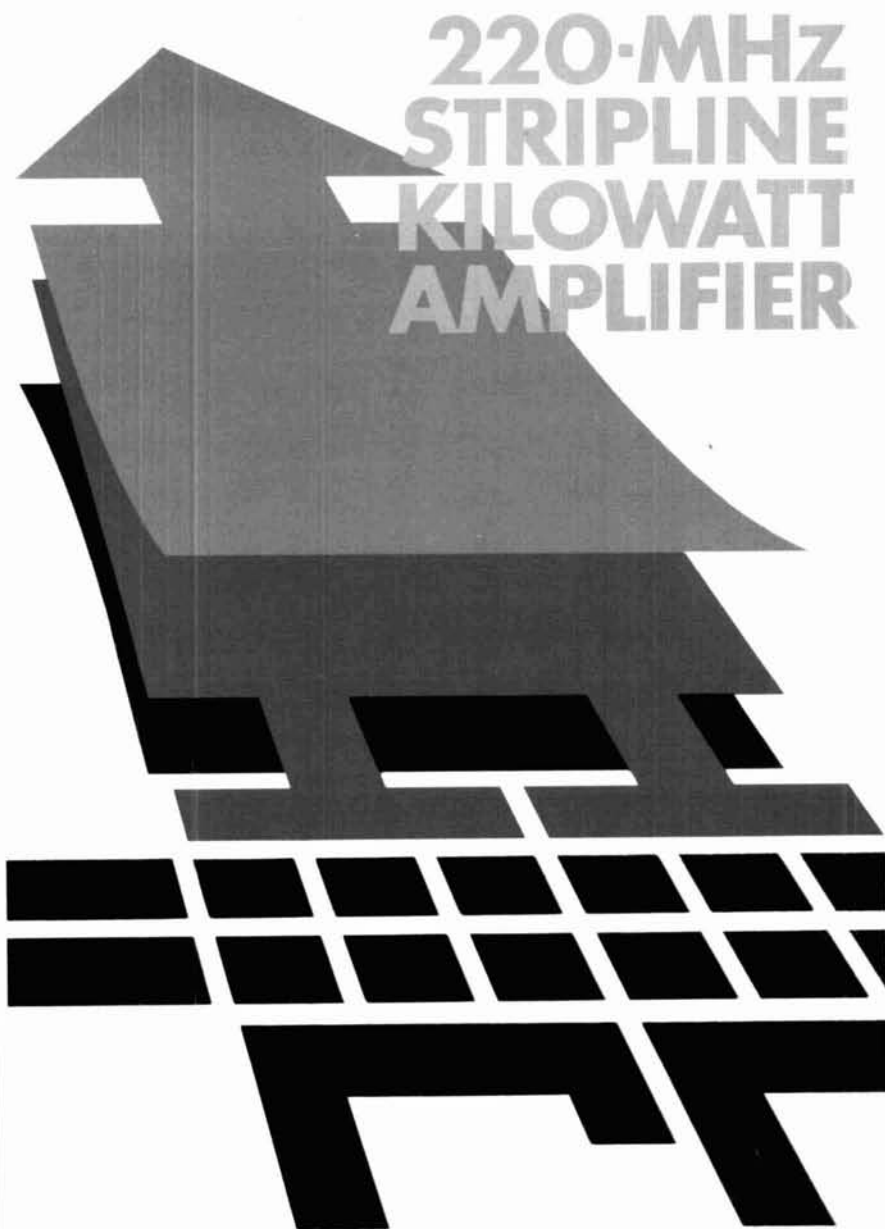

hr 

*focus
on
communications
technology*

ICOM VHF Mobile

Amateur Communications using Space Age Techniques

ICOM's smallest 2 meter FM mobile, the IC-25A offers extremely compact size (5½" x 2" x 7" deep) without sacrificing features: 25 watts, 5 memories, 2 scanning systems, priority channel, 2 VFO's and touchtone™ HM-8 microphone standard.



The best 2 meter multimode mobile on the market today, the IC-290A has features to make multimode mobile a snap. 2 VFO's, 5 memories, priority channel, memory and band scanning, squelch on SSB, selectable AGC and NB and RIT. Touchtone™ encoding provided with HM-8 microphone standard.



6 meter mobile at its best with the IC-560, a multimode mobile transceiver for working FM repeaters or sideband simplex, local or DX, 3 memories, 2 VFO's, scanning, squelch on SSB.



Sensible and affordable, the IC-22U offers simplicity with ease of operation. Easy to use push buttons for up and down tuning. 800 channels at the push of a button. 4 MHz coverage. EX-199 optional remotable frequency selector.

“ . . . (click) . . .
just turned on
the ALPHA . . . ”



Ever notice how many of the really **dominating** signals you hear originate from ALPHAs? You know that a great amplifier alone doesn't guarantee a standout signal. Still, it obviously must be a big step in the right direction.

Of course the ALPHA owner knows that he's stoking the coax with first-rate rf. Perhaps the confidence that he **will get through** on the first call puts that extra crispness and authority into his signal.

And common sense says that anyone with the good judgment to invest his hard-earned money in a superb ALPHA linear isn't likely to tie it to a raunchy-sounding exciter or a wet string dipole.

But in the final analysis, the ALPHA edge is basically simple: maximum clean rf power output, minimum distortion and heat.

For a dozen years, ALPHAs have set the standards by which other

More Details? CHECK — OFF Page 92

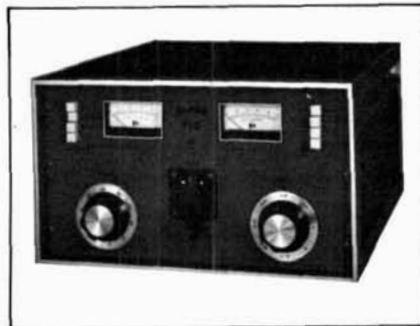

amplifiers are judged — performance, durability, convenience, warranty protection, person-to-person service, resale value. Most ALPHA owners are serious operators, simply unwilling to get along without these legendary ALPHA advantages.

So, if you're tired of being just another voice in the crowd, you're ready for an ALPHA. Sure you can buy a cheaper linear . . . "but is that really what you want?"

Contact your ALPHA dealer or ETO today for full details and specifications.

ETO

Ehrhorn Technological Operations, Inc.
P.O. Box 708
Canon City, Colorado 81212
Phone: (303) 275-1613

The ultimate team... the new

Drake "Twins"



The **TR7A** and **R7A**
offer performance and versatility
for those who demand the ultimate!

TR7A Transceiver

- **CONTINUOUS FREQUENCY COVERAGE** — 1.5 to 30 MHz full receive coverage. The optional AUX7 provides 0 to 1.5 MHz receive plus transmit coverage of 1.8 to 30 MHz, for future Amateur bands, MARS, Embassy, Government or Commercial frequencies (proper authorization required).
- **Full Passband Tuning (PBT)** enhances use of high rejection 8-pole crystal filters.

New! Both 2.3 kHz ssb and 500 Hz cw crystal filters, and 9 kHz a-m selectivity are standard, plus provisions for two additional filters. These 8-pole crystal filters in conjunction with careful mechanical/electrical design result in realizable ultimate rejection in excess of 100 dB.

New! The very effective NB7 Noise Blanker is now standard.

New! Built in lightning protection avoids damage to solid-state components from lightning induced transients.

New! Mic audio available on rear panel to facilitate phone patch connection.

- **State-of-the-art design** combining solid-state PA, up-conversion, high-level double balanced 1st mixer and frequency synthesis provided a no tune-up, broadband, high dynamic range transceiver.

R7A Receiver

- **CONTINUOUS NO COMPROMISE** 0 to 30 MHz frequency coverage.
- **Full passband tuning (PBT).**

New! NB7A Noise Blanker supplied as standard.

- **State-of-the-Art features** of the TR7A, plus added flexibility with a low noise 10 dB rf amplifier.

New! Standard ultimate selectivity choices include the supplied 2.3 kHz ssb and 500 Hz cw crystal filters, and 9 kHz a-m selectivity. Capability for three accessory crystal filters plus the two supplied, including 300 Hz, 1.8 kHz, 4 kHz, and 6 kHz. The 4 kHz filter, when used with the R7A's Synchro-Phase a-m detector, provides a-m reception with greater frequency response within a narrower bandwidth than conventional a-m detection, and sideband selection to minimize interference potential.

- **Front panel pushbutton control** of rf preamp, a-m/ssb detector, speaker ON/OFF switch, i-f notch filter, reference-derived calibrator signal, three agc release times (plus AGC OFF), integral 150 MHz frequency counter/digital readout for external use, and Receiver Incremental Tuning (RIT).

The "Twins" System

- **FREQUENCY FLEXIBILITY.** The TR7A/R7A combination offers the operator, particularly the DX'er or Contester, frequency control agility not available in any other system. The "Twins" offer the only system capable of no-compromise DSR (Dual Simultaneous Receive). Most transceivers allow some external receiver control, but the "Twins" provide instant transfer of transmit frequency control to the R7A VFO. The operator can listen to either or both receiver's audio, and instantly determine his transmitting frequency by

appropriate use of the TR7A's RCT control (Receiver Controlled Transmit). DSR is implemented by mixing the two audio signals in the R7A

- **ALTERNATE ANTENNA CAPABILITY.** The R7A's Antenna Power Splitter enhances the DSR feature by allowing the use of an additional antenna (ALTERNATE) besides the MAIN antenna connected to the TR7A (the transmitting antenna). All possible splits between the two antennas and the two system receivers are possible.

Specifications, availability and prices subject to change without notice or obligation.

See your Drake dealer or write
for additional information.



COMING SOON: New RV75 Synthesized VFO
Compatible with TR5 and 7-Line Xcvrs/Rcvrs

- Frequency Synthesized for crystal-controlled stability
- VRTO (Variable Rate Tuning Oscillator*) adjusts tuning rate as function of tuning speed.
- Resolution to 10 Hz
- Three programmable fixed frequencies for MARS, etc.
- Split or Transceive operation with main transceiver PTO or RV75

SAVE \$13.50* with home delivery

*(One year newsstand cost \$30.00)

Here's my address label, enter my subscription.

- 1 Year 12 issues \$16.50
- 2 Years 24 issues \$28.50
- 3 Years 36 issues \$38.50 U.S. prices

- Payment enclosed
- Bill me later

Name _____

Address _____ State _____ Zip _____

City _____

Check here if this is your renewal (attach label)

Subscribe to **ham radio** magazine

Foreign rates: Europe, Japan and Africa, \$28.00 for one year by air forwarding service. All other countries \$21.50 for one year by surface mail. Please allow 4-6 weeks for delivery of first issues.

Please
enter my
subscription



BUSINESS REPLY CARD
First Class Permit No. 1 Greenville, NH

Postage Will Be Paid By Addressee

**ham
radio**
Greenville, NH 03048

NO POSTAGE
NECESSARY
IF MAILED
IN THE
UNITED STATES



ham radio

magazine

APRIL 1982
volume 15, number 4

T. H. Tenney, Jr., W1NLB
publisher and
editor-in-chief

Alfred Wilson, W6NIF
editor

editorial staff

Martin Hanft, WB1CHQ
production editor

Joseph J. Schroeder, W9JUV
Leonard H. Anderson
associate editors

Susan Shorrock
production

Wayne Pierce, K3SUK
cover

publishing staff

J. Craig Clark, Jr., N1ACH
assistant publisher and
advertising manager

Susan Shorrock
circulation manager

ham radio magazine
is published monthly by
Communications Technology, Inc.
Greenville, New Hampshire 03048-0498
Telephone: 603-878-1441

subscription rates

United States: one year, \$16.50
two years, \$28.50; three years, \$38.50

Canada and other countries (via Surface Mail)
one year, \$21.50; two years, \$40.00
three years, \$57.00

Europe, Japan, Africa (via Air
Forwarding Service) one year, \$28.00

All subscription orders payable in
United States funds, please

foreign subscription agents

Foreign subscription agents are
listed on page 81

Microfilm copies
are available from
University Microfilms, International
Ann Arbor, Michigan 48106
Order publication number 3076

Cassette tapes of selected articles
from ham radio are available to the
blind and physically handicapped
from Recorded Periodicals
919 Walnut Street, 8th Floor
Philadelphia, Pennsylvania 19107

Copyright 1982 by
Communications Technology, Inc.
Title registered at U.S. Patent Office

Second-class postage
paid at Greenville, N. H. 03048-0498
and at additional mailing offices
ISSN 0148-5989

Postmaster send Form 3579 to ham radio
Greenville, New Hampshire 03048-0498



contents

**12 stripline kilowatt amplifier
for 220 MHz**

F. J. Merry, W2GN

26 ham radio techniques

Bill Orr, W6SAI

32 2716 EPROM programmer

C. A. Eubanks, N3CA

**38 performance capability of
active mixers**

Dr. Ulrich L. Rohde, DJ2LR

**50 readout for the
deluxe memory keyer**

Vernon W. Smith, WA10EH

**56 operation upgrade:
part 6**

Robert L. Shrader, W6BNB

76 inductance meter

Ed Marriner, W6XM

92 advertisers index

8 comments

70 DX forecaster

81 flea market

62 ham calendar

74 ham mart

66 ham notes

85 new products

**7 observation and
opinion**

10 presstop

92 reader service

50 weekender

WE BACK EVERYTHING
WE SELL WITH OUR
PERSONAL GUARANTEE

PRICES F. O. B.
HOUSTON

PRICES SUBJECT TO
CHANGE WITHOUT
NOTICE

ITEMS SUBJECT TO
PRIOR SALE

MADISON Electronics Supply



HANDIE HEAVEN

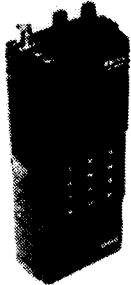

IC2 AT
269.95

Madison's
Price
249.00

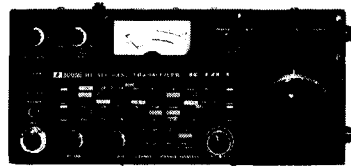

IC-720A ICOM

ICOM's top of the line - 9 band HF transceiver, general coverage receiver - 0.1 MHz to 30MHz, 12 VDC operation (compatible with PS15 power supply). 2 VFO's builtin.

LIST
\$1498 w/AC
Madison's
Price
\$1298 w/AC

NEW NIGHT LINE
TOLL FREE
1-800-231-3057
MON, WED, FRI 7 PM-10 PM CT

IF IT'S
NOT LISTED,
CALL ME!!



IC-730



829.00 LIST
699.00 Madison Price

- Great Filter Options
- 9 Band Coverage
- 200 Watts PEP Input
- Electronic Lock
- One Memory Per Band
- Dual VFO's

NEW
IC3AT
220 mHz
or
IC4AT
440 mHz
\$299.00
W/Pad
Madison's
Price
269.00

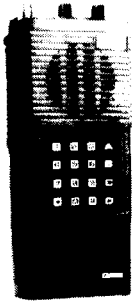

DONS CORNER?

Time to answer some mail . . . **Service Department** has a complement of technical abilities. Al, WB5AYF, is a 20 year man at NASA and one of the best digital men in the country. Steve, W5EGP, knows tube sets from Kenwood and Yaesu to National. Bill, W5SG, is our Collins expert. He used to work for Rockwell. Kirby, K7WOC, our resident airline pilot, is strong in trouble shooting, and Rod, K5BGB, is our "clean-up" man. He can solve problems that sometimes even the factory has trouble with. Try us first, or last. But, try us!

Discounts — Even on hard to find items, we discount below list to build volume.

Refunds — If it's clean, we won't argue if it is returned within 2 weeks.

Questions — The mountain of questions we get by mail is impossible to handle. If you have a question, call! Ask an intelligent question, get an intelligent answer. Ask a stupid question, we'll still try to give an intelligent answer.

Out of Stock — I don't hesitate to refer you to dealers that carry an item I am out of or don't handle. We want your good will.

Go to the Top — If a problem isn't being handled, call and ask for me, DON, K5AAD. The buck stops here.

FREEBEE! Buy any HF Transceiver, and pick any one upgrade book from BASH, AMECO or ARRL. Extras can have that, or any book up to \$10.00 in value.

'til next time, Don

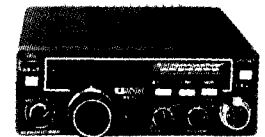

Madison's
Price
IC-25A
LIST \$349 \$309

ICOM's small size (only 5 1/2" wide) 2 meter FM transceiver. Featuring 25 W. out, Priority channel, scanning, 5 memories. Touchtone™ mic standard at no extra cost.

ACCESSORIES

- PS15 — 149.00
(Fits 720 or 730)
- BP4 — 12.50
- BP5 — 49.50
- BC30 — 69.00
- FL30 — 59.50
- FL44 — 144.00
- FL45 — 59.50



Madison's
Price
IC-22U
\$299 LIST \$269

2 meter, FM, 10W, 800 channel, synthesized. Frequency selection remotable with EX199 adapter. Compact, easy to use, affordable.

BELDEN

RG8/u Dbl Shield	Part Number 9888	65 c/ft	No. of Cond — 8	8448	27 c/ft.
RG8/u Foam 81VF	8214	36 c/ft	AWG (in mm) — 6-22 (7 x 30)		
RG8/u Regular 66VF	8237	32 c/ft	2-18 (16 x 30) (1 19)		
RG 213 Non-contaminating	8267	43 c/ft.	No. of Cond — 8 AWG (in mm) 2-16 (26 x 30)	9405	45 c/ft.
			6-16 (16 x 30). (1 17)		

Belden Mini RG-8 (9258)-19c/ft.



Madison's
Price
IC-290A
LIST \$549.00 \$489

2 meter multimode mobile, 12 VDC, 10 W. out, FM, 5SB, CW, Priority channel, scanning, CW sidetone, squelch on 5SB.

713-658-0268

* CALL FOR QUOTES

1508 MCKINNEY
HOUSTON, TEXAS 77010

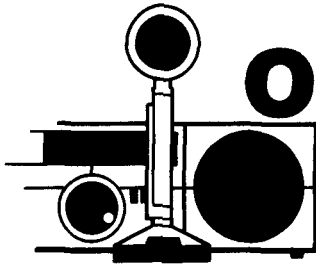

Observation & Opinion

During my ham career, I have always been an enthusiastic member of the DX fraternity. I've been through more sunspot cycles than I care to remember, always trying to increase my DXCC country total, and I have managed to accumulate a fairly respectable number of confirmed contacts. All this took place when I was in California. There I had all the trappings considered necessary to compete with the big guns in kilowatt alley and was able to hold my own pretty well in the pile-ups. However, things have changed — and for the better, I might add.

My move from California to New Hampshire required that I put all my ham gear, some 35 years' accumulation, in storage, where it still remains. But strangely enough, I don't really miss it. I've rediscovered a new and far more challenging pursuit, one that I followed only casually in California — the world of QRP, or low-power operation.

With the kind help of Skip Tenney, I was on the air with borrowed equipment and a longwire antenna shortly after I arrived in New Hampshire. The gear was nothing exotic — just a good high-frequency transceiver with adjustable power output and a few accessories. My experience with this borrowed rig, operating from a good location (for a change), has been most rewarding. It's altogether a different game chasing DX stations when you don't have a big antenna and a kilowatt amplifier.

The term QRP is from the international list of Q-code signals and means *reduce power*. QRP operation in the Amateur bands has several definitions, depending on whom you talk to. To some, anything below 100 watts is QRP. However, true QRP is generally recognized as an input power of 10 watts or less, and 1 watt or less is called QRP_p. With a good antenna and only a few milliwatts, tremendous distances can be covered in the high-frequency bands. But this kind of achievement is possible only with skillful operating and, above all, patience and perseverance.

A certain etiquette and some unwritten rules prevail among the QRP brethren. These have evolved over the years and are generally accepted by serious operators. For example, it's not considered good form to make contact with high power then ask the station to listen for your QRP signals. Another practice frowned upon is making prior arrangements with a station for a QRP contact. It is also considered unethical to have a friend ask the desired station to "stand by for W6BLANK using QRP." I tried a few of these tactics during my early days of QRP operating before I learned how to behave. True, I made some contacts, but they didn't seem as rewarding as those made according to the rules.

I've heard some operators say that it isn't very productive for a QRP station to call CQ. This may be true during the early evening hours when the bands are crowded; however, I've found that if I get on the air late at night, find a clear spot, and call "QRP" several times followed by my callsign, it is possible to obtain replies. Furthermore, many foreign stations enjoy working U.S. QRP stations, as I have discovered on 40 meters, especially near 7025 and 7060 kHz. Overseas operators also do a lot of listening, and I was surprised one evening to find that stations were actually calling me after I finished a QSO with a Belgian station. What an experience! I'd actually created a mini pile-up.

It doesn't take much equipment to get a QRP station on the air. A simple but stable VFO will serve as a transmitter. A selective receiver is important, and the antenna should be as efficient as you can possibly make it. Although a gain antenna is an asset, a simple, well-matched dipole will give good results in QRP work.

If you want to experience a real sense of achievement resulting from some rigid operating discipline, I highly recommend QRP work. Now, I wonder who will be the first U.S. ham to earn the Worked All Continents award with 500 milliwatts on the new WARC bands?

Alf Wilson, W6NIF
editor

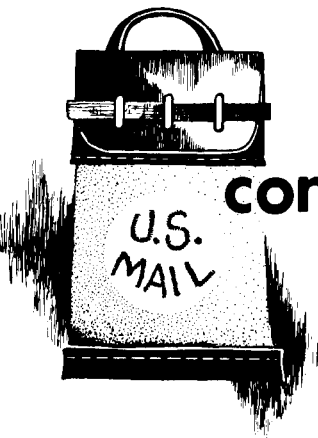

comments

Pendergast's return

Dear HR:

The article on traps in the October issue is excellent stuff. Very seldom do I get so interested in the first article that I get stuck there to the temporary exclusion of the rest of the magazine. I normally scan the whole issue first and start with the one that interests me most. The return of the magazine to an emphasis on technical excellence is most encouraging. Congratulations on a good job.

A couple of small points. In the July issue, page 52, 0.707 of the power has somehow become half the power; 0.707 of the field strength *in volts* would be half the power.

In the August issue I couldn't help a feeling of foreboding that Pendergast had snuck back into Bill Orr's material, and sure enough when I arrived at work there was a note from a colleague saying, "If you are writing to *ham radio* for Pete's sake complain about Pendergast's return." I am hereby passing on that message, with a fervent plea from me that Pendergast stay dead. Bill Orr is often interesting, but the dialogue sometimes gets in the way. I know many readers that feel this way, and can honestly say that I don't know anyone who likes Pendergast. It was most encouraging to see no mention of P. in October!

To come back to the Gary O'Neil piece on traps, I think it would interest all readers if you could print a note from Gary on the kind of power his RG8/U traps can handle, and how far off frequency you can operate before

the trap heats up because of circulating current. And here is a question. When feeding a trap dipole directly with coax (no balun), I find the trap in the side connected to the braid gets hot enough to melt the encapsulant, while the other one stays cool. Why? (Swapping them confirms that it is the position, not the trap, which causes the heating.)

Bob Eldridge, VE7BS
Pemberton, B. C.

lifeline SAR

Dear HR:

We are a volunteer, non-profit public service organization headquartered in Madison, Indiana, and we're looking for members from all over the world. Our prime objective is to form local chapter units for those areas that don't already have a qualified search and rescue (SAR) organization. There are, unfortunately, all too many such areas.

Our organization currently possesses members in 27 divisions (25 states plus Canada and the Republic of Singapore). We rely on Amateur Radio as a back-up communications network and for any long-range traffic we may have. Our primary means of communications is our own VHF-fm commercial radio system.

In addition to looking for members, we are also looking for donations of radio equipment (both VHF-fm commercial and Amateur) to help us build our organization and its chapters up to an operational level. All donations (cash and otherwise) are 100 percent deductible for federal income tax purposes.

Everyone is eligible to apply for membership. Those who inquire are asked to enclose an SASE to help with the rising costs of mailing. All inquiries will be answered promptly. For further information, please write Lifeline Search and Rescue, P.O. Box 237, Milton, Kentucky 40045.

Jeff E. Howell, CEMT (WB9PFZ)
Executive Director
Lifeline SAR

a card from Frenchy

Dear HR:

Bill Orr's article in the August issue brought back fond memories of DX for a then-young Amateur. After I got my ticket in mid 1938, it took me almost a year to scrounge up the parts for my homemade superhet and 6A6-PP6L6 transmitter.

By that time World War II had drawn the curtain over much of the DX, but nevertheless, my spare and weekend hours were spent listening for something "rare."

One early morning in December of 1939, there was the same KF6ROV mentioned in Bill's article, calling CQ; with trembling hand I called him, and "Frenchy" Paquette in Pago Pago came back to my call. This is one of my most prized QSLs.

Thanks again to Bill and to you for a fine magazine.

F.V. Sprick, W2LPV
Clifton, New Jersey

kilo foxtrot Charlie?

Dear HR:

In regard to the comments by Mr. H.B. Mouatt, W6BQD, in the January, 1982, issue, I am in full agreement. The use of Q signals on phone has long been a source of improper operation, insofar as they are intended for use on CW. If one is going to stop transmitting, simply say so, not QRT. I am sure there are others, but this is one I hear a lot. This practice seems to be common among newcomers and old-timers as well.

The use of one's own phonetics for one's own call, however, seems to be perfectly proper to me. I have heard both U.S. and foreign Amateurs use their own personal phonetics many times. In fact, one very good friend, Vic Clark, W4KFC (past ARRL VP and Roanoke Division Director), would probably be unrecognizable to me on the air if he were to say Whiskey Four Kilo Foxtrot Charlie instead of W4 Kentucky Fried Chicken.

Ed Redington, Jr., N4AGS
Ashland, Virginia

MFJ Super Keyboards



5 MODES: CW, Baudot, ASCII, memory keyer, Morse code practice. **TWO MODELS:** MFJ-496, \$339.95. 256 character buffer, 256 character message memory, automatic messages, serial numbering, repeat/delay. MFJ-494, \$279.95. 50 character buffer, 30 character memory, automatic messages.

MFJ brings you a pair of 5 Mode Super Keyboards that gives you more features per dollar than any other keyboard available. You can send CW, Baudot, ASCII. Use it as a memory keyer and for MORSE code practice.

You get text buffer, programmable and automatic message memories, error deletion, buffer preload, buffer hold, plus much more.

MODE 1: CW

The 256 character (50 for 494) text buffer makes sending perfect CW effortless even if you "hunt and peck."

You can preload a message into the buffer and transmit when ready. For break-in, you can stop the buffer, send comments on key paddles and then resume sending the buffer content.

Delete errors by backspacing.

A meter gives buffer remaining or speed. Two characters before buffer full the meter lights up red and the sidetone changes pitch.

Four programmable message memories (2 for 494) give a total of 256 characters (30 for 494). Each message starts after one ends for no wasted memory. Delete errors by backspacing.

To use the automatic messages, type your call into message A. Then by pressing the CQ button you send CQ CQ DE (message A).

The other automatic messages work the same way: CQ TEST DE, DE, QRZ.

Special keys for KN, SK, BT, AS, AA and AR. A lot of thought has gone into human engineering these MFJ Super Keyboards.

For example, you press only a one or two key sequence to execute any command.

All controls and keys are positioned logically and labeled clearly for instant recognition.

Pots are used for speed, volume, tone, and

weight because they are more human oriented than keystroke sequences and they remember your settings when power is off.

Weight control makes your signal distinctive to penetrate QRM.

MODE 2 & 3 (RTTY): BAUDOT & ASCII

5 level Baudot is transmitted at 60 WPM. Both RTTY and CW ID are provided.

Carriage return, line feed, and "LTRS" are sent automatically on the first space after 63 characters on a line. This gives unbroken words at the receiving end and frees you from sending the carriage return. After 70 characters the function is initiated without a space.

All up and down shift is done automatically. A downshift occurs on every space to quickly clear garbled reception.

The buffer, programmable and automatic messages, backspace delete and PTT control (keys your rig) are included.

The ASCII mode includes all the features of Baudot. Transmission speed is 110 baud. Both upper and lower case are generated.

MODE 4: MEMORY KEYSER

Plug in a paddle to use it as a deluxe full feature memory keyer with automatic and programmable memories, iambic operation, dot-dash memories, and all the features of the CW mode.

MODE 5: MORSE CODE PRACTICE

There are two Morse code practice modes. Mode 1: random length groups of random characters. Mode 2: pseudo random 5 character groups in 8 separate repeatable lists (with answers).

Insert space between characters and groups to form high speed characters at slower speed for easy character recognition.

Select alphabetic or alphanumeric plus punctuation. You can even pause and then resume.

MORE FEATURES

Automatic incrementing serial number from 0 to 999 can be inserted into buffer or message memory for contests.

Repeat function allows repetition of any message memory with 1 to 99 seconds delay. Lets you call CQ and repeat until answered.

Two key lockout operation prevents lost characters during typing speed bursts.

Clock option (496 only) send time in CW, Baudot, ASCII. 24 hour format.

Set CW sending speed before or while sending. **Tune switch with LED keys transmitter** for tuning. Tune key provides continuous dots to save finals. Built-in sidetone and speaker.

PTT (push-to-talk) output keys transmitter for Baudot and ASCII modes.

Reliable solid state keying for CW: grid block, cathode, solid state transmitters (-300V, 10 ma Max, +300V, 100 ma Max). TTL and open collector outputs for RTTY and ASCII.

Fully shielded. RF proof. All aluminum cabinet. Black bottom, eggshell white top. 12"Dx7"Wx1 1/4"H (front) x3 1/2"H (back). Red LED indicates on.

9-12 VDC or 110 VAC with optional adapter.

MFJ-494 is like MFJ-496 less sequential numbering, repeat/delay functions. Has 50 character buffer, 30 character message memory. Clock option not available for MFJ-494.

Every single unit is tested for performance and inspected for quality. Solid American construction.

OPTIONS

MFJ-53 AFSK PLUG-IN MODULE. 170 and 850 Hz shift. Output plugs into mic or phone patch jack for FSK with SSB rigs and AFSK with FM or AM rigs. \$39.95 (+ \$3).

MFJ-54 LOOP KEYING PLUG-IN MODULE. 300V, 60 ma loop keying circuit drives your RTTY printer. Opto-isolated. TTL input for your computer to drive your printer. \$29.95 (+ \$3).

MFJ-61 CLOCK MODULE (MFJ-496 only). Press key to send time in CW, Baudot or ASCII. 24 hour format. \$29.95 (+ \$3).

110 VAC ADAPTER. \$7.95 (+ \$3).

BENCHER IAMBIC PADDLE. \$42.95 (+ \$4).

A PERSONAL TEST

Give the MFJ-496 or MFJ-494 Super Keyboard a personal test right in your own ham shack.

Order one from MFJ and try it — no obligation. See how easy it is to operate and how much more enjoyable CW and RTTY can be. If not delighted, return it within 30 days for refund (less shipping). One year unconditional guarantee.

To order, call toll free 800-647-1800. Charge VISA, MC, or mail check or money order for \$339.95 for MFJ-496, \$279.95 for MFJ-494, \$39.95 for MFJ-53 AFSK module, \$29.95 for MFJ-54 Loop Keying module, \$29.95 for MFJ-61 Clock module, \$7.95 for the 110 VAC adapter and \$42.95 for Bencher Paddle. Include \$5.00 shipping and handling per order or as indicated in parentheses if items are ordered separately.

Why not really enjoy CW and RTTY? Order your MFJ Super Keyboard at no obligation today.

**TO ORDER OR FOR YOUR NEAREST DEALER
CALL TOLL FREE 800-647-1800**

Call 601-323-5869 for technical information, order/repair status. Also call 601-323-5869 outside continental USA and in Mississippi.

Write for FREE catalog, over 80 products

**MFJ ENTERPRISES,
INCORPORATED**

Box 494, Mississippi State, MS 39762



THE FCC HAS ACTED IN THE JAMMING cases involving the Maritime Mobile Services Net. In a release dated January 28, 1982, the Commission revoked the license of Leonard M. Boucher, K4MME, of Cantonment, Florida, and at the same time suspended for one year the license of Gerard Morin, W1GM, of Sanford, Maine. In their "Order of Revocation and Suspension" the Commission found that, between August, 1980, and June, 1981, Boucher and Morin operated in a split frequency scheme designed to deliberately and maliciously interfere with radio nets operating on the frequency of 14.313 MHz.

Boucher Received The Greatest Amount Of Attention and criticism from the FCC. They noted that on February 17, 1981, they monitored Boucher requesting a station to move down with him to the frequency on which net participants were operating, and on February 18th he was again heard to criticize the operator of a station for not moving directly on top of the frequency occupied by the net. Other instances were cited as well.

A5 MAGAZINE HAS PROPOSED SSTV operating frequencies based on the recent approval of FCC Docket 80-252 which expands SSTV/FAX operations in the General Class phone bands. A5 proposes the following frequencies: 3.990, 7.290, 14.340, and 21.440 MHz with all movement upward only utilizing the top 10 kHz of band edges. Any comments should go to Mike Stone, WB0QCD, A5 Magazine, P.O. Box H, Lowden, Iowa 52255. Mike will also be on hand at the 1982 Dayton Hamvention's ATV Forum at 2:00 PM on Saturday, April 24th.

ARNIE VERDOW, W0LIJ, a familiar sight at many hamfests as he manned the Collins booth, passed away February 1. His easy going, likable manner, along with his extensive first-hand knowledge of post-war Collins products, combined to make him a favorite in the Amateur community. He will be missed as a professional but even more as a good friend.

THE UNITED STATES WILL SOON HAVE A "WOODPECKER" operating in the 5 to 35 MHz spectrum. Like its Russian counterpart, it also will be an over-the-horizon radar system. It will be located near the city of Moscow, Maine. Built by General Electric Corporation under contract to the U.S. Air Force, it will have an ERP of 1.2 megawatts. The system is in its final testing stage, with full-time operation scheduled to begin sometime in 1982. What effect our woodpecker will have on Amateur Radio hf communications is unknown, but the military has promised to work with the Amateur community to reduce its impact.

DR. NORM CHALFIN, K6PGX, REPORTS that Wednesdays (UTC) are Experimental Days on the Soviet R/S Satellites. During that time, the birds are reserved for previously arranged uplink transmissions. Chalfin also informs us that all passbands on the R/S transponders are linear; that is, USB in on 2 meters produces USB out on 10.

SATELLITE TELECASTERS ARE GOING TO GREAT LENGTHS to try to end the pirating of their subscription services. Premier Communications Network of San Jose, California, placed an advertisement in a recent edition of the San Jose Mercury newspaper appealing to area residents to trade in their "illegal" pirate antennas on a "legal" installation from their company for Home Box Office service. The newspaper ad contains a reprint of findings regarding the secrecy of communications provisions of Section 605 of the Communications Act, and it then offers amnesty along with guaranteed service to anyone answering the ad and becoming a subscriber.

Swift Reaction Has Come From The Area's Local Amateurs. Writing in the Bay Area 220 Group newsletter, Pres. Jerry Lahtinen, W6TTU, stated that his organization considers HBO to be the real pirates since that service utilizes publicly owned spectrum, and he has called for the abolition of HBO entirely.

AN ON-SITE ALERT AT THE R. E. GINNA NUCLEAR PLANT January 25th saw hams from Rochester, Monroe County, and Wayne County (New York) put themselves on alert as well. Fortunately, the problem did not require evacuation of the area and the alert was downgraded just a few hours later. Ironically, this "real alert" followed only four days after a mock Nuclear Evacuation Drill had been held in the same area.

RE-BALLOTING IN TWO DISPUTED ARRL DIRECTOR'S ELECTIONS show that the incumbents, William Stevens, W6ZM, (Pacific Division), and Leonard Nathanson, W8RC, (Great Lakes Division), have been re-elected. According to League headquarters, in each case the winner's margin was almost 2:1 over his opponent.

ON JANUARY 4TH THE FCC BEGAN ISSUING the new General Radiotelephone license to replace the 1st and 2nd class phone licenses that were discontinued last year. The order initiating the change came last August but could not be implemented until new license forms had been printed. Current holders of 1st or 2nd class tickets should note that they are valid until expiration, but when renewed they will become General Radiotelephone licenses. All new licenses will be of that class as well.

The right design — for all the right reasons. In setting forth design parameters for ARGOSY, Ten-Tec engineers pursued the goal of giving amateurs a rig with the right features at a price that stops the amateur radio price spiral.

The result is a unique new transmitter with selectable power levels (convertible from 10 watts to 100 watts at the flick of a switch), a rig with the right bands (80 through 10 meters including the new 30 meter band), a rig with the right operational features plus the right options, and the right price for today's economy—just \$549.

Low power or high power, ARGOSY has it. Now you can enjoy the sport and challenge of QRPp operating, and, when you need it, the power to stand up to the crowds in QRM and poor band conditions. Just flip a switch to move from true QRPp power with the correct bias voltages to a full 100 watt input.

New analog readout design. Fast, easy, reliable, and efficient. The modern new readout on the ARGOSY is a mechanical design that instantly gives you all significant figures of any frequency. Right down to five figures (± 2 kHz). The band switch indicates the first two figures (MHz), the linear scale with lighted red bar-pointer indicates the third figure (hundreds) and the tuning knob skirt gives you the fourth and fifth figures (tens and units). Easy. And efficient—so battery operation is easily achieved.

The right receiver features. Sensitivity of 0.3 μ V for 10 dB S+N/N. **Selectivity:** the standard 4-pole crystal filter has 2.5 kHz bandwidth and a 2.7:1 shape factor at 6/50 dB.

Other cw and ssb filters are available as options, see below. I-f frequency is 9 MHz, i-f rejection 60 dB. **Offset tuning** is ± 3 kHz with a detent zero position in the center. **Built-in notch filter** has a better than 50 dB rejection notch, tunable from 200 Hz to 3.5 kHz. An optional noise blanker of

utes on all bands. **3-function meter** shows forward peak power on transmit, SWR, and received signal strength. **PTT** on ssb, **full break-in** on cw. PIN diode antenna switch. **Built-in cw sidetone** with variable pitch and volume. **ALC control** on "high" power only where needed, with LED indicator.

Automatic normal sideband selection plus reverse. **Normal 12-14V dc** operation plus ac operation with optional power supply.

The right styling, the right size. Easy-to-use controls, fast-action push buttons, all located on raised front panel sections. New meter with lighted, easy-to-read scales. Rigid steel chassis, molded front panel with matching aluminum top, bottom and back.

Stainless steel tilt-up bail. And it's only 4" high by 9½" wide by 12" deep (bail not extended) to go anywhere, fit anywhere at home, in the field, car, plane or boat.

The right accessories—all front-panel switchable.

Model 220 2.4 kHz 8-pole ssb filter \$55; Model 218 1.8 kHz 8 pole ssb filter \$55; Model 225 117/230V ac power supply \$129; Model 222 mobile mount, \$25; Model 1126 linear switching kit, \$15.

Model 224 Audio cw filter \$34; Model 223 Noise blanker \$34; Model 226 internal Calibrator \$39; Model 1125 Dc circuit breaker \$15; Model 225 117/230V ac power supply \$129; Model 222 mobile mount, \$25; Model 1126 linear switching kit, \$15.

Model 525 ARGOSY — \$549. Make the right choice, ARGOSY—for the right reasons and low price. See your TEN-TEC dealer or write.

TEN-TEC, INC.
SEVIERVILLE, TENNESSEE 37862

Here's a Concept You Haven't Seen In Amateur Radio For A Long Time—Low Price.



New TEN-TEC Argosy \$549

the i-f type has 50 dB blanking range. **Built-in speaker** is powered by low-distortion audio (less than 2% THD)

The right transmitter features. Frequency coverage from 80 through 10 meters, including the new 30 meter band, in nine 500 kHz segments (four segments for 10 meters), with approximately 40 kHz VFO overrun on each band edge. **Convertible power:** 100 or 10 watts input with 100% duty cycle for up to 20 min-

stripline kilowatt amplifier for 220 MHz

Updated version of
a design published
previously in *ham radio*



Front and rear views of the 220-MHz stripline kilowatt amplifier, which is enclosed in two mated chassis. Two optional designs are available, one for triode and one for tetrode tubes.

The 144-MHz stripline kilowatt amplifier described in the October, 1977, issue of *ham radio*¹ has been constructed and operated by a number of Amateurs, both from the information in the article and from parts kits available from ARCOS.* A 220-MHz version of this amplifier was built and tested during 1977 and has been reproduced several times. One of these models has been in service on a 220-MHz repeater for over two years. This same amplifier was borrowed from the repeater and used during VHF/UHF tests over the past two years by the W2SZ/1 (Mount

*ARCOS, Amateur Radio Component Service, Box 546, East Greenbush, New York 12061. All parts for the 220 amplifier and power supply are available.

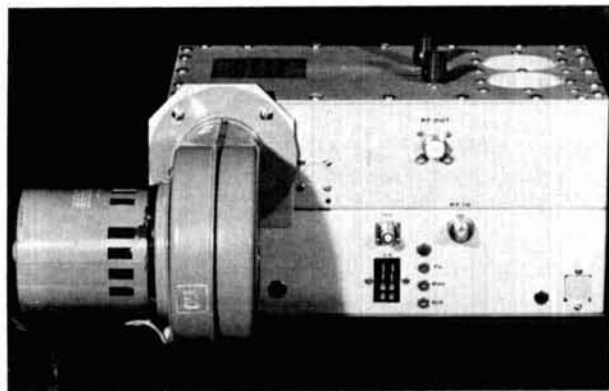

By F. J. Merry, W2GN, 35 Highland Drive, East Greenbush, New York 12061

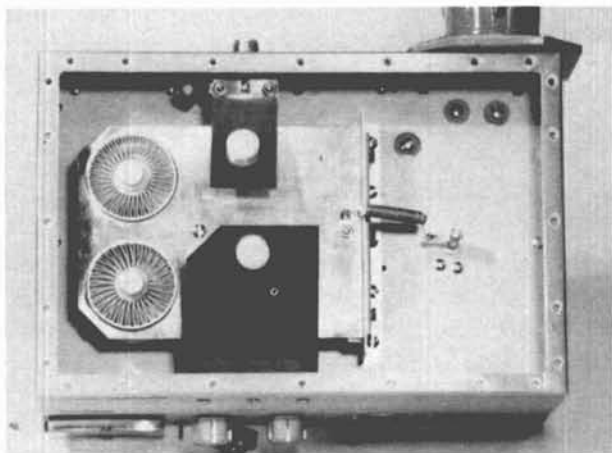

Top view of the stripline amplifier with cover removed showing the load and tuning flappers.

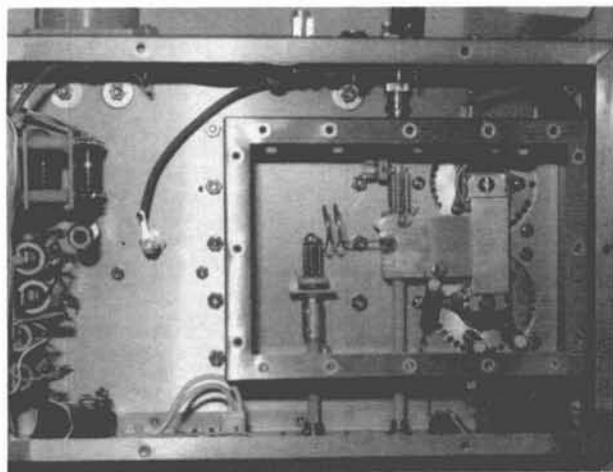

Bottom view of the triode amplifier with cover removed.

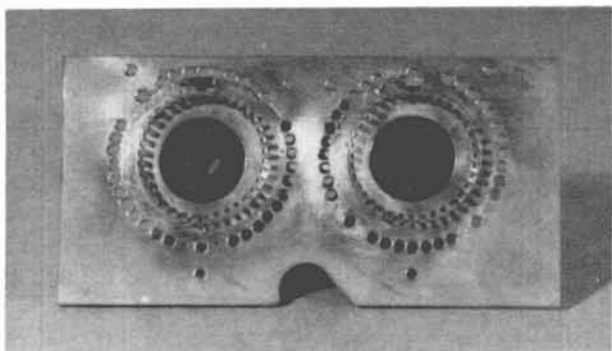

Socket assembly for the 8874 triodes, which may be installed onto the amplifier chassis in place of the tetrode sockets.

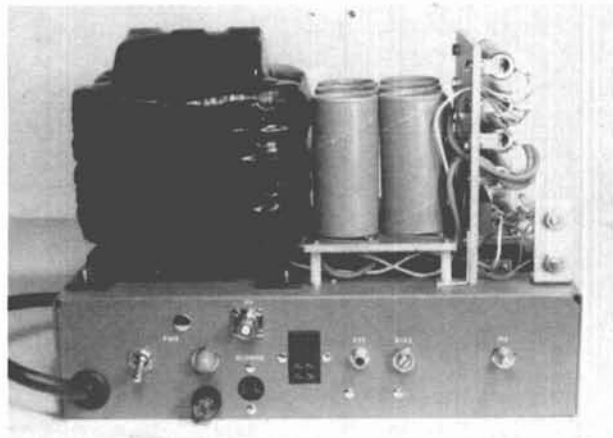

Front view of the power supply with cover removed.

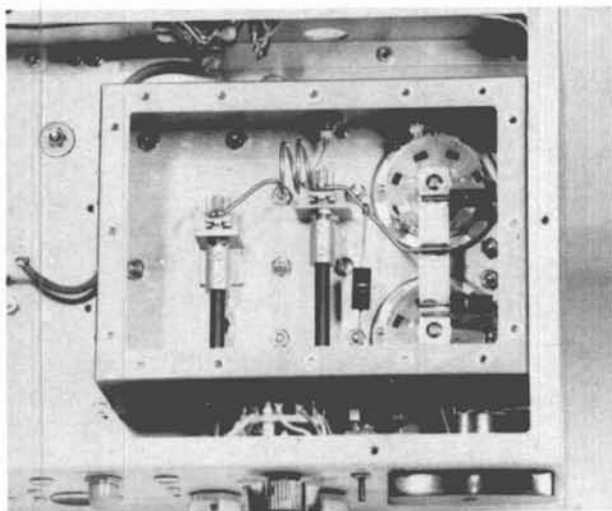

Bottom view of the tetrode amplifier with cover removed.



Front view of the power supply for the stripline amplifier with cover installed.

Greylock) group. Experience has been favorable in all respects.

The experienced builder, especially if he has built the 144-MHz model, will find no difficulty in building and operating the 220-MHz version. With EME and tropo activity on 220 MHz on the increase, this amplifier is a good candidate where there is a need for reliable high-power operation.

Similar to the 144-MHz amplifier in chassis dimensions and other respects, the 220-MHz version uses a quarter-wave plate line and a coil-simulated half-wave grid line. Except for the plate-line mounting screws, the location of the high-voltage feedthrough capacitor and a hole for a bushing for the plate tuning flapper drive string, chassis punching is identical to the drawings for the 144-MHz amplifier as described in reference 1. Originally described by K2R1W (reference 2) for a 432-MHz stripline amplifier, this type of chassis construction has proven adaptable to not only 432, 220, and 144 MHz but also to an equally successful 50-MHz version using a pi-network output circuit with inductive tuning. The 50-MHz model will be described in a subsequent article.

The amplifiers mentioned above can use any of the ceramic tetrodes such as the 4CX250R, 4CX250B, or 8930, further illustrating the flexibility of this type of chassis construction. The 8874 triodes can also be

used in a grounded-grid application by installing a mounting plate for the 8874 sockets in place of the individual EIMAC 630A sockets. The triode amplifiers have the advantage of not requiring the critical screen supply voltage and the disadvantages of higher tube cost and higher drive power requirement.

design

Referring to the schematic, (fig. 1), the quarter-wave plate line is tuned and loaded by flapper capacitors. The plate blocking capacitor is a Teflon sandwich at the cold (rf) end of the line. The grids are connected by a strap to which is connected the grid coil. A 1k, 2-watt resistor is used for a grid choke (class AB1 operation — no grid current). A 1k, 2-watt resistor in series with a 1000-pF capacitor is connected to ground from each grid. These two loading resistors increase the stability margin of the amplifier and desensitize it so that it can be driven to 500 watts output with about 10 watts of drive. Additional resistors may be added depending on the drive power available. If the grid load resistors are omitted, the amplifier is stable but it becomes extremely power sensitive.

A further examination of the schematic reveals an optional rf output indicator circuit and 660-MHz and

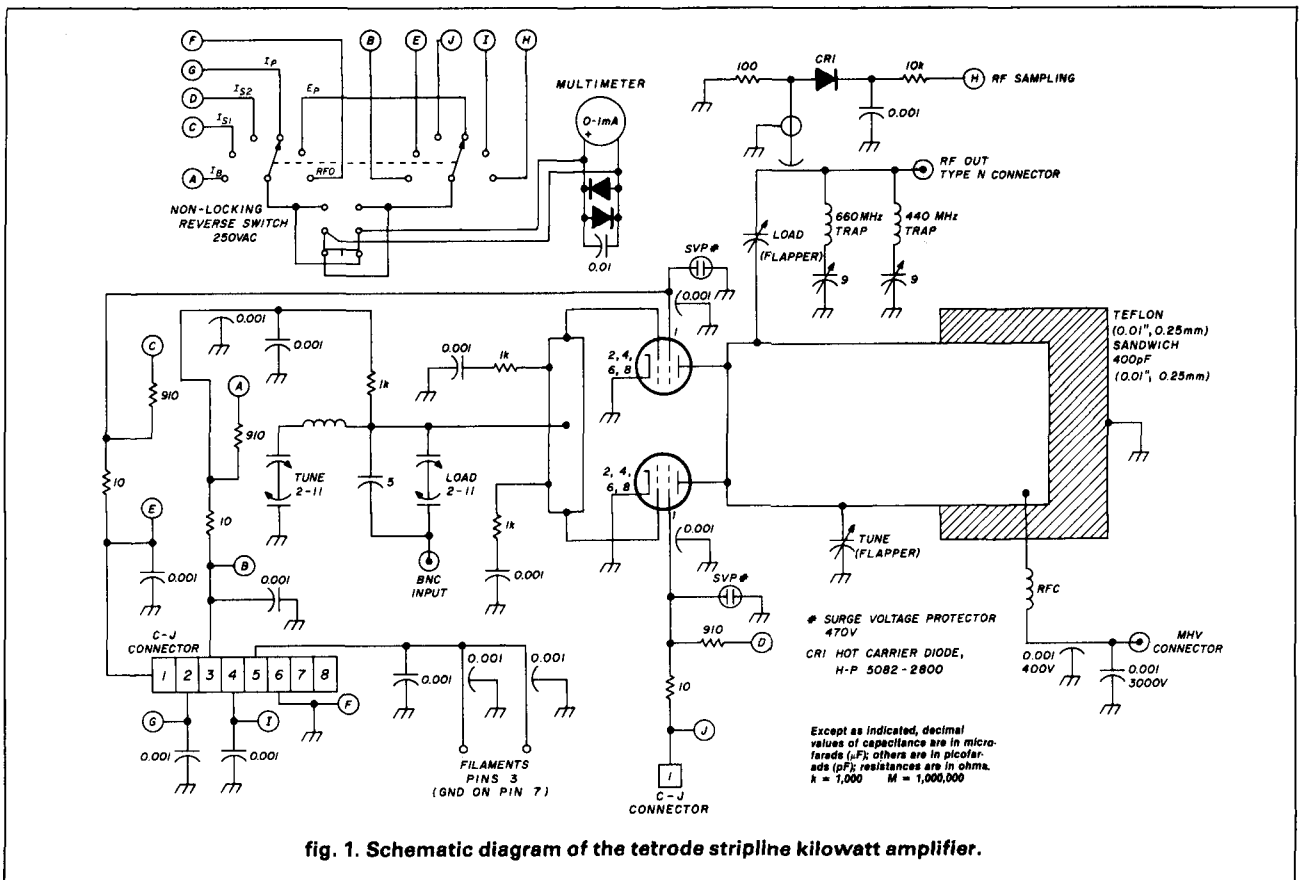

fig. 1. Schematic diagram of the tetrode stripline kilowatt amplifier.

440-MHz harmonic traps in the rf output, surge voltage protectors (SVPs) on the screen leads, and the usual lead filtering to keep the rf locked into the grid box and plate compartment. Metering is with a single 0-1 mA meter and a six-position switch with appropriate metering resistors for plate current, plate voltage, individual screen currents, grid current, and relative rf output. Thus, all important operating parameters are monitored.

A nonlocking reversing switch facilitates reading negative values of screen and grid currents, which are normally experienced with tetrode amplifiers. I recommend that an rf output wattmeter be used instead of the relative rf output indicator circuit. Proper adjustment of the plate tuning controls is difficult unless both plate current and the rf power output can be observed simultaneously. Other dc metering arrangements may, of course, be employed, including enclosing the meter circuit in a separate box at the operating position with the amplifier remotely located or by locating the metering circuit in the power-supply chassis.

The surge-voltage protectors in the screen circuit will ground the screens if the screen voltage rises above 470 volts. This protection is important and should be provided on all tetrode amplifiers. Emission effects in ceramic tetrodes will cause the screen to go negative under certain operating conditions. When this condition occurs, the screen voltage rises, causing higher plate current. The tubes can go into a runaway condition unless the amplifier is shut down. The surge voltage protectors prevent the runaway condition by automatically reducing the screen voltage to a very low value. Once one of the SVPs has fired, it's usually necessary to shut off the power. Power may be restored after a pause to let the capacitors discharge to a point below the sustaining voltage of the SVP that fired. A small saving can be realized by using only one SVP connected to the screen-supply lead.

Two other factors are involved in foolproof operation of the screen circuit:

1. The screen power supply must be provided with a current-limiting resistor so that the current doesn't exceed about 100 mA when one of the SVPs fires.
2. The power supply must have a resistor, from screens to negative, which is of a value low enough to provide a sink current of at least 40 mA. This feature provides a path for the negative screen current so that the screen voltage will hold at the regulated value.

With the above features provided in the screen circuit, the tetrode amplifier will perform as reliably and smoothly as a triode amplifier.

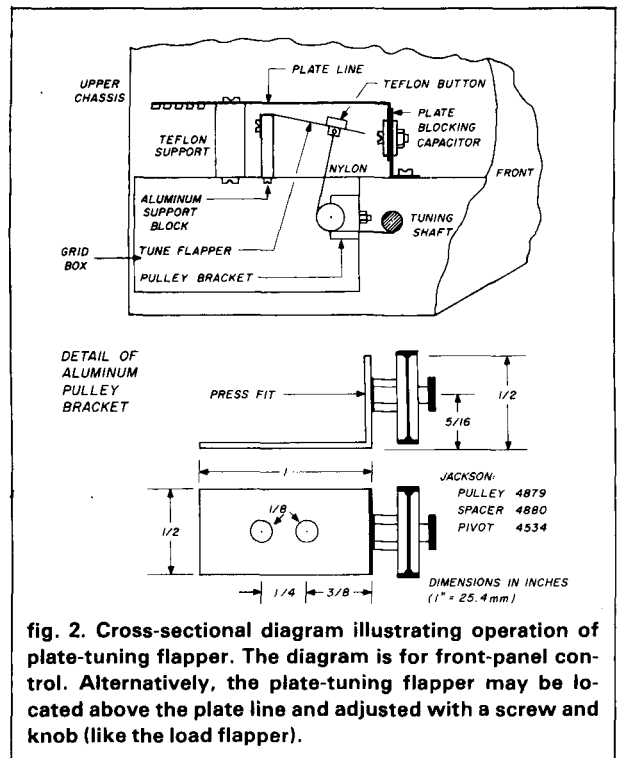

fig. 2. Cross-sectional diagram illustrating operation of plate-tuning flapper. The diagram is for front-panel control. Alternatively, the plate-tuning flapper may be located above the plate line and adjusted with a screw and knob (like the load flapper).

construction*

Chassis punching and drilling follows the same pattern shown by the drawings and as discussed in the 2-meter amplifier article.¹ Variations are listed below.

Plate-line mounting holes. The five holes in the right end (facing front) of the upper chassis (used to mount the 2-meter plate line) are not required. The 3/16 inch (5 mm) holes that fasten the 1-1/4 meter plate line to the chassis are located by setting the line in place with the tubes installed.

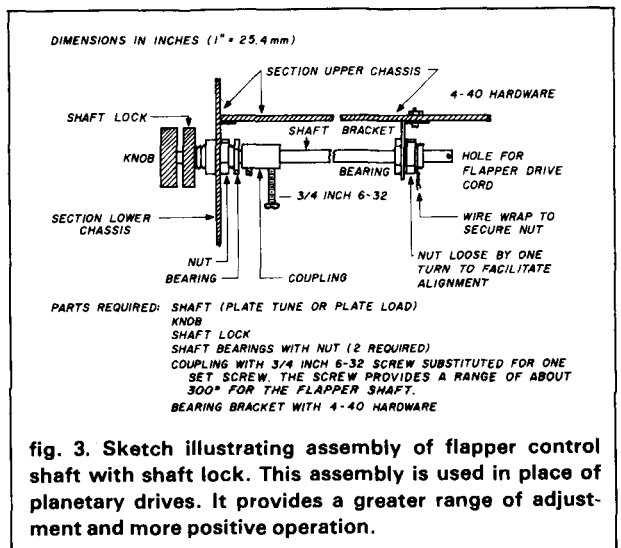

fig. 3. Sketch illustrating assembly of flapper control shaft with shaft lock. This assembly is used in place of planetary drives. It provides a greater range of adjustment and more positive operation.

*See the appendix before proceeding further.

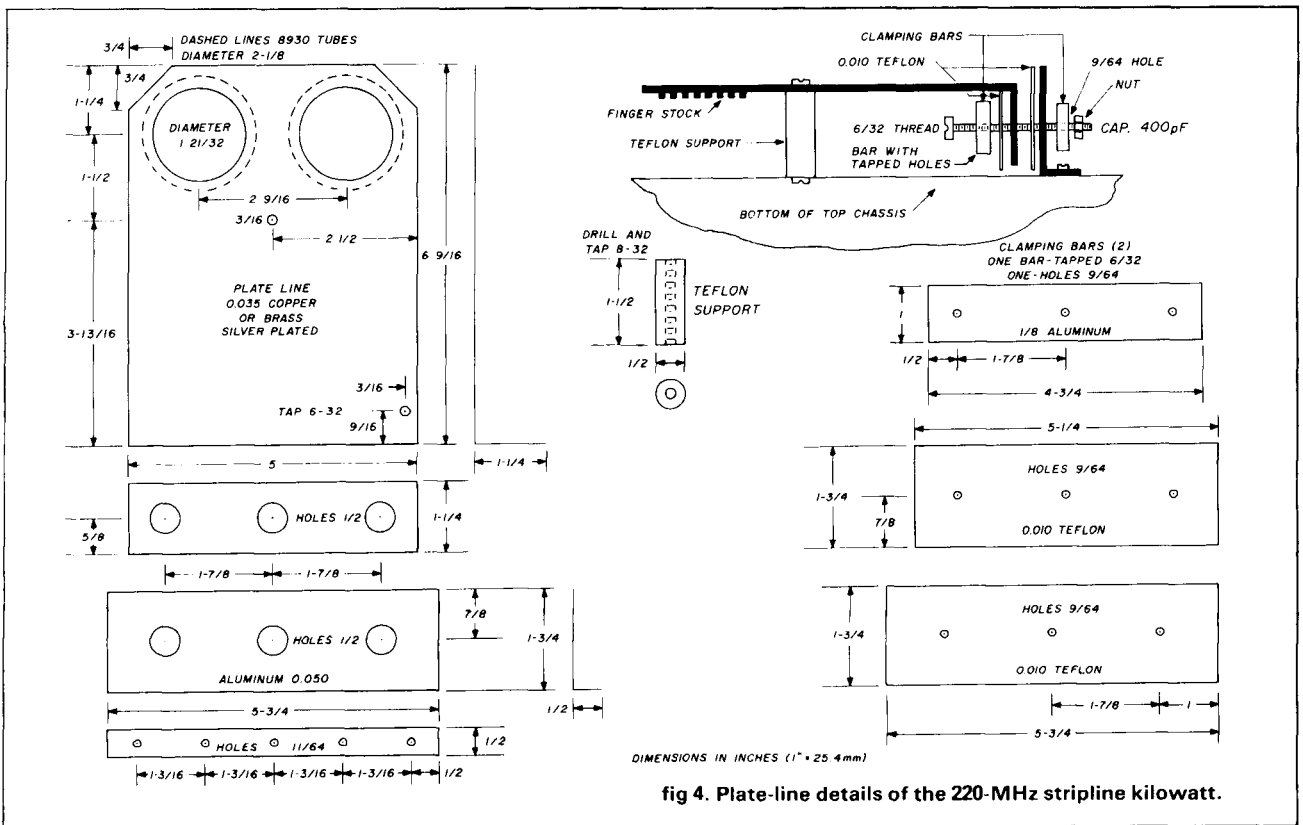

fig 4. Plate-line details of the 220-MHz stripline kilowatt.

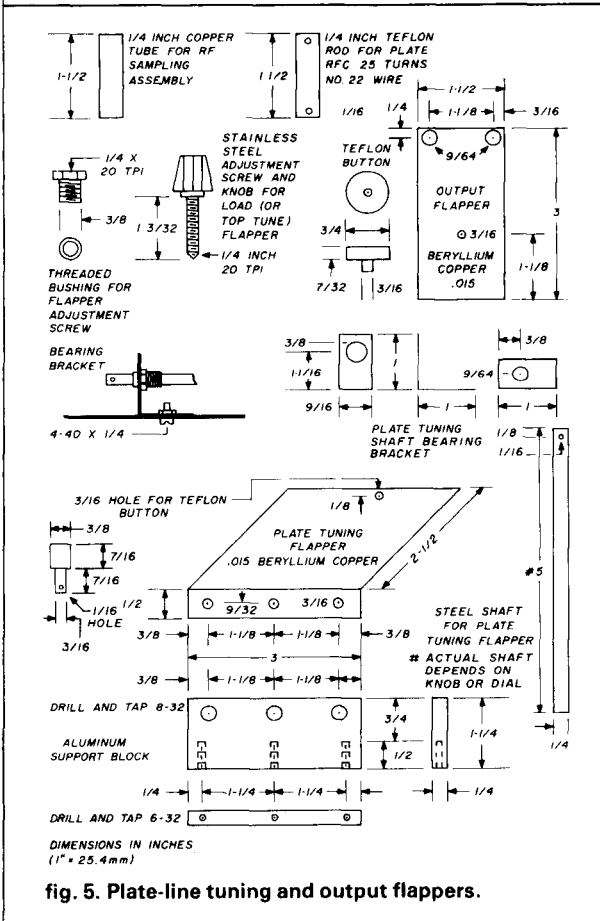

fig. 5. Plate-line tuning and output flappers.

Mounting the high-voltage feedthrough capacitor. The 7/16 inch (11 mm) hole for the high-voltage feedthrough capacitor is located 2 inches (5 cm) to the right (facing the front of the amplifier) of the cold end of the plate line and in line with the rear edge of the plate line. The rf choke is mounted between a lug on the plate line and another lug on the high-voltage feedthrough capacitor.

Plate-tuning flapper. The plate-tuning flapper is mounted on an aluminum block as in the 2-meter amplifier. It is shorter than the 2-meter flapper. The drive cord is connected to the tuning control through a pulley inside the grid box, fig. 2. A knob shaft lock and a steel shaft provide the plate tuning adjustment, fig. 3.

An alternative method of installing and controlling the plate tuning flapper is to secure it to the front of the upper chassis wall and adjust it with a 1/4 inch (6.4 mm) threaded rod from the top of the chassis — a simple and positive method of control, the same as that used to control the plate load flapper.

Plate line. The construction of the plate line is shown in figs. 4 and 5. The parts of the line must be free of burrs to avoid puncturing the Teflon insula-

tion. Assembly of the line must be accurate so that the screws holding the clamping bars are centered in the holes in the plate line and the underside of the plate line is 1-1/2 inches (38 mm) from the floor of the upper chassis.

Grid circuit. Details of the grid circuit are shown in fig. 6. Miniature capacitors (20-pF) may be substituted for the butterfly caps. The advantage of the costly butterfly cap is that no bearings are included in the rf path. The 2-11 pF butterfly caps will require a 10-pF padder mounted across the two stators.

triode amplifier

If the 8874 triodes are the tube choice, the sockets can be mounted on a brass plate, which is then installed onto the amplifier chassis in place of the EIMAC 630A sockets used for the tetrodes, fig. 7. There's no need to change dimensions of the plate line provided it's for the 4CX250 tubes. The grid line becomes the cathode line, and an rf choke is substituted for the 1k, 2-watt grid resistor. The grid load resistors are also omitted. See the schematic of the triode version, fig. 8.

Note that the triode amplifier has two meters mounted on the chassis. The right-hand meter reads plate current; the left-hand meter reads grid current. By operating a nonlocking meter switch, plate voltage is read on the grid-current meter. (I assume that an rf wattmeter will be used to monitor power output.)

Metering and cathode resistors are mounted on the right-hand end of the lower chassis. The zener bias diode and the control connector are mounted on the rear of the lower chassis. An ungrounded contact closure on the control connector is required to establish operating bias.

harmonic traps and rf indicator pickup

The harmonic traps (440 MHz and 660 MHz) in the rf output are installed in a small box (Pomona 2428) mounted on the rear of the amplifier, fig. 9. Alternatively, these traps can be installed in a box with coaxial connectors on each end (Pomona 2411). This box can be inserted in the output line at the rf output connector or immediately following the output wattmeter. The adjustment of these traps is best done

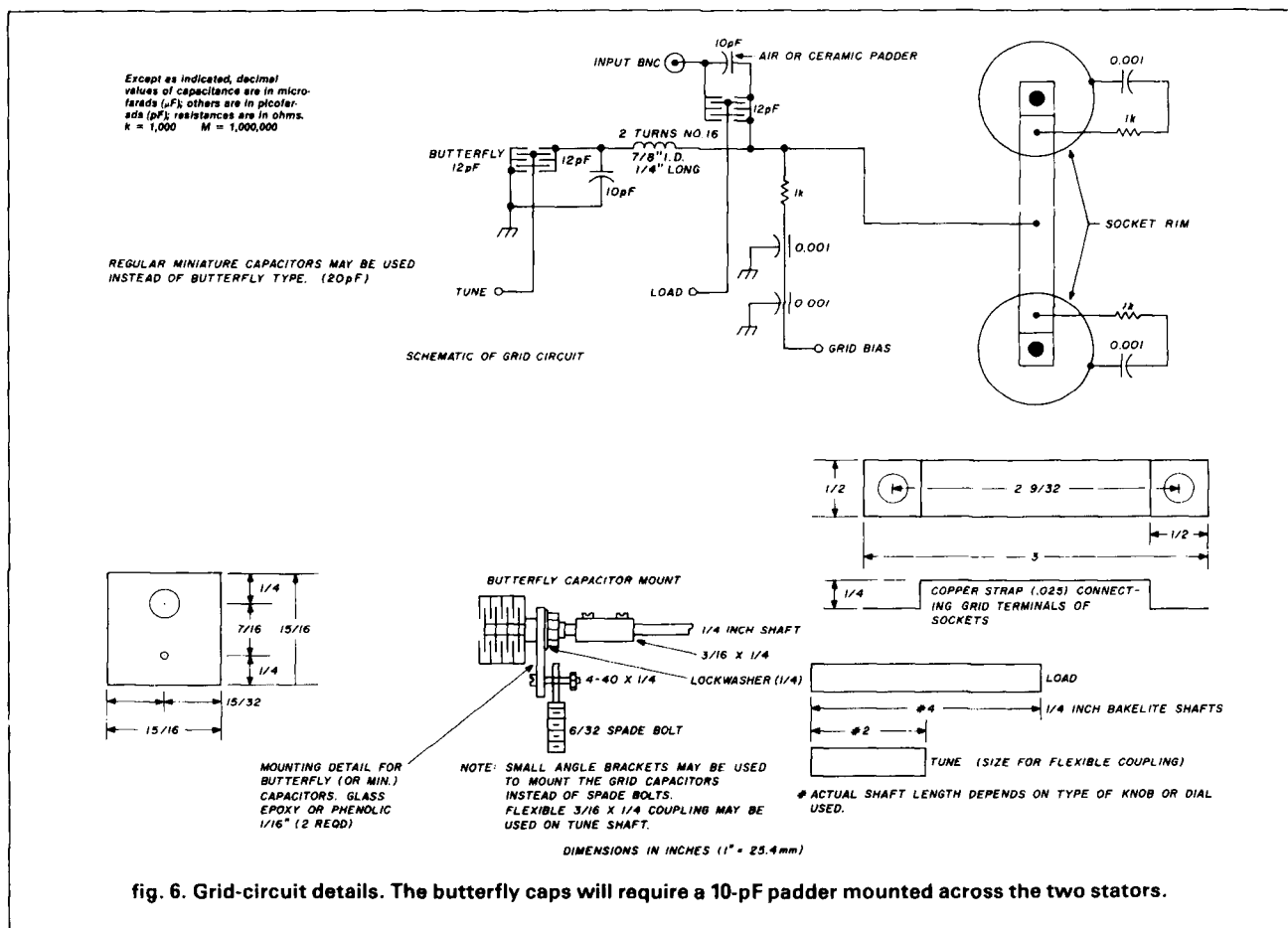

fig. 6. Grid-circuit details. The butterfly caps will require a 10-pF padder mounted across the two stators.

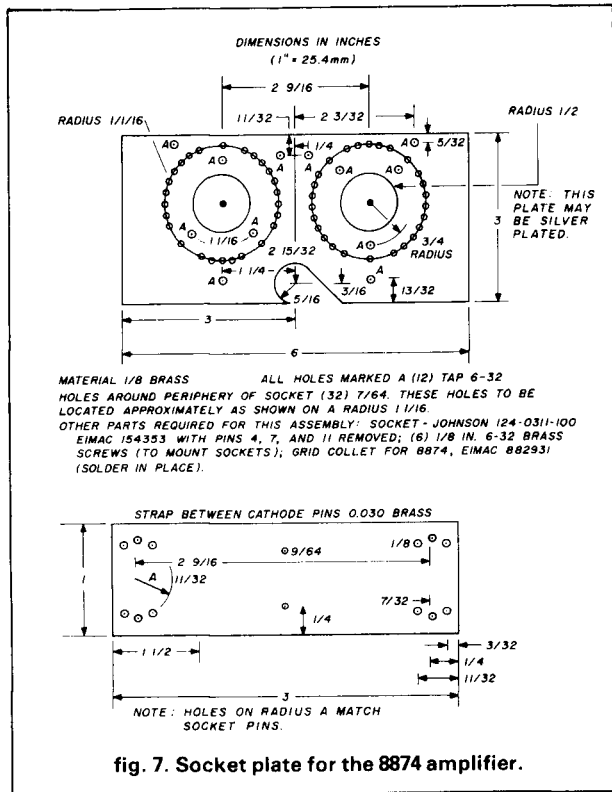

fig. 7. Socket plate for the 8874 amplifier.

while observing the level of the harmonic output on a spectrum analyzer.

The rf pickup assembly is also illustrated in fig. 9. The amount of rf pickup is obtained by adjusting the position of the lug, which is mounted on top of the output flapper, with respect to the lug on the stand-off insulator.

The rf pickup assembly may be omitted if you plan to have an rf wattmeter in the output circuit. As I mentioned previously, it's desirable to have an rf wattmeter to monitor output and to achieve the best adjustment of plate tune and load controls for maximum efficiency.

assembly

The following sequence is suggested for assembly:

1. Mount and wire all parts on the lower chassis.
2. Fasten the grid box to the upper chassis and install the sockets, feedthrough capacitors, SVPs and BNC input connector. For the tetrode amplifier, orient the sockets so that terminals 1 and 3 are opposite their respective feedthrough caps. The sockets for the triode amplifier are mounted so that the heater terminals are positioned between their respective feedthrough capacitors on the cathode box.

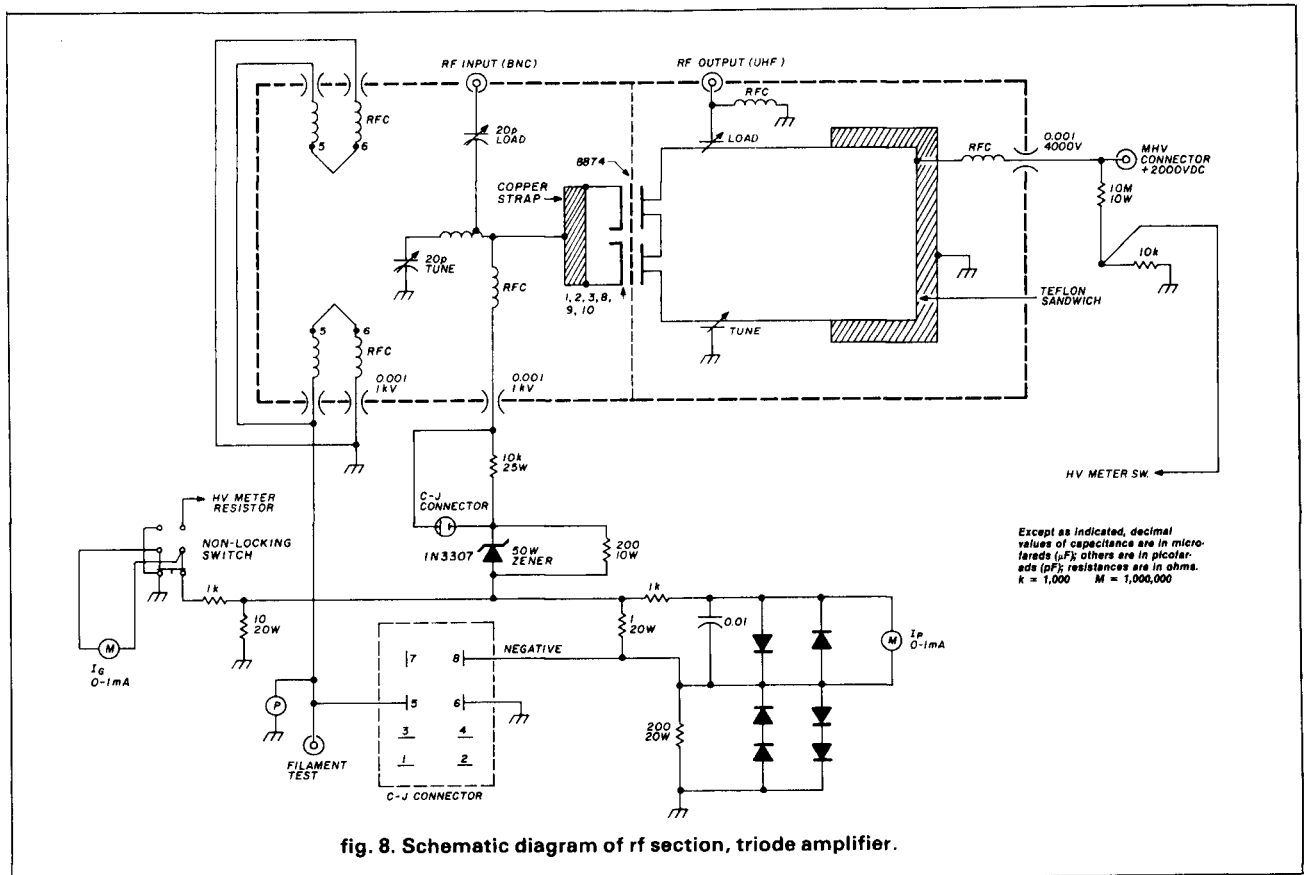

fig. 8. Schematic diagram of rf section, triode amplifier.

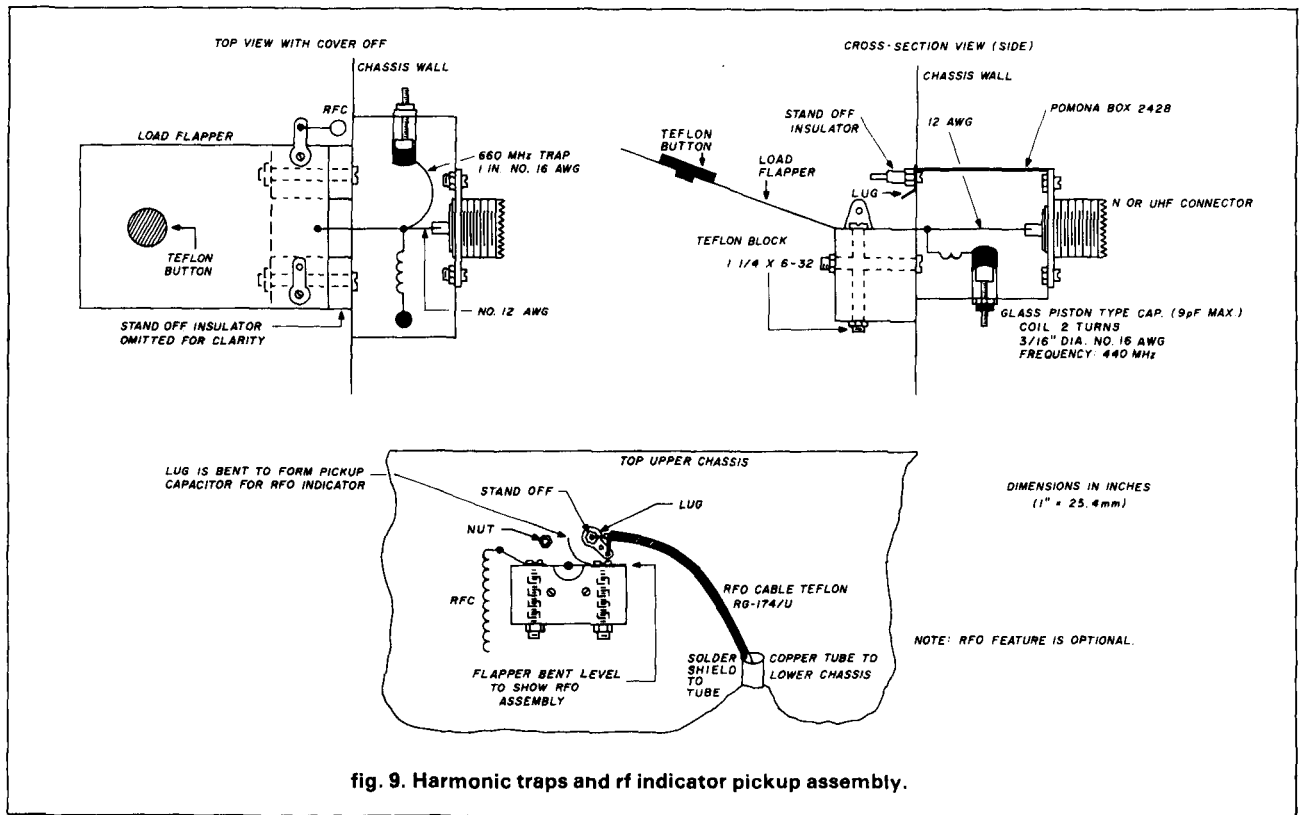

fig. 9. Harmonic traps and rf indicator pickup assembly.

3. Install the high-voltage feedthrough capacitor and the rf output pickup assembly.
4. Fasten the upper and lower chassis together and complete the wiring interconnections.
5. Mount the butterfly caps in the grid box (fig. 6) and install the tune and load controls.
6. Install the grid line, grid coil and resistors as in fig. 6.
7. Install the plate-tuning flapper, pulley, dial, shaft and bearing. Tie the nylon line to the flapper before mounting the flapper.
8. Install the tubes temporarily and put the plate line (previously assembled) in place. Work the finger stock over the tubes *very carefully*. Make sure everything lines up. Mark the mounting holes at the end of the plate line, then remove the plate line and tubes and drill the mounting holes for the plate line. Reinstall tubes and plate line.
9. Connect the plate rf choke.
10. Install the output flapper, rf grounding choke and RFO assembly.
11. Assemble the top plate screen and vent plate and the threaded bushing for flapper adjustment. Put the tubes in place and put the Teflon chimneys in posi-

tion in the vent plate. Fasten the top plate in place.

12. Recheck wiring and fasten the bottom plate.

The amplifier is now ready for test.

blower

The blower may be mounted onto the air-intake plate on the rear of the amplifier or it may be hose connected. The Dayton model 4C012A specified in the 2-meter construction article² is satisfactory for normal operation. Figs. 10 and 11 give the dimensions for air-intake plates for higher-power blowers;

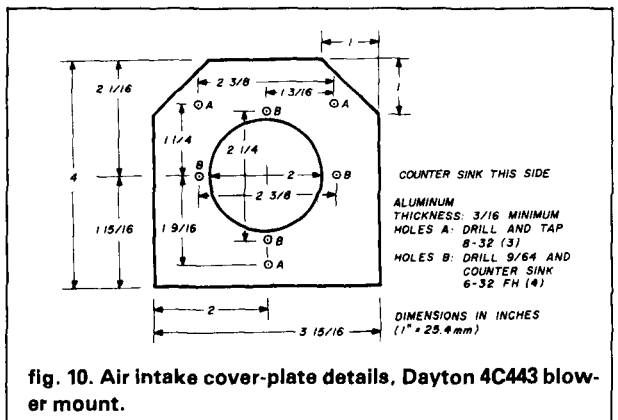

fig. 10. Air intake cover-plate details, Dayton 4C443 blower mount.

that is, the Dayton 4C443 (100 CFM) and the Rotron V537A2R4 (160 CFM). Generally speaking, the more air flow the better, so the choice of blowers is usually a compromise based on noise level and price. The noise can be reduced appreciably by control circuits that reduce blower speed during standby periods. To make the blower operation foolproof (the amplifier will fail in less than a minute without air), an air switch can be mounted in the output air stream of the blower, or a pressure switch can be mounted on the upper chassis. These switches can be connected to shut down the power supply or bias the amplifier to cutoff (see next section).

power supply

The power supply was given a rather brief treatment in the previous article.¹ There's a tendency to consider the power-supply design and construction as less significant than the amplifier. This can be a mistake, especially for the tetrode screen supply which, as discussed previously, has critical re-

quirements for successful operation of tetrodes. This time, to provide background on its operation, the power supply is described in some detail (see the schematic, fig. 12).

Features of modern high-voltage power supply

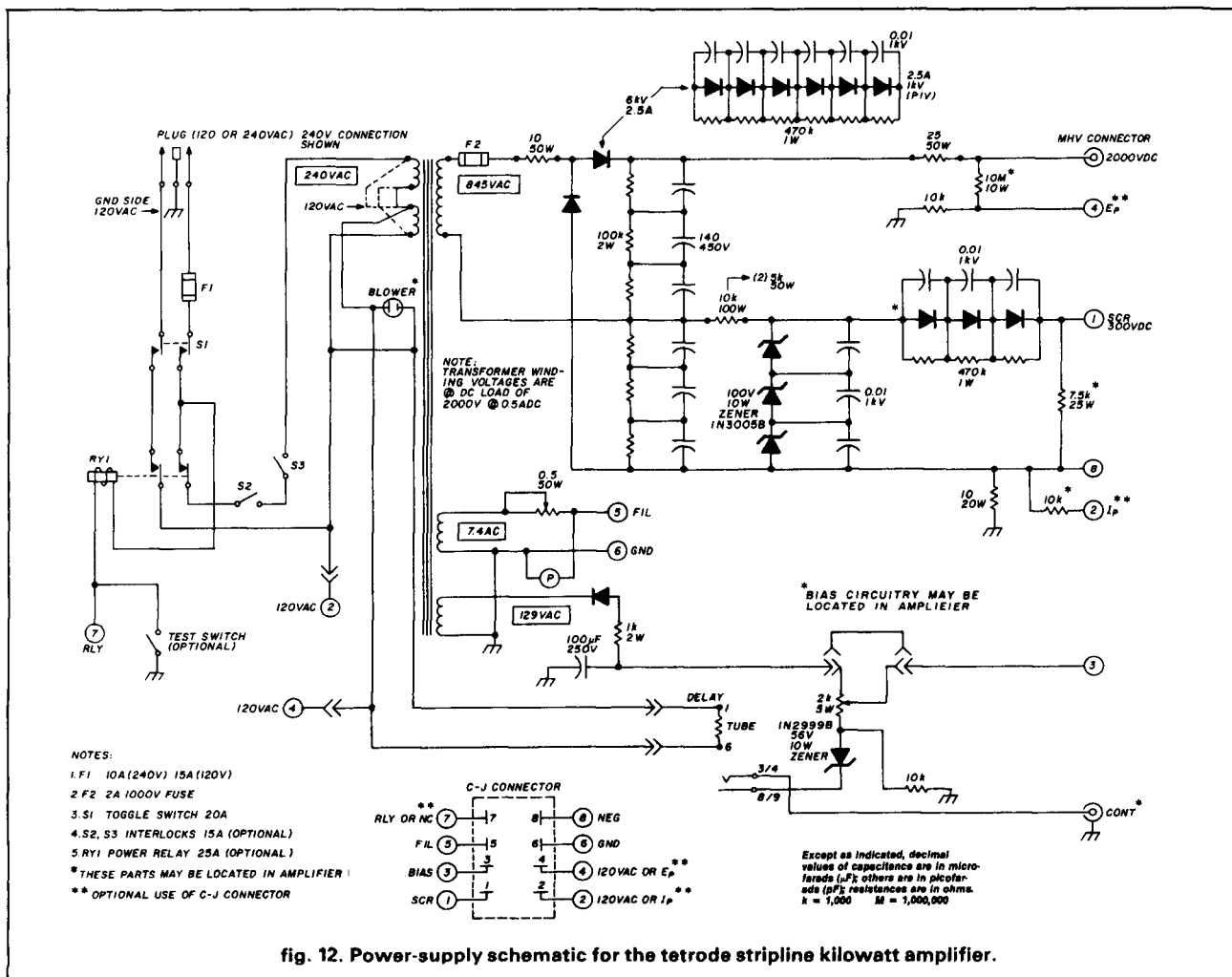
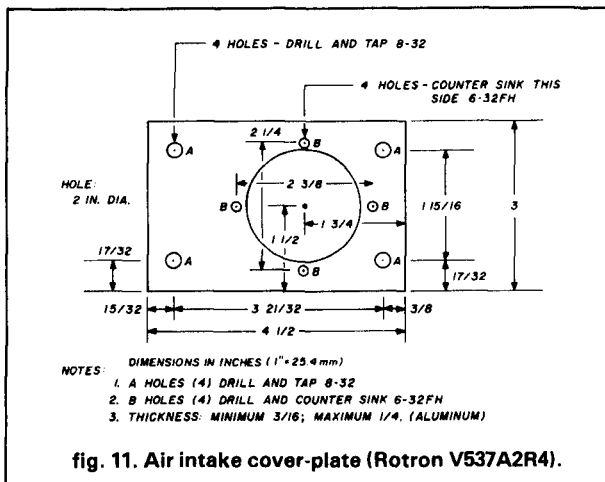

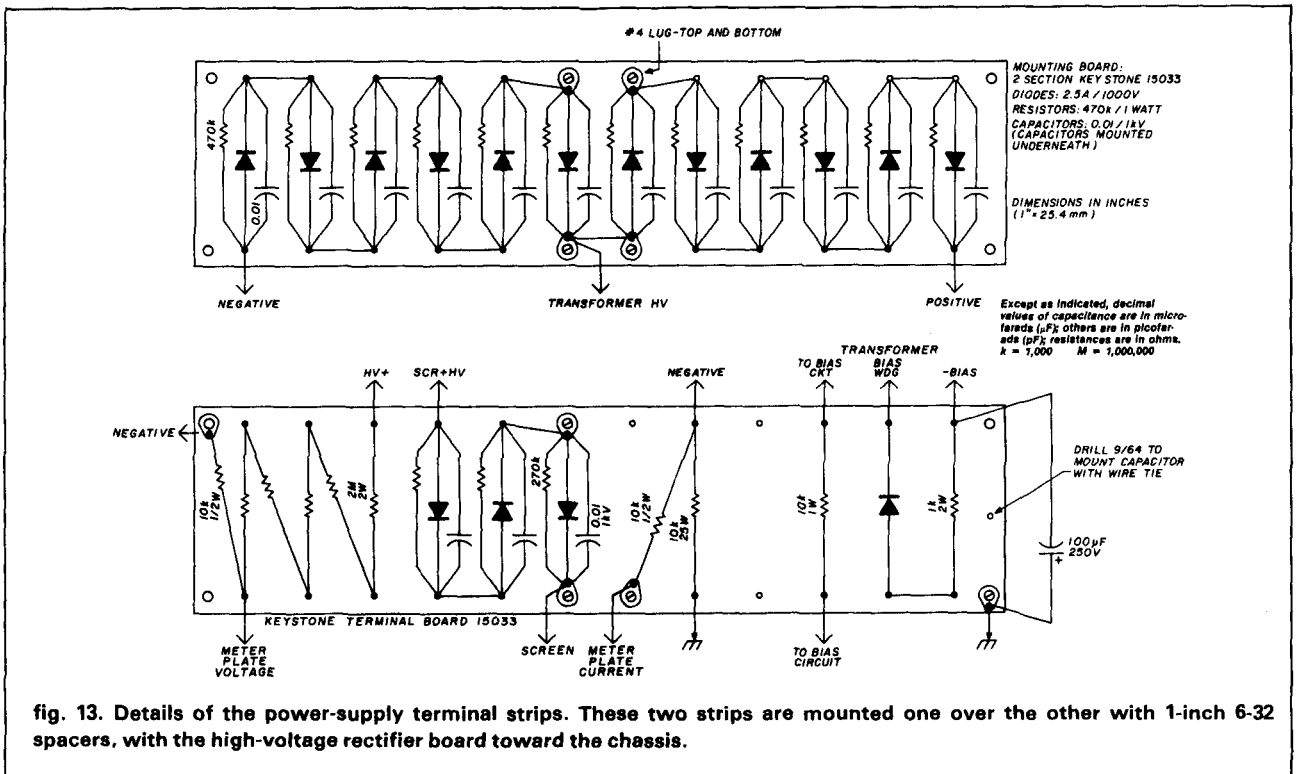

fig. 13. Details of the power-supply terminal strips. These two strips are mounted one over the other with 1-inch 6-32 spacers, with the high-voltage rectifier board toward the chassis.

design include compactness: 12 inches wide by 7 inches deep by 10 inches high (30.5 by 17.8 by 25.4 cm) and light weight (37 pounds, or 17 kg). All output voltages and other features to operate the amplifiers discussed above are provided. No-load output is 2300 volts dc. Outputs under loads of 1 ampere, 500 mA, and 100 mA are respectively 1850, 2000, and 2200 volts dc. Screen voltage is 300 volts dc regulated to 40 mA sink current. Cutoff and operating bias voltages are respectively -120 volts dc and -56 to -90 volts. (Operating bias is regulated at -56 volts dc.) Also provided are 7.6 volts ac, which is adjustable from 5.5 volts to 6 volts ac at 6 amperes. One-hundred-and-twenty volts ac are provided at the blower receptacle.

The transformer (custom manufactured by H. E. Johnson and Associates, Clearwater, Florida for ARCOS) has input provisions for either 120 Vac or 240 Vac, 50 to 400 Hz. Assembled around a 1540-watt hipsil core, the transformer is vacuum impregnated with insulating varnish then coated with a single-part thermosetting epoxy for mechanical protection. In ambient air of 25 degrees C with convection-radiation cooling only, continuous operation at 1000 watts dc results in a temperature rise of less than 30 degrees C.

The primary power circuit consists of a three-wire power cord, double-pole power switch, power relay (optional) and top and bottom cover interlock

switches (optional). A test switch (also optional) simulates the ground for operating the power relay, which comes from the associated amplifier over pin 7 of the low-voltage connector. The power cord must be sensed correctly for this feature to work with the 120-Vac connection.

A blower receptacle is provided. The power cord from the power supply blower, which is mounted on top of the power supply, plugs into the blower receptacle. The blower cord has a bridged receptacle to which the amplifier blower can be connected. Alternatively, 120 Vac may be connected to pins 2 and 4 of the power supply's low-voltage connector for operating the amplifier from a receptacle on the amplifier chassis. If this option is chosen, metering resistors for plate current and plate voltage must be located in the amplifier instead of in the power supply.

A review of the schematic will show that a voltage-doubling circuit is used with over 30 μF of electrolytic capacitors in each leg of the rectifier circuit. Six 1000-volt PIV/2.5-amp diodes are used in series in each rectifier leg. The diodes are protected by a secondary fuse (2 amps/1000 Vdc) and a 10-ohm, 50-watt series resistor. The short-circuit current is limited in the high voltage lead by a 25-ohm, 50-watt resistor.

The voltage doubling circuit provides a 1000-Vdc output for developing regulated 300-Vdc screen

voltage (pin 1 of the low-voltage power connector) by using a series resistor and zener diodes. The zeners are protected from high-voltage transients on the screen leads from the amplifier by series diodes in the screen lead. The screen terminating resistor may be located either in the power supply or in the amplifier.

The screen series resistor and screen terminating resistor values were chosen to maintain regulation with a 40-mA sink current in the screen terminating resistor. Adequate sink current for the screen circuit is essential to the proper operation of tetrode amplifiers. The sink current path through the terminating resistor provides a bleed path for the reverse screen current, which is normal for tetrodes. As I mentioned previously, if an adequate bleed path is not provided, the screen voltage will attempt to rise to the plate voltage and the tube will go into a runaway condition unless protected by surge voltage protectors at the screen-socket terminals. The 40 mA sink current provided for the screen terminating resistor in this power supply meets the tube manufacturer's recommendation for at least 15 mA per tube.

The series diodes in the screen lead block any high-voltage transients, which can occur in the time interval it takes for the surge voltage protection to operate, from destroying the zeners used for regulation.

The blower, mounted on top of the power supply over the vent slots near the screen-series resistors, provides cooling for approximately 100 watts of heat dissipation from the screen circuit components.

The grid-bias voltage (pin 3 of the low voltage connector) is regulated by a zener and is adjustable by a potentiometer. A delay tube is used to delay operating bias on the amplifier during warm-up. The bias changes from cutoff (-120 Vdc) to operate (-56 to -90 Vdc) when ground is placed on the control jack. Provision is made for metering plate voltage and plate current over pins 2 and 4 of the low-voltage connector (when these pins are not used, as described above, for 120 Vac to the amplifier chassis). Pin 5 of the low-voltage connector provides adjustable filament voltage to the amplifier. Pin 6 provides ground and pin 8 connects to the negative lead of the power supply. The high voltage is connected to the amplifier by RG-59/U coaxial cable using Amphenol MHV connectors.

The conductors between the amplifier and the power supply, other than the high voltage, are connected over an eight-conductor cable (Belden 8448) having one pair of No. 16 AWG conductors used for the filament voltage and ground. The other six conductors are No. 22 AWG.

Construction of the power supply is shown in the photos. The amplifier was assembled on a pre-

punched foundation chassis available from ARCOS. Diagrams of the terminal strips used to mount the high-voltage diodes, screen and bias circuitry, and so forth, are shown in fig. 13. Other construction details are included in fig. 14. There's nothing critical about parts location, so any convenient chassis arrangement may be used. Be sure to provide adequate ventilation for the screen resistors and zeners.

For use with the triode amplifier, the screen regulation and grid bias components are omitted (fig. 15). Note that the metering resistors for the triode amplifier are located in the amplifier.

test and operation

Connect the amplifier to the power supply and make the usual checks of blower operation, filament voltage, bias voltage, screen voltage and plate voltage. Set the bias for an idling current of about 100 mA for initial tests. Apply a watt or so of excitation and adjust the grid controls for maximum plate

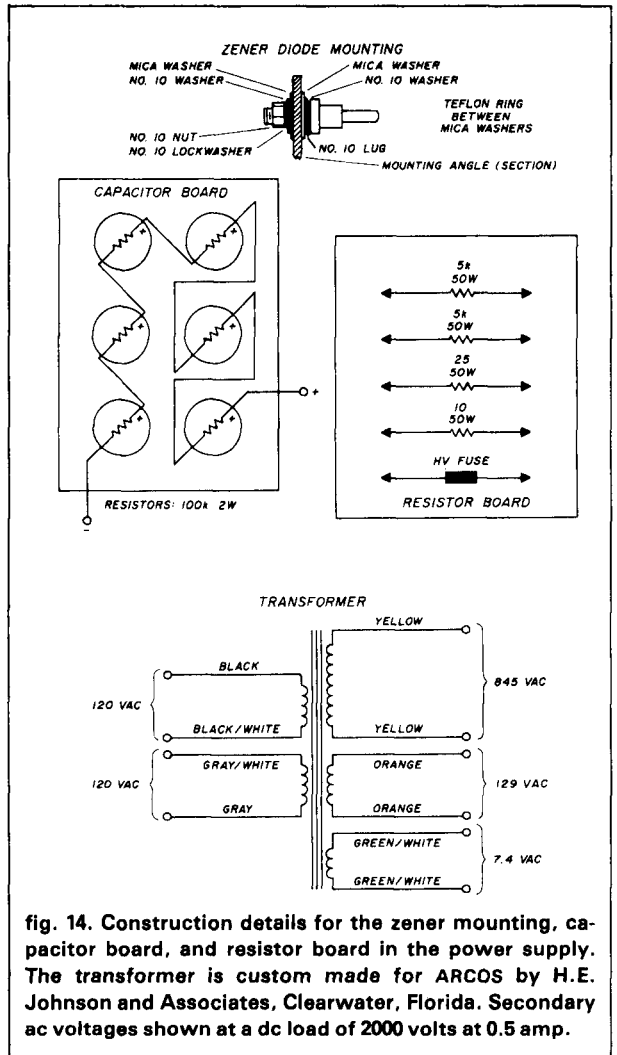

fig. 14. Construction details for the zener mounting, capacitor board, and resistor board in the power supply. The transformer is custom made for ARCOS by H.E. Johnson and Associates, Clearwater, Florida. Secondary ac voltages shown at a dc load of 2000 volts at 0.5 amp.

current. Then resonate the plate circuit by observing power output. If the plate circuit will not resonate, change the range of the plate-tuning flapper controls.

Increase drive until the output is at about 400 watts with the loading control about 1/8 inch (3 mm) above the top plate. Now set the grid controls for minimum

SWR toward the driving source. Next, adjust the plate load and tune controls for a compromise between maximum output and minimum plate current at an output level of 500 to 600 watts. See table 1 for a typical set of readings taken during the test of one of these amplifiers.

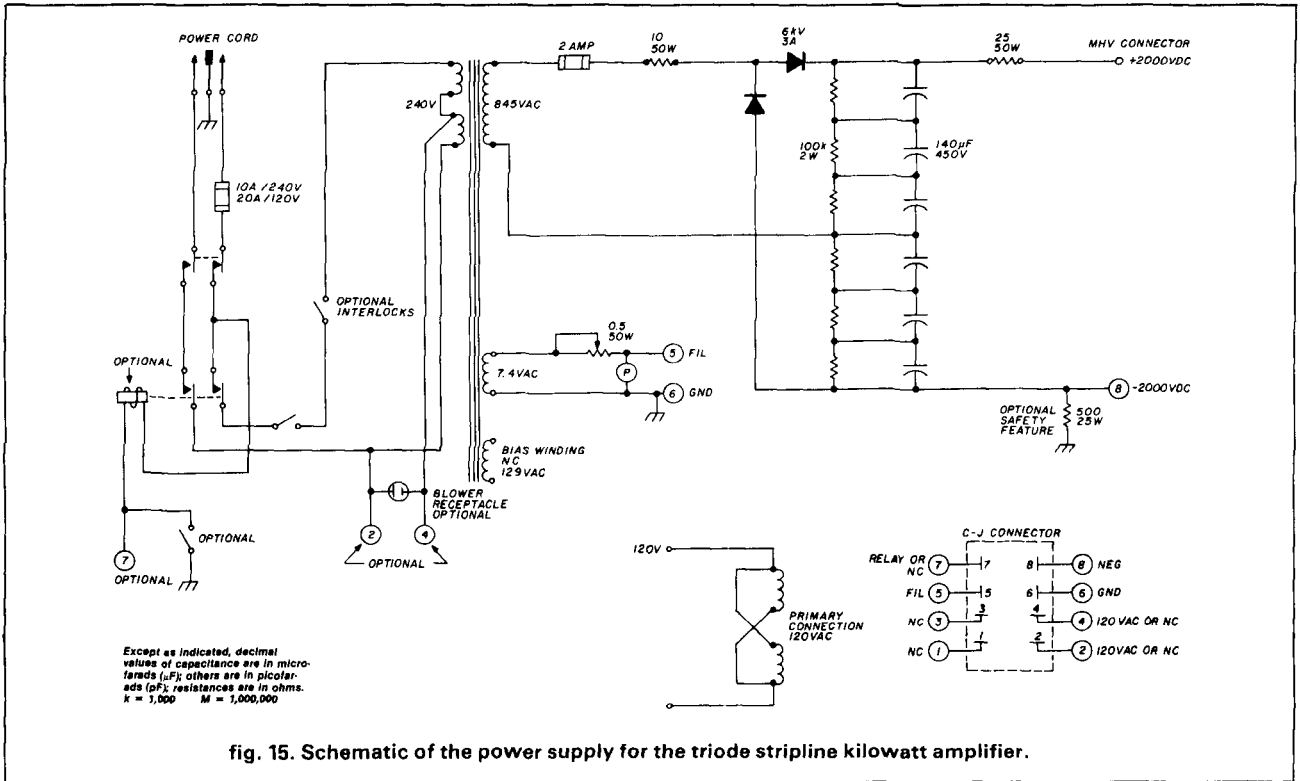

fig. 15. Schematic of the power supply for the triode stripline kilowatt amplifier.

table 1. Typical test results for the 220-MHz amplifier.

E _{fil} (volts)	E _{grid} (volts)	E _{scr} (volts)	E _{plate} (volts)	I _{grid} (mA)	I _{scr 1} (mA)	I _{scr 2} (mA)	I _{plate} (amp)	drive RFO (watts)	output (watts)	input (watts)	temperature	
											1 (F)	2 (F)
5.9	-92	380	2350	—	—	—	.100	—	—	235	128	128
5.9	-92	379	2200	0	-6	-2	.280	4	6	280	180	180
5.9	-87	378	2100	-1	-5	-1	.540	6	12	600	170	170

tubes: 4CX250R

dummy load: 150 ft (46 meters) of RG-8/U terminated by a Heath Antenna.™

operation: Class AB1

Notes:

1. Temperature 1 and temperature 2 refer to the temperatures at the two exhaust ports.
2. Efficiencies are 45 percent on line 2 and 53 percent on line 3.
3. RFO readings are the relative power output on the multimeter of the amplifier.
4. The negative grid and screen currents are normal for this type operation.
5. Observe the excellent screen voltage regulation.
6. Plate voltage regulation is 11 percent.
7. At 1-kW input the power output would be about 540 watts on CW for this operation condition.
8. SSB inputs can exceed the above figures somewhat if desired.
9. Key down on CW at 1 kW input, the tubes are within their dissipation rating (500 watts).
10. Power readings were taken with Bird 43 wattmeters in both drive and output.

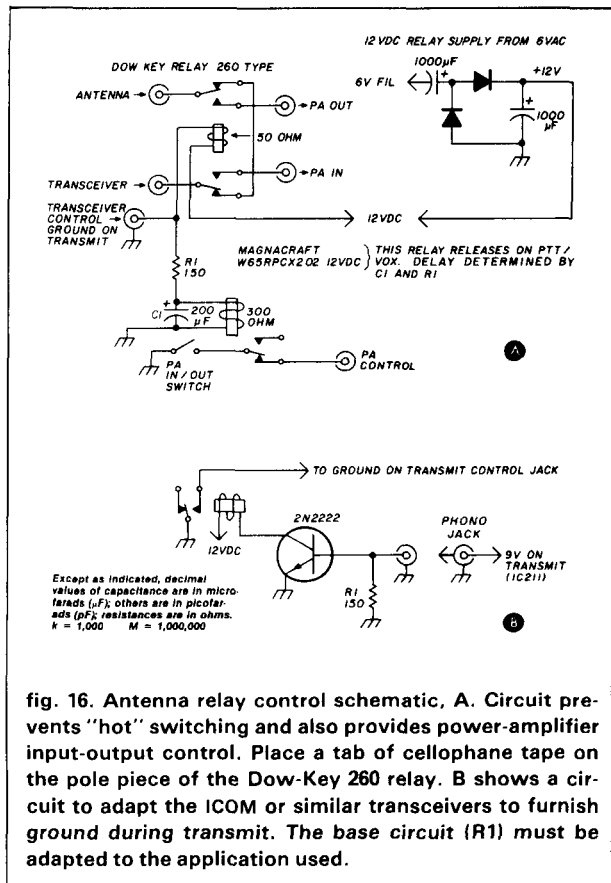

fig. 16. Antenna relay control schematic. A. Circuit prevents "hot" switching and also provides power-amplifier input-output control. Place a tab of cellophane tape on the pole piece of the Dow-Key 260 relay. B shows a circuit to adapt the ICOM or similar transceivers to furnish ground during transmit. The base circuit (R1) must be adapted to the application used.

A relative indication of the effectiveness of cooling, as well as the relative dissipation shared by the two tubes, can be obtained, as suggested by $K2R1W^2$ by mounting a candy thermometer over the air outlets. Temperatures read in this manner should not exceed 200 degrees F (93.5 C) under any condition. The thermometer is equipped with a pair of stiff wire legs, which facilitate setting it on top of the amplifier over the exhaust holes.

A failure of the air supply, if undetected, will result in a very rapid and disastrous temperature rise inside the plate compartment. Usually the solder on the plate line melts and the finger stock springs out to touch the chassis — grounding the high voltage and operating the high-voltage fuse. In cases observed so far, the tubes have survived. To prevent damage, an air switch in the blower or a pressure switch for the plate compartment may be used to shut down the power supply or bias the amplifier to cutoff when air pressure fails.

A suggested setup for switching the antenna when using a transceiver for drive power is shown in **fig. 16**. Some transceivers don't furnish grounds on transmit, providing either 12 Vdc or some other voltage. There's not enough current available in some cases to operate a relay. A transistor and relay may be con-

nected as shown in **fig. 16** to accept a voltage on transmit and produce a ground to operate the antenna-switching circuit. Note that a 12-Vdc supply is required for the above circuit. This may be obtained from the 6 Vac on the filament line as indicated.

references

1. Fred Merry, W2GN, "Stripline Kilowatt for 2 Meters," *ham radio*, October, 1977, page 10.
2. Richard T. Knadle, Jr., W2RIW, "A Stripline Kilowatt for 432 MHz," *QST*, April, 1972, page 48; May, 1972, page 59.

appendix

Errata in the October, 1977, article¹ on the two meter amplifier should be considered during construction.

Page 11 — fig. 1: "B" lead to meter switch is not shown. It is a direct lead from the opposite side of the 10-ohm metering resistor. (Opposite from the "A" lead.)

Page 12 — Caption on **fig. 3** should read 8930.

Page 13 — The caption of **fig. 5** is correct, but the drawing should be interchanged with that of **fig. 10**.

Page 13 — (fig. 4): The 3/8-inch dimension shown on the right side view should be 3/4 inches. The Dayton blower referred to in the text is model 4C012A. (The blower now recommended is Dayton 4C443. A different blower mounting plate is required.)

Page 15 — The dimension 1-7/8 inches (upper left) for the center line of the socket holes should read 1-5/8 inches.

Page 17 — (fig. 10): See note concerning page 13, **fig. 5** above.

Page 19 — (fig. 13): (upper right) — the dimension not shown for the self-crimping nuts on the lower piece of the plate line is 1/4 inch.

Page 20 — (fig. 14): Aluminum support block — the vertical holes in the block should be 1-1/4 inches apart (not 1-1/8). The width of the fixed plate-line capacitor plate is 1-1/8 inches, not 1-1/2 inches.

Page 21 — (fig. 15): The grid coil is three turns, 5/8 inches diameter, 3/4 inches long, No. 16 AWG.

Page 21 — (fig. 15): The butterfly capacitor mounts are made of G-10 glass epoxy laminate having a thickness of 0.06 inch.

Page 21 — The dimension between the holes in the copper strap is 2-9/16 inches not 2-9/32.

Improvements developed since the October, 1977, article was published:

1. Surge-voltage protectors were added to the screen terminals of each socket.
2. The output (load) flapper assembly has been strengthened by mounting it on a Teflon block. A large Teflon button is mounted in a hole in the load flapper on which the adjustment screw bears. The adjustment screw was changed to a 1/4-inch thread cap screw. With this arrangement, there is no strain on the center conductor of the output connector, and mechanical stability is achieved. The Teflon piece underneath the load flapper is not required.
3. In the original design, the plate-tuning flapper was quite close to the plate line at resonance, which resulted in a tendency for it to flash over when loading was too light. To provide additional clearance and smoother tuning control, a padder capacitor of the flapper type was added above the plate line opposite the plate loading capacitor.
4. The zener regulators in the power supply are protected from high-voltage transients on the screen lead by a string of diodes.

ham radio

Barry Electronics Corp.

WE SHIP WORLDWIDE

WORLD WIDE AMATEUR RADIO SINCE 1950

Your one source for all Radio Equipment!

All Handy Talkies In Stock For Immediate Delivery!

VoCom 2 meter 5/8 Telescoping Whip & Duckie

Antennas & HT Amp's HEAVILY STOCKED

We Will Not Be Undersold Call: 212-925-7000

"Kitty Says"



SANTEC
HT-1200, ST-7/T
ST-144/UP

TEMPO
S1, S2,
S4, S5

YAESU
FT-208R
FT-708R

ICOM
IC2AT
IC3AT
IC4AT

DIGITAL
FREQUENCY
COUNTER

Trionyx-
Model TR-1000
0-600 MHz
Digimax-Model D-510 50Hz-1GHz

FM-205

MIRAGE
B-23,
D-1010,
B-1016

ICOM IC-720A, IC-730
IC-25A, IC-251A, IC-2KL, IC-451A

HY-GAIN
TOWERS
& ANTENNAS

KANTRONICS
Mini-Reader
Field Day

DRAKE TR-5, TR-7, R-7, L-7,
L-15, & Theta-7000E

TEN-TEC
Omni "C"

YAESU
FT-ONE

FT-101ZD MARK III, FT-480R,
FT-707, FT-720RU, FT-720RVH,
FT-902DM, YR-901-CW/RTTY

ROCKWELL/COLLINS
KWM-380

ROBOT 400 & 800

MURCH Model UT2000B

AEA Morse Matic,
MBA & IsoPole Antennas

BIRD
Wattmeters &
Elements
in stock

ASTRO 103 150A & 100 MXA
DIPLOMAT 150

SPECIAL! FTZ-720 RU Mobile Transceiver 440-450 MHz (also available 430-440 MHz) \$299.00. FTZ-720 RVH 144-148 MHz Super Special \$299.00. WHILE THEY LAST!

New York City's LARGEST STOCKING HAM DEALER
COMPLETE REPAIR LAB ON PREMISES

WE STOCK ARRL & BASH PUBLICATIONS.

MAIL ALL ORDERS TO BARRY ELECTRONICS CORP.,
512 BROADWAY, NEW YORK CITY, NEW YORK 10012.
BARRY INTERNATIONAL TELEX 12-7670 212-925-7000
TOP TRADES GIVEN ON YOUR USED EQUIPMENT.

**"Aqui
Se Habla
Espanol!"**

WE STOCK: KLM ANTENNAS, UHF & VHF AMPLIFIERS, NEW
ROBOT MODEL #800, BIRD WATTMETER, HY-GAIN, LARSEN,
SHURE, KDK-2015R, TURNER, ASTATIC, VOCOM, VHF ENG.,
MFJ, KANTRONICS, AVANTI, CORDLESS TELEPHONES,
POCKET SCANNERS, NYE, BENCHER, VIBROPLEX, ALPHA.

AUTHORIZED DIST. MCKAY DYMEK FOR
SHORTWAVE ANTENNAS & RECEIVERS.

WE NOW STOCK COMMERCIAL COMMUNICATIONS SYSTEMS
DEALER INQUIRIES INVITED. PHONE IN YOUR ORDER & BE REIMBURSED.

Amateur Radio Courses Given On Our Premises

Export Orders Shipped Immediately.

ham radio TECHNIQUES

Bill W6SAI

I was young once and knew everything. One of my beliefs was in the honest-to-gosh reading of an SWR meter. You merely put it in the line to the antenna and this magical instrument would tell you just what was happening inside the coaxial line. It was all very simple. Fortunately, I learned rapidly, and in the process amassed six or seven SWR meters. It was always amusing to make SWR measurements on an antenna with one meter and then to repeat the measurements with another meter. It was almost possible to hand-pick the SWR curve I wanted by the correct choice of instrument, since they provided widely different readings.

I'm not the only Amateur who has been led down the daisy path by the SWR meter. The complications associated with this interesting device are more important today than ever before because of the advent of the solid-state, high-frequency transceiver.

the more you have the less you get

Most high-frequency transmitters that have a solid-state power amplifier incorporate a protective circuit that will gradually turn off the amplifier as the SWR on the antenna system rises. Since most antennas are single-frequency devices (that is, adjusted at one spot in a particular

band), a low value of SWR is obtainable at only one frequency. Operating the antenna off frequency causes the SWR on the feed system to rise, even though the antenna may work in excellent fashion across the whole band (fig. 1).

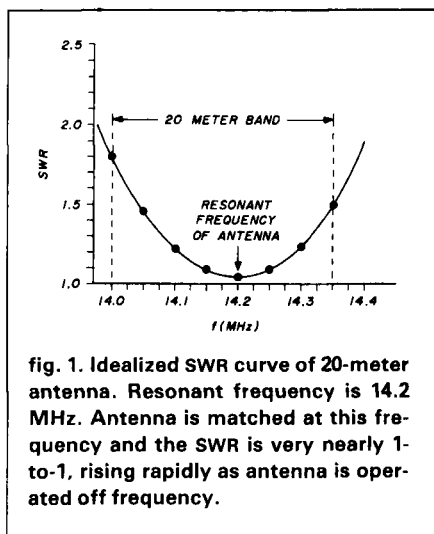

fig. 1. Idealized SWR curve of 20-meter antenna. Resonant frequency is 14.2 MHz. Antenna is matched at this frequency and the SWR is very nearly 1-to-1, rising rapidly as antenna is operated off frequency.

Tube-type amplifiers with their adjustable output controls (TUNE and LOAD) can adapt themselves to wide variations in the SWR of the antenna system. The solid-state wide-band amplifier, on the other hand, requires protection against SWR excesses. Hence the fail-safe shut-down design. When the SWR starts to rise, the amplifier transistors are electrical-

ly derated for protection.

All well and good, I say, but the user of such equipment must pay attention to the SWR across his band of operation, or he will find that he can get full power output from his rig only over a small portion of the band. This vexing problem is particularly true on 160, 80, and 10 meters, where the width of the band is large in proportion to the center frequency.

enter the SWR meter

To determine just what is going on with regard to a particular antenna, an SWR meter is commonly used to gain a picture of SWR vs frequency, as shown in fig. 1. But is this a true picture of what is happening? Possibly not. A knowledge of the workings of the SWR meter and its use are of utmost importance.

Most modern SWR meters are composed of two directional couplers built into one case. A single indicating meter is switched between the couplers and the meter is usually calibrated directly in terms of SWR (standing wave ratio).

A directional coupler is a device which samples power flowing in one direction in a transmission line but is insensitive to power flowing in the reverse direction.

If the antenna exactly matches the characteristic impedance of the transmission line and also matches the line

with respect to balance, it will absorb all power transmitted down the line. If a mismatch exists at the antenna, a certain portion of rf power will be reflected back down the line toward the transmitter.

The circuit in the directional coupler picks up energy from the line by means of both inductive and capacitive coupling. The inductive current in the line flows according to the direction of the traveling wave producing it. Thus there can be direct and reflected waves passing through the coupler. The capacitive pickup, however, is independent of the direction of the traveling waves, and the sum of coupled currents in the device produced from the waves of one direction will add in phase. Those produced from waves of the opposite direction will subtract in phase.

The electrical balance of a coupler is such that the current induced from the reverse-traveling wave will cancel the other completely, or nearly so, resulting in a directivity factor in the coupler. This means the coupler is highly insensitive (nulled) to a wave traveling in the reverse direction. Thus the device is sensitive to only one of the traveling waves which produces standing waves by interference. To determine SWR it is necessary to read forward and reverse (incident) power flowing in the line. Two couplers, reverse connected, can do the job (fig. 2). In order to obtain accurate readings, both couplers must be identical. And each coupler should be insensitive to power passing through it in the unwanted direction.

The important characteristic of a coupler is the ratio of the measurement in the forward direction to that in the reverse direction. If the coupler is sensitive to the unwanted reading, the accuracy of the coupler is seriously affected. When two couplers are used to make up an SWR meter, the problem is compounded.

A good laboratory-type coupler will have a directivity of better 25 dB, indicating that the coupler provides 25 dB of discrimination between opposite directions of power flow. An

SWR meter made up of two such couplers provides an indicated value of SWR differing from the true value, as shown in fig. 3. As an example, a true value of SWR of 1.5-to-1 on a transmission line can provide an indicated value on the SWR meter which can vary between the extremes of 1.23-to-1 and 1.8-to-1. And most cheap CB-type SWR instruments are not this accurate.

Added to the directivity limitation, most inexpensive SWR meters have a built-in error because of the non-linearity of the diode used to provide voltage for the indicating meter. At low voltage levels where the SWR reading is of the greatest importance, diode linearity is poorest.

Finally, all directional couplers are sensitive to second harmonic voltage that may exist in the antenna circuit. Since the antenna is mismatched at harmonics, it is possible for high SWR to exist at a harmonic frequency and

if the coupler is accidentally placed at a point in the line having high harmonic current, pickup of this current will adversely affect the reverse reading of the coupler.

You may scoff at this notion, and say that the second harmonic level of your transmitter or exciter is "down 35 dB," or some such number. Well and good, but just remember that with a high value of antenna mismatch reflection at a harmonic, the harmonic voltage passing through the coupler may be many times higher than you suppose. And don't forget that when a coupler is measuring the reflected wave in a line, it may be measuring as high as 40 to 50 dB below the fundamental signal level. That is to say, the unwanted harmonic voltage can easily be of the same order of magnitude as the measured reflected wave.

For best results, therefore, I suggest you buy the best SWR meter you

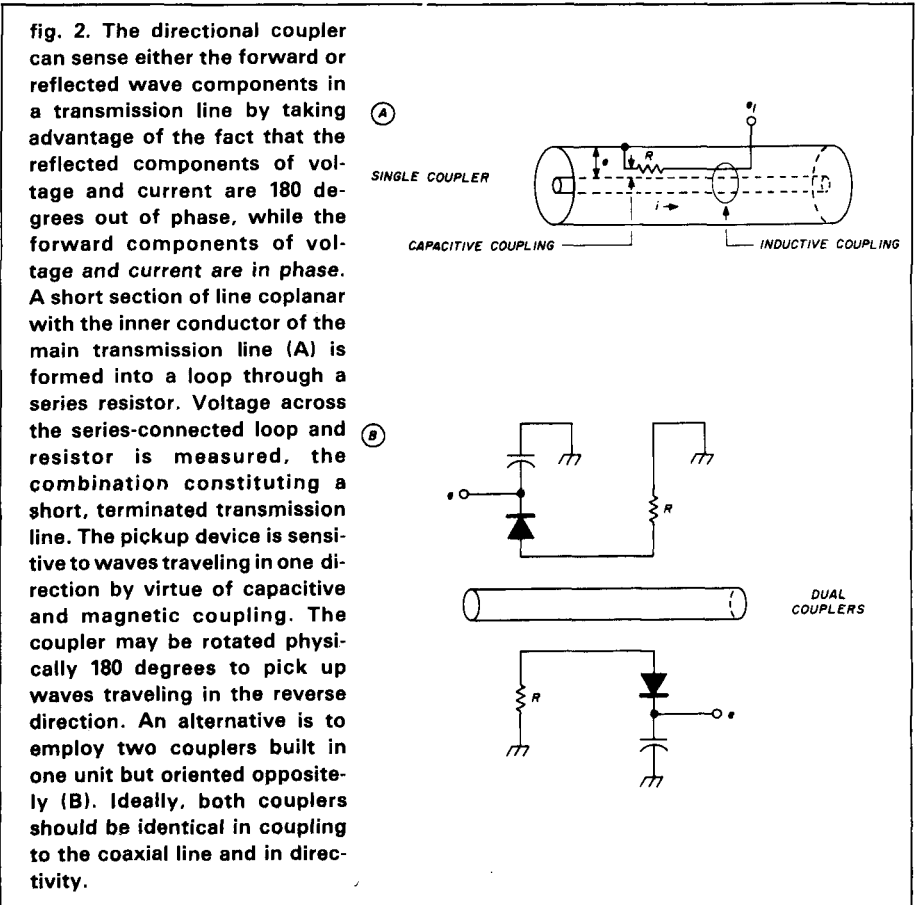
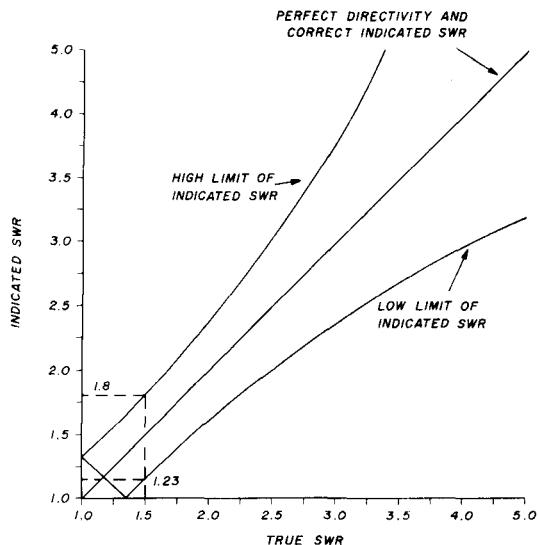

fig. 3. Extreme limits of indicated SWR versus actual SWR for a coupler having 25 dB of directivity. (Adapted from "Possible Errors in VSWR Measurement," Breetz, *QST*, November, 1959.)



tenna system (due to inductive coupling to the antenna) and thus becomes part of the load on the line, in addition to the antenna load. The SWR on the line is now determined by the composite load of the antenna and the outside of the line.

This is one reason why changing the length of the transmission line changes the SWR reading. The portion of the load caused by unwanted line coupling is being changed!

how to reduce unwanted line currents

To achieve an accurate SWR reading on your transmission line it is necessary to detune and decouple

can afford. Some SWR meters are made up of two directional couplers, back to back. Others have a single coupler with a reversible element. I prefer the latter type. One coupler made in the U. S. A. has plug-in heads for various frequencies and power levels. It is useful for both hf and VHF antenna measurements. While I don't believe in "plugging" name brands in this column, be assured this high-flying instrument is really a Bird!

pitfalls in making SWR measurements

So now you have a good SWR meter! Congratulations. If you use it properly, you'll get meaningful information. But you just can't jam it into a coaxial line and expect the instrument to do its job. It is up to you to make sure that the meter reads what you are looking for (true SWR of the antenna) and not a jumble of information resulting from unwanted coupling between the transmission line and the antenna. Let me explain.

Any conductor in the field of an antenna is coupled to it inductively. The degree of coupling depends upon the position of the conductor with respect to the antenna and the distance between antenna and conductor. A good example of such a conductor is a parasitic element in a

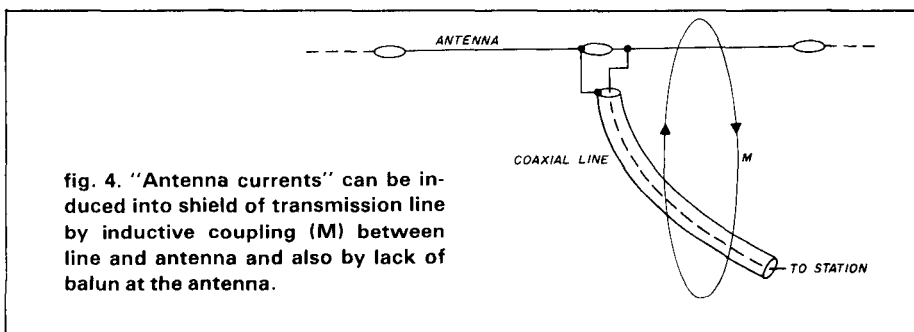

beam antenna. It is closely coupled to the antenna and tuned closely to its frequency.

Other conductors coupled to your transmitting antenna are overhead power lines, telephone lines, and your transmission line.

Yes! The outer shield of a coaxial line can be inductively coupled to the antenna if it runs parallel, or nearly so, to the antenna and is elevated above ground level. An example of this is shown in **fig. 4**, a typical antenna installation.

Antenna current induced on the outer shield of a transmission line will influence the SWR reading of currents within the line, as the outer shield is no longer at ground potential, even though the SWR meter and transmitter are supposed to be near ground potential. The outside of the coax line has become part of the an-

table 1. Recommended non-resonant transmission line lengths (L) for the high-frequency Amateur bands. Lengths indicated include distance between one tip of driven element and feed point, plus coaxial line length.

23 - 30 ft.	158 ft.
35 - 44 ft.	164 ft.
46 - 47 ft.	
52 - 63 ft.	
71 - 81 ft.	
86 - 90 ft.	
93 - 97 ft.	
106 - 112 ft.	
141 - 147 ft.	

(Adapted from *The ARRL Antenna Book*)

the line from the antenna. Certain lengths of transmission line, as measured between one tip of the antenna and the SWR meter (L) are not resonant in the Amateur bands (**table 1**). Cutting the transmission line to rec-

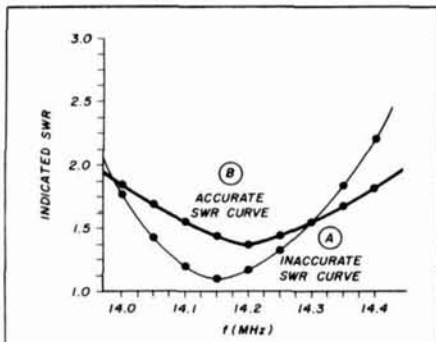

fig. 5. (A) Measured SWR curve with unwanted antenna currents flowing in outer conductor of coaxial line. Curve indicates antenna system resonance near 14.15 MHz with very low SWR. The more accurate curve run with antenna currents on line suppressed shows a flatter response, with higher value of minimum SWR at 14.225 MHz. Classic curve of measurement A may lull Amateur into thinking he has a perfect match, whereas the correct curve (B) shows match is not quite so good.

decoupling the transmission line

Let's assume that your situation is this: You have a tri-band beam for 20-15-10 meters atop a 40 foot tower. The coax feedline runs down the tower to the 10 foot level and then runs along your roof for about 20 feet to the station, then drops down to near ground level, entering a window near the transmitter. You make SWR measurements across each band and get a reassuring set of curves that bear a little resemblance to the "typical" curves supplied by the manufacturer. How can you determine your curves are valid?

The easiest and quickest check is to add four or five feet of coaxial line between the SWR meter and the antenna and rerun the SWR curves. If the shape or amplitude of the SWR curves change, it is a good bet that you have unwanted coupling between the antenna and transmission line. Of course, to make this experi-

ment, it is understood that the unbalanced, coaxial line is properly terminated at the antenna in a balun or other device which provides a match between the unbalanced line and the balanced driven element of the beam. (Note: Such a test is valid *only* if you have a good SWR meter.)

If you find that interaction between line and antenna exists and it is impractical to move or otherwise change position of either the line or the antenna, what is to be done?

One helpful and easy thing to do is to coil the line into a simple rf choke at the foot of the tower. Four or five turns about a foot in diameter, taped together with electrical tape, will help to "cool off" the line at the tower.

At the station end of the line, a second, similar coil may help solve the problem. The coil can be made by splicing an extra length of line into the system with coaxial adapters. After the coils are in place new SWR runs are made, with and without the extra spliced-in line section. Now, do

ommended lengths helps, but is not a total cure to the problem.

Of equal importance is the fact that the transmission line should not run parallel to the antenna elements. And it should be positioned close to the ground and not suspended above the ground. This is a large order when a rotary beam is used because at some beam heading the antenna elements will probably run parallel with the transmission line. The best solution is to run the coaxial line along the ground from the antenna tower to the station, or bury it beneath the ground in a section of water hose. The worst thing is to run the coaxial line a long distance above the ground from tower to station (along the roof top, for example). This places the coax line up in the air and closer to the active antenna.

But what do you do when it is impossible to cut line length to a recommended value and the line must run along the rooftop in the vicinity of the antenna? Obviously, induced antenna currents are going to flow in the outer conductor of the line. How can SWR measurements made under these conditions be trusted?

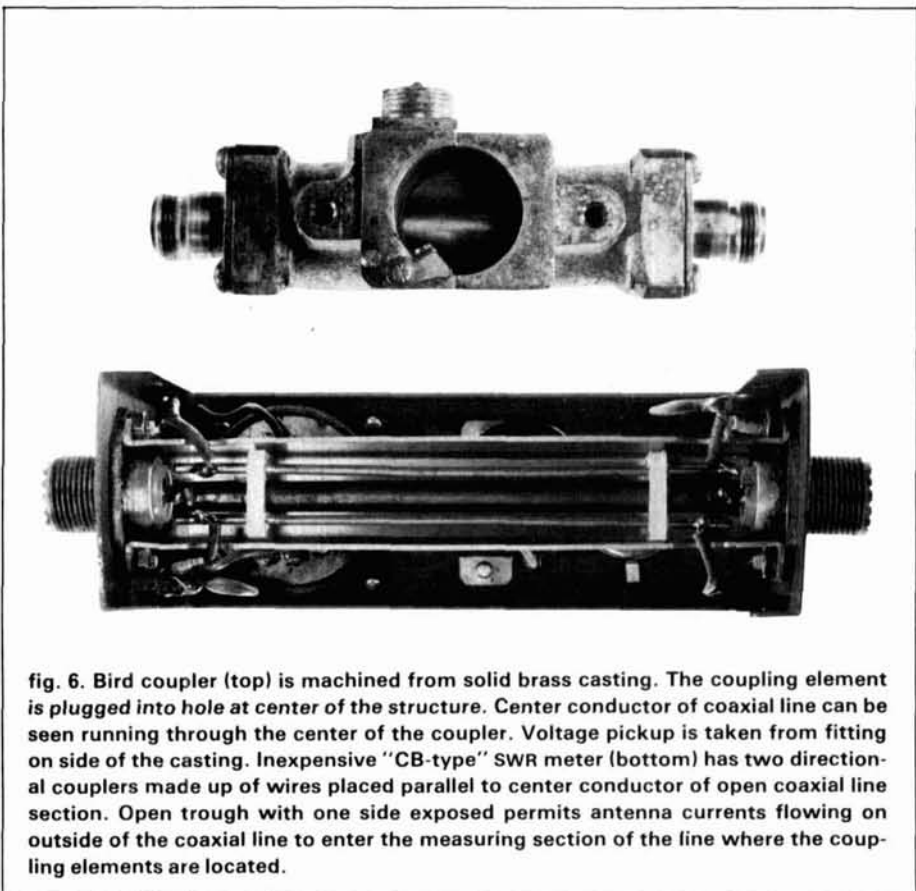

fig. 6. Bird coupler (top) is machined from solid brass casting. The coupling element is plugged into hole at center of the structure. Center conductor of coaxial line can be seen running through the center of the coupler. Voltage pickup is taken from fitting on side of the casting. Inexpensive "CB-type" SWR meter (bottom) has two directional couplers made up of wires placed parallel to center conductor of open coaxial line section. Open trough with one side exposed permits antenna currents flowing on outside of the coaxial line to enter the measuring section of the line where the coupling elements are located.



THE CONTESTER™

Computerized Morse Code Keyer

WITH THE NEW AEA MODEL CK-2, YOU TOO CAN HAVE THE WINNER'S EDGE

Operates from external 12VDC @ 200 ma.

NEW ... \$99.95

The model CK-2 "CONTESTER" is part of the latest generation of famous AEA computerized electronic keyers. Like many of our other innovative electronic products, the Contester™ keyer utilizes a custom AEA microcomputer with proprietary copy-written software. The CK-2 retains virtually all the remarkable features of the CK-1 predecessor such as an automatic serial number generator, large soft-partitioned memory with editing capabilities, etc. In addition, we have added CMOS memory with internal battery keep-alive provisions, automatic repeat mode and a **lower price!** See it now so you too can appreciate the fine quality of design and craftsmanship that goes into all AEA products.

ACCESSORIES:

- AC-2 350 Ma 12 VDC Wall Adaptor \$9.95
- DC-2 Mating Rechargeable 8 hour Battery Pack and Charger \$39.95

PRICES AND SPECIFICATIONS SUBJECT TO CHANGE WITHOUT NOTICE

call or visit:

TOLL FREE 800-336-8473
TUE-SAT 10AM-4PM EST

EEB

516 Mill Street, N.W.
Vienna, Va. 22180
(703) 938-3350

AEA

Brings you the Breakthrough!

2300 MHz MICROWAVE DOWNCONVERTERS

DOWNCONVERTER

- Kit \$28.50
- Assembled \$48.50

2300 MHz PREAMP

- Kit \$25.00

POWER SUPPLY

- Assembled \$35.00

SATELLITE TV EARTH STATION

- 24 Channel Receiver
- 10' Antenna
- Dexcel 120° LNA

Call for details and price

Also Available: Commercial System with Bogner Antenna \$169.00

2300 MHz ANTENNA



WITH BOX FOR DOWN-CONVERTER
\$27.50

PB RADIO SERVICE

1950 E. PARK ROW • ARLINGTON, TX 76010

CALL ORDER DEPT. TOLL FREE
(800) 433-5169



FOR INFORMATION CALL
(817) 460-7071

the two sets of measurements agree within reason? If they do, your transmission line is decoupled from the antenna (fig. 5). Don't expect the curves to match exactly; a degree of line coupling can still exist, particularly if the transmitter or exciter are enclosed in a "leaky" cabinet that permits rf to pass from the transmitter circuits to the outside of the cabinet (most of today's modern transmitters fall into this regrettable category).

a final word on SWR meters

The name of the game is to keep all the rf bottled up inside the transmission line up to the antenna and let none of it escape along the outside of the coaxial line. This will provide the most reliable SWR indication. But all your good efforts may go for naught if you choose a poor SWR meter! Look at fig. 6. This photo compares the directional element of a Bird coupler with an inexpensive, imported "CB-type" SWR meter. Note that the coupling element of the cheap device is an open trough, with one side exposed, providing excellent coupling between the wanted measurements and any induced waves traveling along the outside of the coaxial line. The break in the line shield inside the SWR meter provides a perfect place for transmission line currents and unwanted induced currents to join — right at the point the measurement is being taken.

Don't throw out your cheap SWR meter, but don't put too much trust in it. Borrow a good directional coupler and place it in series with your SWR meter. See how the two compare in readings across your antenna's span of operation. Decouple your transmission line by keeping it close to ground level and winding it up into rf chokes at the station and tower ends of the line. Make sure you use a good balun at the antenna, if one is required.

More in my next column.

ham radio

For more information on the use of the SWR meter, the reader is referred to the just-published 22nd edition of the *Radio Handbook*, available from Ham Radio's Bookstore. Editor

Spring Picks For Your Bookshelf

1982 U.S. RADIO AMATEUR CALLBOOK

No Amateur station is complete without the very latest Callbook! The 1982 U.S. Callbook features over 390,000 up-to-date names and addresses right where you want them — at your finger tips. Also contains many helpful operating and station aids. ©1981. Softbound.

CB-US \$18.95 + \$3.05 shipping (U.S.A.) = **\$22.00**

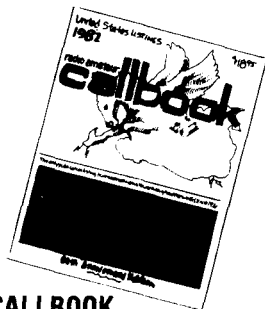

1982 FOREIGN CALLBOOK

If DX is your "thing" then you need a copy of the 1982 Foreign Callbook. Getting a QSL card can be quite a chore without proper names and addresses. Make sure you don't miss out. ©1981. Softbound.

CB-F \$17.95 + \$3.05 shipping (U.S.A.) = **\$21.00**

Get 'em both! You save money too!

CB-USF Only **\$39.95**

1982 ARRL RADIO AMATEUR'S HANDBOOK

Internationally recognized, universally consulted. It's the all purpose volume for radio. Jam packed with information, drawings, and illustrations that are useful to the Amateur and professional alike. Get your copy today. ©1981.

AR-HB82 Softbound **\$10.00**
 AR-BB82 Hardbound **\$15.75**

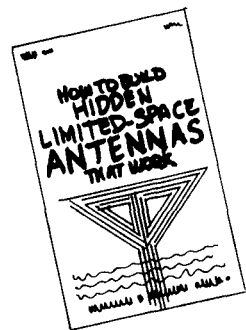

HOW TO BUILD HIDDEN, LIMITED SPACE ANTENNAS THAT WORK **Brand New**

by R. J. Traister

Space problems limiting your signal? It doesn't have to be that way. How-to book complete with plenty of projects on how to put out that big signal. Projects include suspended multi-band vertical, window antenna, attic dipole, 20m indoor antenna, two meter coaxial and much more. Softbound 308 pages. ©1981.

T-1254 **\$9.95**

PACKET RADIO

by Robert Rouleau, VE2PY and Ian Hodgson, VE2BEN

Packet Radio could be one of the most important technological developments in Amateur Radio this decade. Can you imagine getting your newspaper or paying bills through a computer terminal linked by radio with other computers? It's happening, **now**. And you should make yourself aware of all the amazing things packet radio can do for you. This comprehensive sourcebook explains all the principles of packet radio in an easy-to-understand, non-technical language. You'll learn all about modulation, bandwidths, polling, random access, data rates and more. Plus there is an overview of how the computer is integrated into the packet concept with discussions on the software and peripheral equipment that is used. Finally, the authors give you a detailed description of the packet system in use in the Montreal, Quebec area. ©1981, 1st Edition, 304 pages.

T-1345 Softbound **\$11.95**

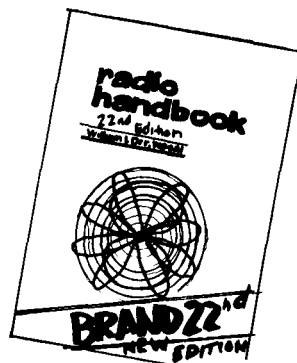

RADIO HANDBOOK

by Bill Orr, W6SAI 22ND EDITION

The Radio Handbook has been an electronic best seller for over 45 years! This brand new edition reflects all of the latest state-of-the-art advances in a comprehensive, single source reference book. An invaluable aid for Hams, technicians, and engineers alike. Also chock-full of projects and other ideas that are of interest to all levels of electronics expertise. 1136 pages. ©1981. 22nd edition.

21874 Hardbound **\$34.95**

BAND-AIDS

by James E. Dersch, KB7FT

This revised edition of **Band-Aids** contains a collection of the most often used operating aids, charts and tables that every Ham needs. Not only does it cover the fundamentals of operating, but it also contains operating aids for CW Communications, WWV and WWHH broadcasting schedules, DXCC check sheet and international prefixes, plus many other features. A handy reference data section includes conversion tables, metric data and abbreviations. ©1981. 156 pages.

CC-BA Spiralbound **\$9.95**

COMPLETE HANDBOOK OF RADIO RECEIVERS

by Joseph J. Carr, K4IPV

All-in-one manual. Contains complete data on almost all receivers in use today. Written in an easy-to-read manner, this handbook includes basic receiver types; specifications for the latest ideas in parameter measurements such as sensitivity, noise figures, dynamic range, and selectivity measurements. Also covered are all types of modern receiver circuits, and a wide range of troubleshooting ideas for both solid-state and vacuum tube receiver circuits. ©1980, 300 pages.

T-1182 Softbound **\$9.95**

Send today for a free book catalog. Chock-full of interesting books on all aspects of Radio Communications.

Can't wait? (603)
CALL TODAY 878-1441

For books other than US and Foreign Callbooks, please add \$2.50 to cover shipping and handling.

Ham Radio's Bookstore

Greenville, NH 03048

2716 EPROM programmer

Easy method for burning EPROMS with your microprocessor

Programming read-only memories (ROMs) is a virtual necessity if you're developing microprocessor-controlled ham gear. Many microprocessor systems, such as the KIM, SYM, and AIM, are capable of developing and debugging simple control programs, but none have ROM programming capability. As a first step to integrating microprocessor control into my projects, I found that I needed something to go with my KIM that would program and read erasable programmable read-only memories (EPROMs). The circuits presented here will work with the KIM, SYM, and AIM and are adaptable to other microprocessor systems.

what is an EPROM? why program one?

Solid-state memory for microprocessors comes in

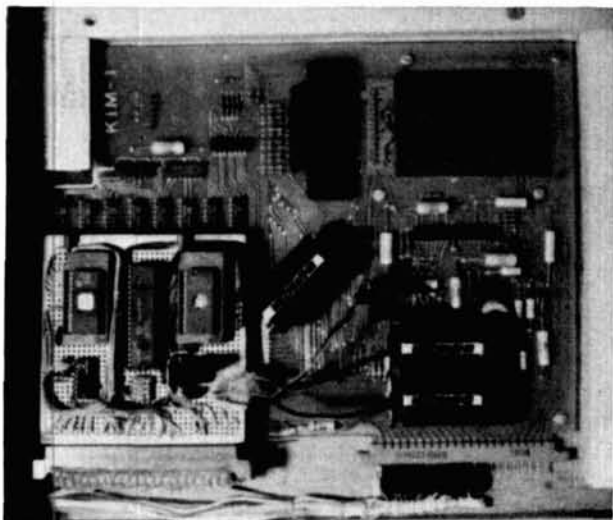

The completed unit. The PPI is the large IC in the center of the board. The programming socket is to its right and the read socket to the left. The regulator with a heatsink is mounted vertically at the bottom right corner of the PPI. The regulator bypass capacitor is between it and the battery connectors.

two forms, random-access memory (RAM) and read-only memory (ROM). The former is a general-purpose memory that can be used to store both program and data material. Information stored in it may be changed at will.

ROM is used for permanent programs and their constants. As the name implies, it can be read only. If scratch pad space beyond that contained in the microprocessor is required, it must be supplemented with RAM.

The shortcoming of RAM is that it is volatile; that is, if the power is removed the RAM forgets. Many schemes for making RAM more permanent are available, such as battery or large-capacitor power supply backup, but in the long run permanent programs should be stored in some sort of nonvolatile ROM. This places them beyond the reach of power failure and programming errors, which would leave a RAM filled with garbage.

An additional advantage of ROM is that microprocessor chips, when powered up, awaken seeking the address of their first instruction at a particular location. If the program stored in the ROM has the correct addresses, pointing the way to the beginning of the program, the routine will be self-initiating when powered up. In other words, the operator doesn't even have to know that a microprocessor is there.

ROMs fall into different categories depending on their application and the volume of their manufacture. The particular chip considered here, a 2716, is selected based on its popularity and price. The 2716 is an erasable programmable read-only memory (EPROM) with 2K (2048 bytes) of memory. It may be programmed with simple circuitry and straightforward techniques.

To correct mistakes, or when you wish to replace an old program with a new one, the chip can be erased by exposure to ultraviolet light.* Program-

*Commercial UV erasers are available from computer hobbyist supply houses for \$65 to \$75. A simple home-built eraser is described by Golter, "Build a Low-Cost EPROM Eraser," *BYTE*, April, 1980.

By C.A. Eubanks, N3CA, P.O. Box 127, Valencia, Pennsylvania 16059

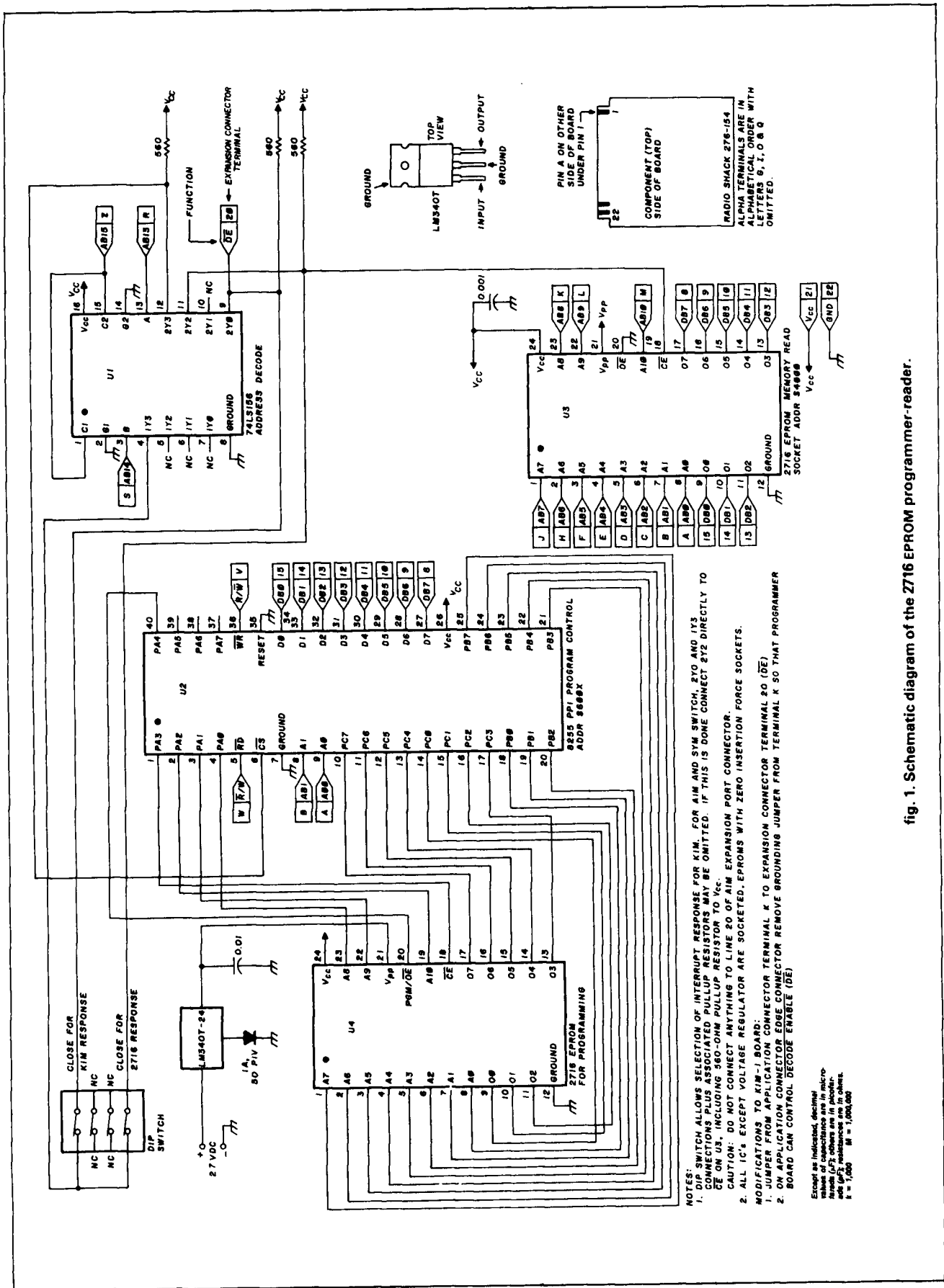

NOTES:

- DIP SWITCH ALLOWS SELECTION OF INTERRUPT RESPONSE FOR KIM-1 FOR AIM AND SYN SWITCH. 2Y0 AND 1Y3 CE AND 1Y2 AND 1Y1 CE PULLUP RESISTORS MAY BE OMITTED. IF THIS IS DONE CONNECT 2Y2 DIRECTLY TO Vcc. 1Y3 AND 1Y1, INCLUDING 300-ohm PULLUP RESISTOR TO Vcc.
- CAUTION: DO NOT CONNECT ANYTHING TO LINE 20 OF AIM EXPANSION PORT CONNECTOR.
- ALL ICs EXCEPT VOLTAGE REGULATOR ARE SOCKETED. EPROMS WITH ZERO INSERTION FORCE SOCKETS.

MODIFICATIONS TO KIM-1 BOARD:

- JUMPER FROM APPLICATION CONNECTOR TERMINAL K TO EXPANSION CONNECTOR TERMINAL 20 (DE)
- ON APPLICATION CONNECTOR EDGE CONNECTOR REMOVE GROUNDING JUMPER FROM TERMINAL K SO THAT PROGRAMMER BOARD CAN CONTROL DECODE ENABLE (DE)

Except as indicated, decimil
 resistors are 1/4W 5% tolerance
 resistors (A-F) values are in ohms.
 1K = 1,000 1M = 1,000,000

fig. 1. Schematic diagram of the Z716 EPROM programmer-reader.

ming can be accomplished a byte at a time, or the entire EPROM may be programmed at once. Unfortunately, during erasure, everything gets erased together.

how it works

The basic programming circuit is built around an 8255 programmable peripheral interface chip (PPI). The 8255, designed for compatibility with the 80XX line of microprocessors, is easy to interface and has sold in sufficient quantity to be economical for Amateur use. It can be addressed by the controlling microprocessor bus and directed to either read from or write to its input/output lines, providing communication with the EPROM being programmed.

The microprocessor board supplies the byte address of the location in the EPROM being programmed, the data to be recorded and the enabling signal. Programming all of the 2048 EPROM locations at one time requires about 103 seconds, or 50 milliseconds per location.

Programming a 2716 EPROM requires a 25-volt positive signal. This voltage is derived from a 24-volt LM340T monolithic regulator chip, as shown in fig. 1. A diode in the regulator's reference leg increases the output to approximately 25 volts. The chip is powered by three 9-volt transistor radio batteries connected in series. Though not elegant, the technique is quite effective for small volume use.

The microprocessor chips used in the KIM, AIM and SYM circuits have a pull-down-to-reset signal, which is not directly compatible with the 8255 chip (pull-up to reset). Rather than add an additional IC to provide the extra gate needed for hardware reset, I decided to do it with software. This is accomplished by converting all of its ports to inputs with a control instruction before connecting the batteries to the 24-volt regulator.

The programming algorithm includes a testing operation before programming to ensure that the EPROM area to be used is clean (all bits set to logical ones — the erased condition). The algorithm also contains a second comparison routine after programming to ensure that data transcription is correct. Fig. 2 is a flow chart showing the initial verification and programming. The final comparison uses similar technique.

I selected the addressing of the PPI and 2716 EPROM read socket to be compatible with the SYM, AIM, and KIM microprocessor boards. On the first two these addresses are mapped into the user expansion space. On the KIM they fall above the monitor.

Both the PPI and the EPROM read socket must be enabled; that is, told when to respond to address and data bus inputs. This is accomplished by applying a logical zero (low level) signal to the NOT chip enable

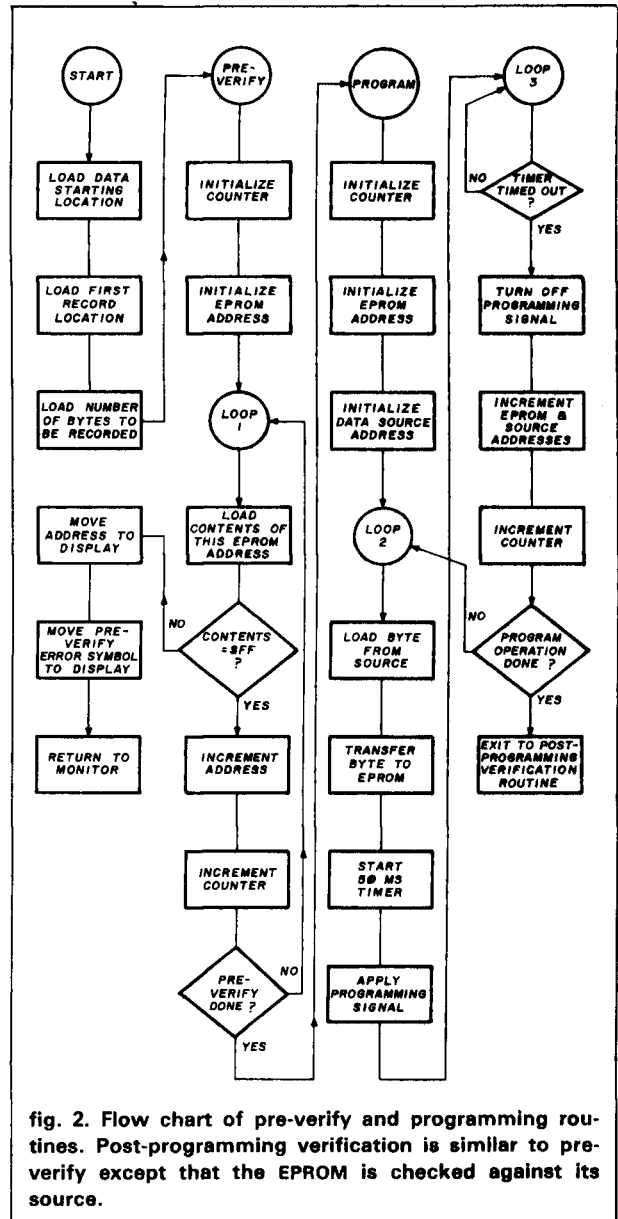

fig. 2. Flow chart of pre-verify and programming routines. Post-programming verification is similar to pre-verify except that the EPROM is checked against its source.

(\overline{CE}) line of the selected chip. A 74LS156 three-to-eight line open collector decoder performs this selection by address decoding. It breaks the 64K addressing capability of the microprocessor into eight 8K segments as shown in fig. 3. The NOT 8K segment 3 line ($\overline{8K3}$) is assigned to the PPI and the $\overline{8K2}$ line is assigned to the EPROM read socket.

Beyond this point the KIM differs from the SYM and the AIM. The latter two fully decode the portions of memory that they use internally, whereas the KIM does not have this feature. Without outside help it can't tell one 8K segment from another. The KIM's NOT decode enable (\overline{DE}) must be brought low only when its on-board devices are to respond to an address on the address bus. To permit this action the $\overline{8K0}$ and the $\overline{8K7}$ lines from the 74LS156 decoder are

wire-OR tied (paralleled — see fig. 3) together. The first of these picks up on-board KIM devices during normal addressing, and the latter allows interrupt responses.

This occurrence gives rise to an interesting opportunity for the KIM user. If the $\overline{8K7}$ line is instead wire-OR tied to the EPROM read socket, the resident EPROM will respond to interrupts. To permit this, a DIP switch is included on the board to control which device gets the $\overline{8K7}$ enabling signal. As mentioned above, this applies only to the KIM.

Note that if circuitry is set up for use with the KIM, it may be used on AIM and SYM systems with the following provisions:

1. The EPROM read socket must not be selected as the interrupt source. If it is, bus contention will result when both the host board and the EPROM try to respond to $\overline{8K7}$ addresses on read cycles.
2. Line 20 on the expansion connector must be left open with the AIM.

The AIM 65 uses this connection for other purposes. Alternatively, AIM and SYM users may omit the connections to the $\overline{8K0}$ and $\overline{8K7}$ lines, the associated resistors and the DIP switch.

You will notice that this is a fairly wasteful method of addressing. The PPI uses only four addresses out of the 8K available to it. The EPROM read socket uses only 2K of its 8K. I found no use for the additional possible PPI addresses, but the EPROM addresses are a different story. The price of 2732 EPROMs (4K byte

EPROMs) are today about half of what 2716s cost two years ago. I expect that before long I'll modify the programming board to handle 2732s and possibly 2764s. They are virtually identical to the 2716 and require minimal circuit changes

construction

The unit is assembled on a Radio Shack two-voltage edge-card board, part no. 276-154. I selected this board because it has an edge connector matching that found on the KIM, SYM, and AIM systems. Those with a different type of microprocessor system may choose alternative boards better suited to this application.

All ICs except the voltage regulator are socketed. The sockets make modifications easier and let you remove static-sensitive MOS chips when the board must be handled. For the EPROMs, zero insertion force (ZIF) sockets were selected to minimize wear and tear on the 2716 chips. The ZIF sockets are wide enough so that they overhang the outermost connections for each pin on the programmer board, which means that the wiring must be completed before installing the ZIF sockets. Advance planning in the wiring layout is necessary to keep it from obstructing ZIF socket installation.

A four-unit DIP switch was selected to control decoding for top-end-of-memory addressing. A conventional toggle switch could be substituted, but the DIP switch fits more neatly into the board layout. These switches are needed only if KIM compatibility is sought.

All wiring and components are located on the blank (non-foil) side of the board. Install short jumpers for V_{CC} and ground connections before wiring the longer runs.

Jumper cables with suitable connectors are available* to connect the boards together but they are considerably longer than my layout required and they're expensive. I obtained wire-wrap connectors at a hamfest and hand wired them together instead. I mounted the programmer board quite close to the microprocessor board to minimize reactance and crosstalk. The wiring between the connectors is 1-1/2 inches (4 cm) long. After wire wrapping the connectors I applied a liberal coat of silicone rubber sealer to keep repeated installations and removals from loosening the wraps.

The KIM expansion connector contains all the necessary lines except the \overline{DE} line. Fortunately, there are unused lines on the expansion connector, termi-

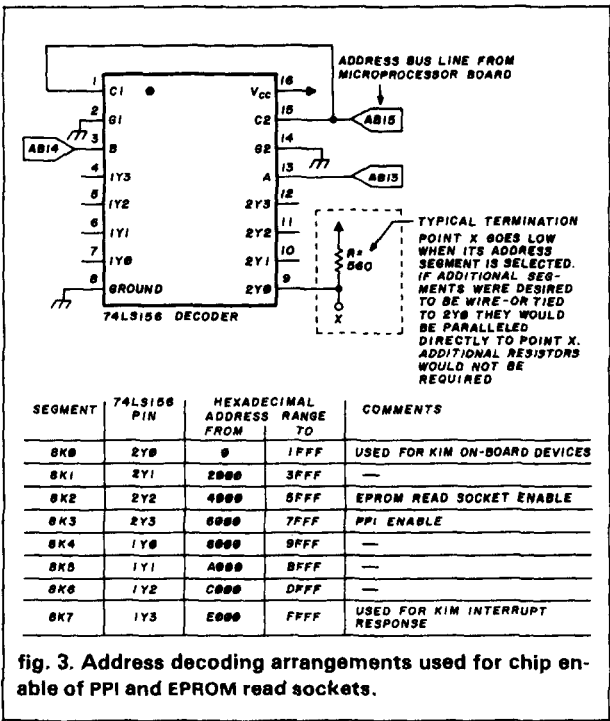

fig. 3. Address decoding arrangements used for chip enable of PPI and EPROM read sockets.

*Available from the Computerist, Inc., Post Office Box 3, South Chelmsford, Massachusetts 01824. Program documentation and programmed EPROMs are available from the author. Send an SASE for information.

nals 18, 19 and 20. I wired the DE line from the application connector's terminal K to terminal 20 on the expansion connector with an on-board jumper. No board changes are needed on the SYM or AIM.

The regulator chip probably doesn't need a heat-sink at the currents drawn during programming. If one is handy in the junk box, however, there's certainly nothing lost in installing it.

The batteries are connected using 9-volt battery connector leads. When not programming EPROMs the batteries should be disconnected and may be relegated to the refrigerator to prolong their life.

Both the jumper lead on the microprocessor board and the battery connector leads on the programmer board should be anchored with spots of silicone rubber sealant, which prevents placing mechanical stress on their solder joints.

notes on components

The basic cost of the parts for this board is about \$34, which includes the two ZIF sockets but does not include connectors or 2716 EPROMs. Comparable EPROM programming systems available commercially start around \$80. Many run in excess of \$200 wired, although the higher end boards usually have multiple EPROM read sockets and may perform other functions such as handling memory expansion as well.

The more exotic chips used here (the 2716s and the 8255) were picked up from mail-order suppliers. Most of these accept phone orders for credit-card billing and feature 48-hour order turn-around via UPS. A sample of five suppliers of 8255s from the July, 1981, issue of *BYTE* magazine shows a unit price range from \$5.40 to \$9.95.

initial operation

Check the wiring to make sure its correct and that no shorts or solder bridges exist before applying power. My original wiring was all right, but apparently I'm losing my color vision: one resistor was the wrong value.

With both EPROM sockets empty, connect the board to the microprocessor system's expansion connector (with the system de-energized, please!). Fire up the microprocessor and direct the 8255 PPI to output logical ones to each of the programming socket's pins, one at a time. Check operation with a voltmeter. Note that KIM and similar systems can't write to the PPI manually because the monitor tries to treat the PPI as a read/write memory. Things get snarled up with the monitor when it tries to read back what it's just written. To write to the PPI, a store absolute instruction (or its equivalent) must be used.

I've encountered only one hardware problem since

startup (my software is always full of bugs). During an EPROM read, one or more bit at one or more addresses would occasionally be wrong. To the best I've been able to determine, this was due to low power-supply voltage (about 4.75 volts on the EPROM board). I corrected this by installing a 0.001 μ F bypass at the read socket's V_{CC} pin and by cranking the power supply up to 4.98 volts under load.

Table 1 lists the rules for using the PPI to talk to the programming socket as they apply to this circuit. Carefully step through your algorithm before applying programming voltages to an EPROM, and make sure that the 50-millisecond period falls somewhere between 45 and 55 milliseconds. Periods under 45 milliseconds may give incorrect programming, and over 55 milliseconds may leave you a dead EPROM!

An additional consideration on the EPROM programming side is that the manufacturer's data sheet requires application of V_{CC} (+5 volts) before applying V_{PP} (+25 volts) and removing V_{PP} first (concurrent application and removal are also permitted). To avoid getting into trouble, don't connect the batteries until you are ready to program, and disconnect them just as soon as you are finished.

table 1. Rules for PPI programming.

function	PGM/ \overline{CE} port line PA3 (2716 Pin 18)	\overline{OE} port line PA4 (2716 Pin 20)	2716 response
program		1	program data in
program inhibit	0	1	high Z outputs
program verify	0	0	data out

8255 PPI control for this circuit

control addresses:

- \$6000 = port A
- \$6001 = port B
- \$6002 = port C
- \$6003 = control word register

control words:

- \$80 = make all ports outputs (for programming)
- \$9B = make all ports inputs (resets PPI and applies no signals to EPROM)
- \$89 = make ports A and B outputs; port C an input (for verify)

port assignments:

- port A = EPROM address lines A10 through A8 correspond to port lines PA2 through PA0, EPROM \overline{CE} to PA3, EPROM \overline{OE} to PA4
- port B = least-significant address byte
- port C = data bus

Once everything checks out, you're ready to go. Remember in use that the 8255 PPI and the 2716 are static-sensitive devices and may be ruined by improper handling. Follow manufacturer's recommendations and use an insulated insertion/extraction tool to handle the devices.

ham radio

Introducing the Universal Communication's DL-2000 Satellite TV Receiver

The LATEST in state-of-the-art TVRO Equipment

FEATURES:

- Built in modulator
- Built in Scan to aid in satellite tracking
- Built in metering
- True wide-band threshold extension
- Video polarity shift
- Variable sound tuning
- Active clamping circuit, true clamp not diode
- Switchable LNA power down coax
- Atmospheric tested down to -50°F
- Local oscillator leakage minimized by special mixer design
- Add-on remote control only \$38.50 extra

Accessories

LNAs: \$595 and up
Power Supplies
Feedhorns and Antennas

Price \$749.95 each
\$699.95 in lots of 10 or more

**UNIVERSAL
COMMUNICATIONS**

P.O. BOX 339
Arlington, TX 76004-0339

OUR PRODUCT MAY BE COPIED,
BUT THE PERFORMANCE IS NEVER EQUALLED.

(817) 860-1641



performance capability of active mixers

Part two: practical circuits and testing

In the first part of this article, I introduced the basic characteristics that distinguish active double-balanced mixers. The equations that define the significant interfering effects during signal handling were

Ed Oxner of Siliconix has designed several mixers based on the U257 transistor. The schematic is shown in fig. 11. Siliconix also made a version with four field-effect transistors in one package. Fig. 12 shows the schematic of such a configuration using the U350.

V MOS transistors have become popular, and a push-pull version with the VMP4 power FET, as described by Doug DeMaw, was shown in QST.⁴ (See fig. 13.)

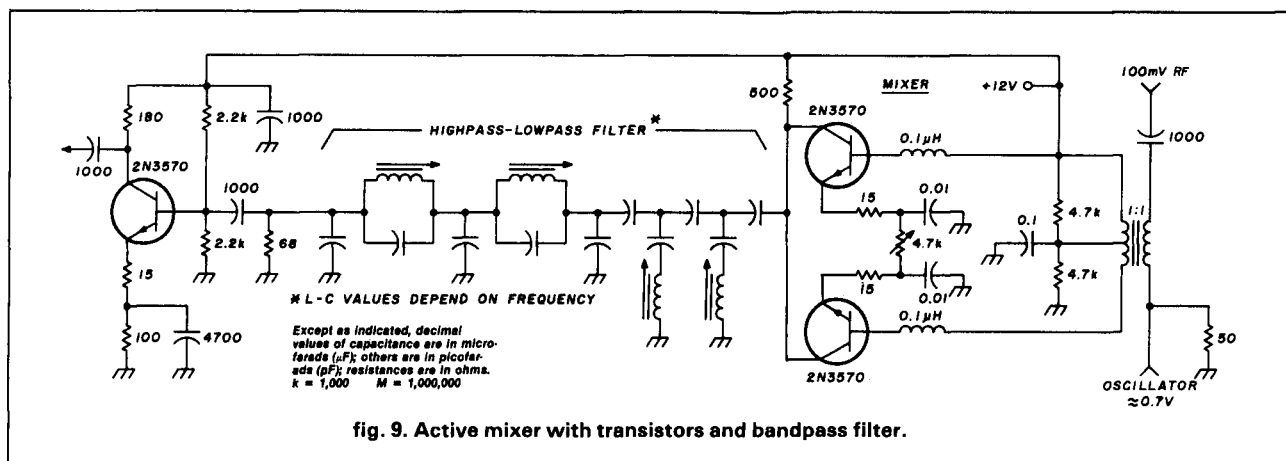

fig. 9. Active mixer with transistors and bandpass filter.

also developed. Now we will look at some practical mixer circuits and examine some testing techniques.

practical circuits

Because we are interested in the problems of balancing harmonics and other unwanted products, we will not consider simple, single-stage mixers but instead will look at several active mixer circuits that pretty much represent the state of the art. Depending on the bias to cutoff ratio of the devices selected, fairly high intercept points (up to +30 dBm) can be obtained.

Fig. 9 is the schematic of an active mixer using two VHF transistors in push-pull. Because of the number of spurious frequencies generated, substantial filtering at the output is recommended, as can be seen from the highpass-lowpass filter section. The two rf chokes at the base of each transistor prevent unwanted oscillation at fairly high frequencies.

Fig. 10 shows a balanced mixer using the 3N200 field-effect transistor in push-pull. This is a multiplicative mixer in which the rf input signal is fed in parallel.

Most loads into which the mixers operate do not present precisely 50 ohms to the mixer output. Also, most designers of active mixers have carefully avoided indicating the effects that occur in active mixers as the termination changes from a purely resistive 50-ohm load into some other value. In general, any change in resistive load that does not introduce reactive components does not affect the mixer substantially. A VSWR of 1:2 from 50 ohms, or change of load from 25 to 100 ohms resistive, does not have too many adverse effects. If, however, the mixer is terminated by an LC filter or crystal filter, the impedance changes and becomes reactive, and the intercept point changes drastically. In some cases with active mixers, I have observed instabilities even to the point where the mixer turned into a low frequency oscillator.

Three basic circuits are known to prevent change of impedance. Fig. 14 shows a recommended ar-

By Dr. Ulrich L. Rohde, DJ2LR, 52 Hillcrest Drive, Upper Saddle River, New Jersey 07458

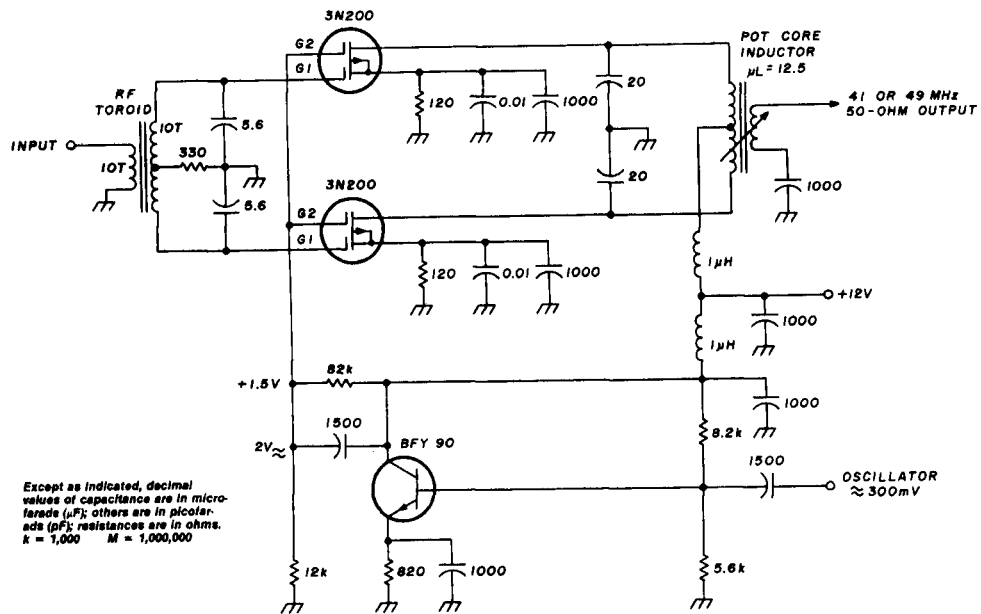

fig. 10. Push-pull mixer with 3N200 FETs.

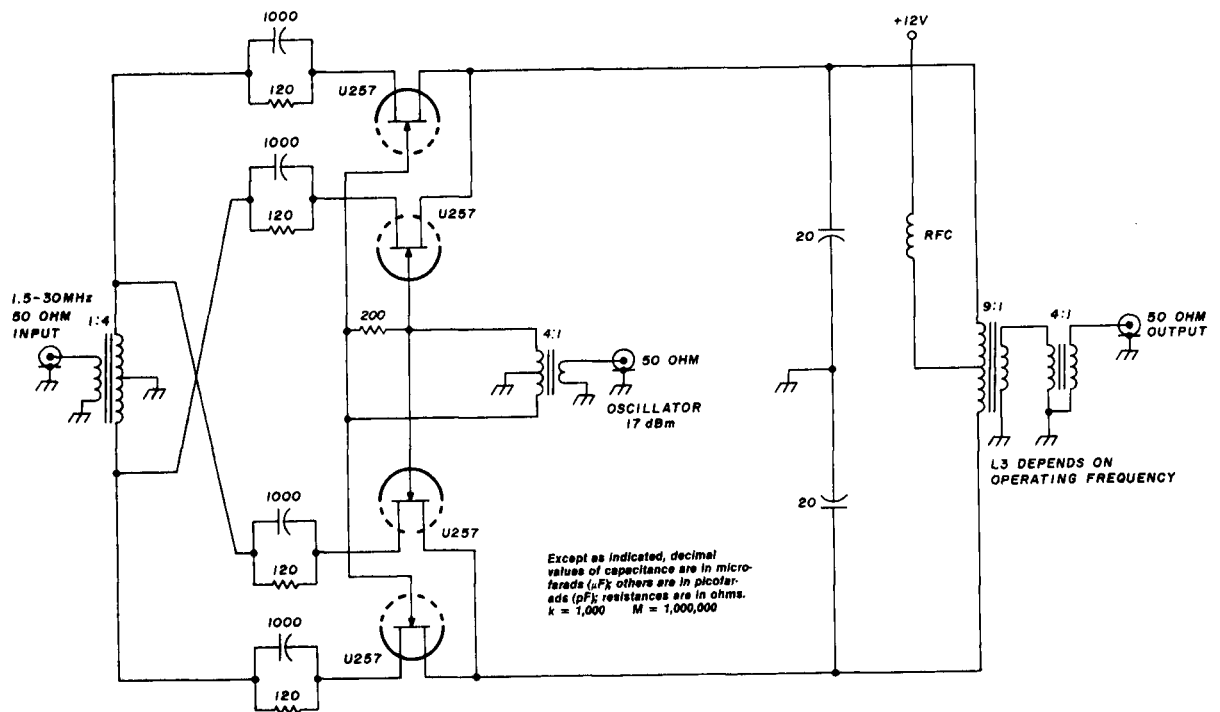

fig. 11. Double-balanced mixer with Siliconix U257.

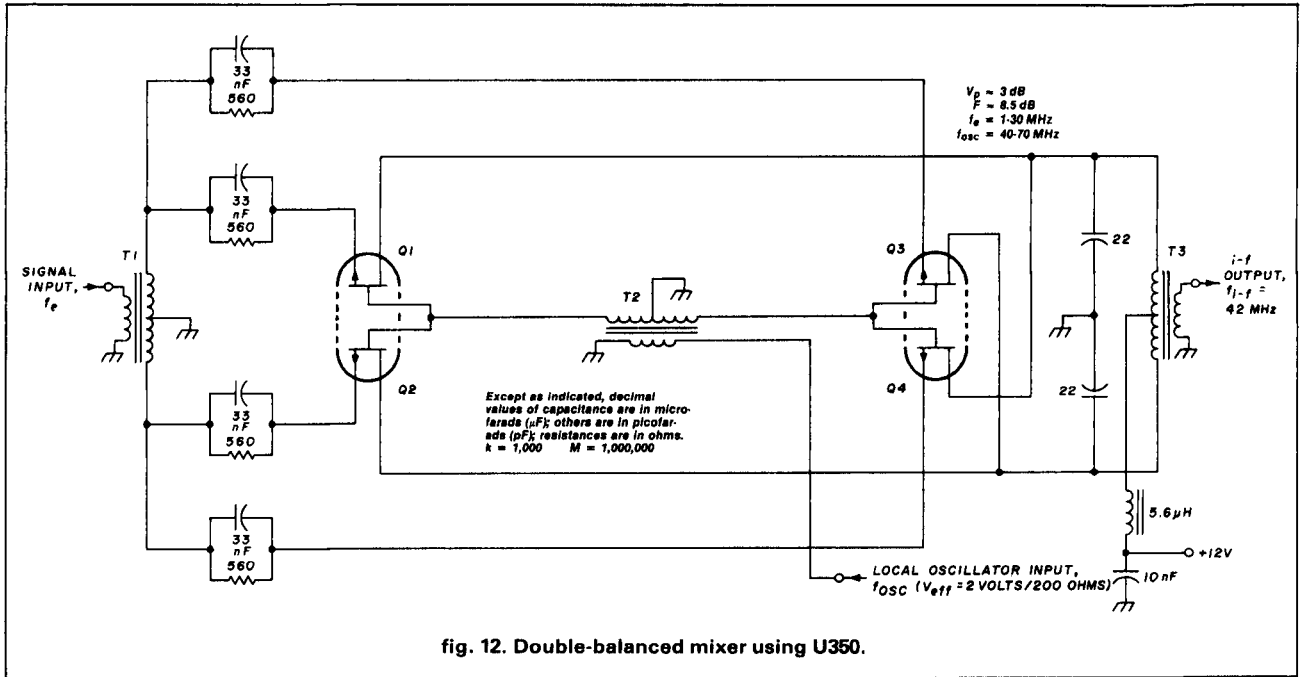

fig. 12. Double-balanced mixer using U350.

arrangement whereby the mixer, in this case a passive double-balanced mixer, is terminated by the input impedance of a grounded-gate field-effect transistor. It must be remembered that grounded-gate field-effect transistors properly biased exhibit purely resistive input over an extremely wide frequency range.

This holds true in most cases basically from dc to several hundred MHz. The CP643 or CP640 made by Teledyne Crystalonics is a good choice.

Another alternative is a feedback amplifier that uses noiseless feedback as described in the literature^{5,6} based on patent 3891934 of 1975. The third alternative is the use of a diplexer whereby the image at the output of the mixer is terminated with a 50-ohm resistor.

Probably the best solution is a combination of two transistors with a diplexer as shown in fig. 15. Again, for convenience, the circuit is shown with a passive balanced mixer together with this particular termination circuit.

Let's now take a look at some systems calculations that will yield a surprising result.

Active mixer with perfect termination. Consider an active mixer such as the Plessey SL6440 in any of the previously shown schematics. The noise figure under large-signal operation is around 11 dB for the Plessey device and 8 dB for a U257 mixer. Relative to the typical loss of 6 dB in a passive mixer, the zero-dB gain of an active mixer already represents gain; to be specific, 6-dB gain over the passive device. Let us assume further that the amplifier following uses noiseless feedback and its noise figure is 2 dB. As the mixer has unity gain, the noise figure at the input is equal to the noise figure of the second stage plus the noise figure of the mixer, and in the case of the Plessey mixer the resulting noise is 11.2 dB.

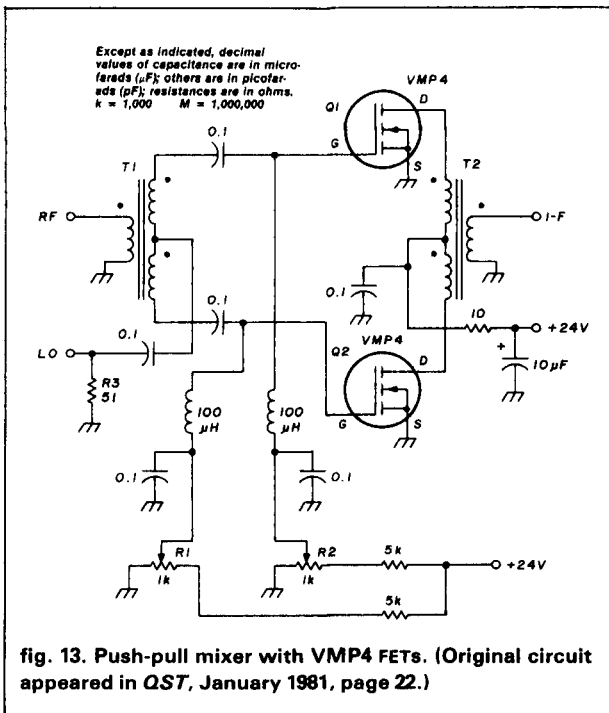

fig. 13. Push-pull mixer with VMP4 FETs. (Original circuit appeared in QST, January 1981, page 22.)

If we use a U257 stage, we get a 10-dB noise figure if we allow the same amount of gain. The intercept point is determined by the mixer and the second amplifier, and because of the special rf feedback applied in the second amplifier, we will, for the moment, assume that the second amplifier does not contribute any intermodulation distortion products. The very moment we operate the mixer with gain, we must take distortion of the second stage into consideration.

Passive double-balanced mixer with termination stage. Let's use the same example with a high-performance double-balanced mixer. The double-balanced mixer has an insertion loss of 6 dB, and the noise figure also is 6 dB.

The noise figure of the termination stage again is 2 dB, which results in a total systems noise figure of 8 dB, or 2 dB better than the previous example with the U257. Because of the 6-dB losses of the double-balanced mixer, the intermodulation distortion of the double-balanced mixer can be neglected, and the designer can concentrate on the mixer itself. This, I am sure, is a surprising result for most design engineers.

It is important to understand that the termination stage, when using the noiseless-feedback system, must also operate into a stable load. Any changes of the output load of such an rf feedback amplifier will be reflected into the input. A recommended way to reduce this change is to operate this stage at a higher than necessary gain; 3 or 4 dB is sufficient. A resistive pad with 3-dB attenuation will then prevent dramatic changes at the output.

In the case of the grounded-gate field-effect transistor as a termination, this circuit works reliably only if the drain-to-source feedback capacitor is kept extremely small and the capacitance is basically determined by the transistor itself.

If the output stage must operate into a crystal filter, we will find that most crystal filters outside the passband characteristic exhibit high impedance, which is either inductive or capacitive. This effect can be reduced by using a highpass filter at the output that incorporates the crystal filter. If the crystal filter's impedance increases, the highpass filter is mistuned, and the voltage at the drain or collector remains low. As a result, the third-order intermodulation distortion products remain low. In a conventional circuit, it is sometimes found that the sudden increase of impedance at the output of the transistor makes the intermodulation distortion deteriorate.

passive mixer with active devices

Recent developmental work in the field of mixers

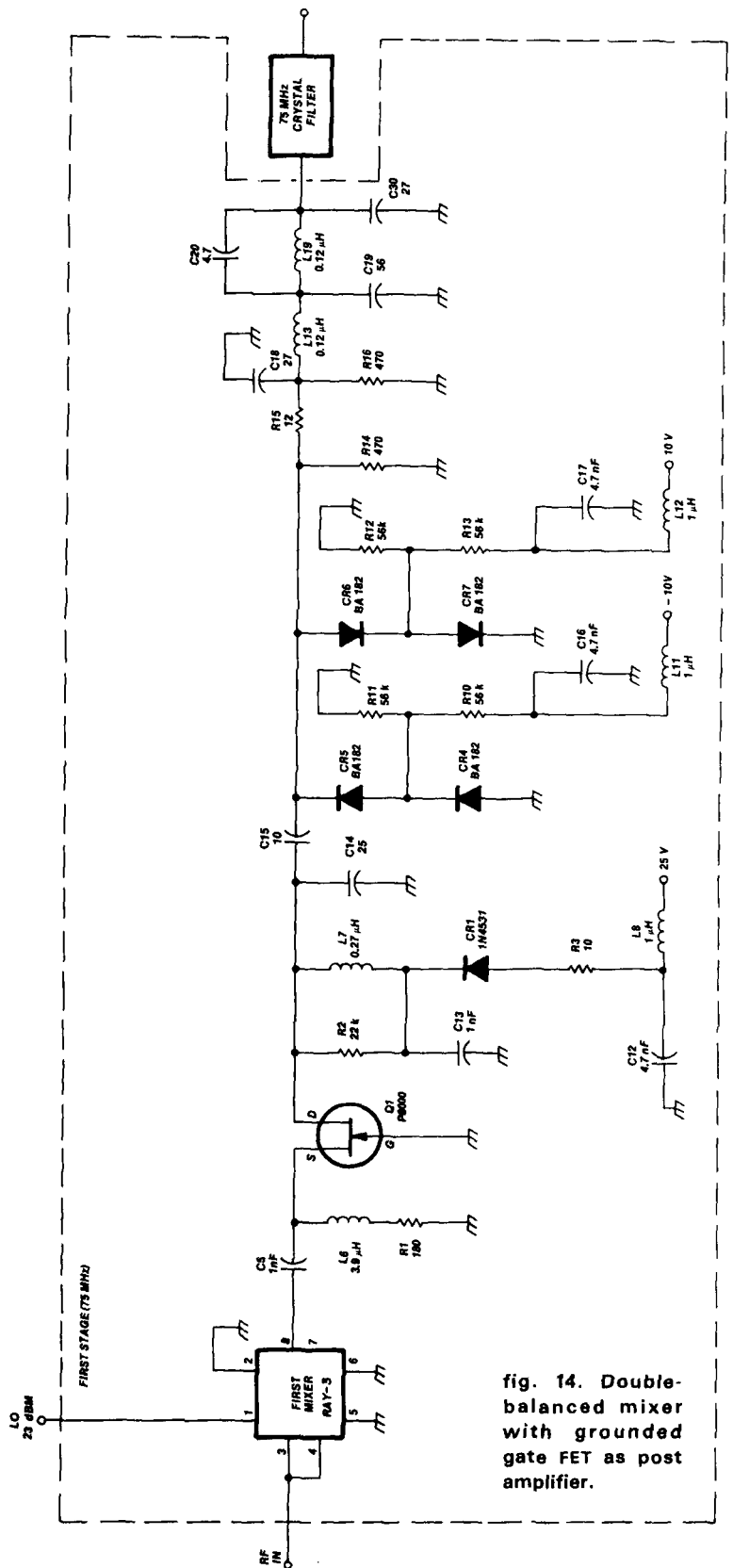

fig. 14. Double-balanced mixer with grounded gate FET as post amplifier.

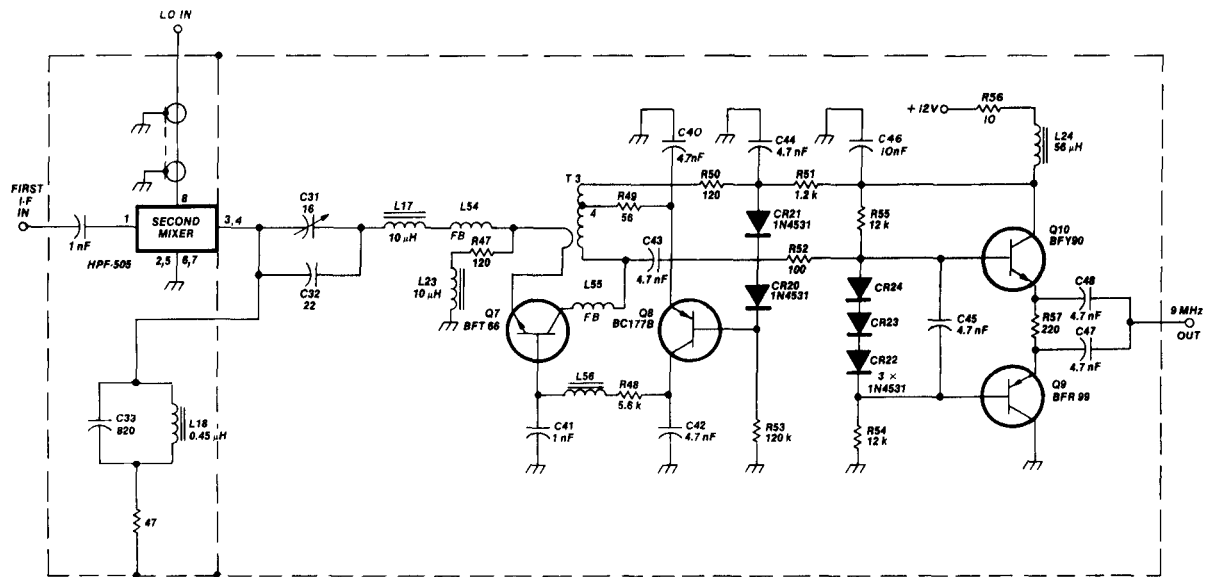

fig. 15. Double-balanced mixer with noiseless feedback amplifier as well as diplexer as termination.

indicates that the best way of achieving high intercept points in mixers is the use of:

1. Bipolar transistors as switches and with feedback.
2. Field-effect transistors as switches.

In ordinary applications, mixers using active devices operate on the nonlinear transfer characteristic, as explained earlier. Diode mixers are substantially better, because here the device is only switched on and off, and if the on-off resistance of the device has a high enough ratio, the device will be fast enough to follow the local-oscillator drive waveform. Enough local-oscillator drive power is available, theoretically, so that no harmonic distortion should occur. The losses would be 3 dB, as would the noise figure; thus we would not observe any intermodulation distortion products at all. Using active devices, we depend upon the nonlinearities of the input and output ports and, as with the field-effect transistor, possible distortion of the gate source diode and the potential nonlinearities of the channel resistance.

The state of the art for mixers using field-effect transistors without operating voltage and, therefore, only as switches, indicates approximately a +42 dBm input intercept point, 5.5 dB noise figure and insertion loss, and local-oscillator requirements of about +23 dBm. The local-oscillator drive requirement really results from the fact that a certain voltage has to be available at the gate electrode. In a quad configuration, this voltage can be as high as 50-volts PEP into the input capacitance of the transistor. The

step-up transformer helps reduce the required power.

Fig. 16 shows the schematic of such a recommended mixer which, for test purposes, has a tuned input. This circuit is based on a patent issued to Mr. William Squires in 1968, number 3383601. It can be reported that for 1-volt input signal or +13 dBm, the third-order intermodulation distortion products are at -83 dBm, or 100 dBm down. This would increase to an intercept point of +70 dBm but can only be achieved in a narrowband circuit. In a wideband configuration, only 40 to 42 dBm is obtainable. The isolation between oscillator and signal port is about 60 dB and provides about 40-dB isolation to the i-f signal.

The area of using passive mixers with active devices is fairly new. The only company that seems to have a commercial product is Lorch in New Jersey, and the latest prices I have seen for their mixer were \$600 or \$700.

I had built an active mixer based on feedback and switching, which was published in *ham radio*.⁷ This mixer with similar performance was used in the Rhode & Schwarz 400-watt transceiver in the Tornado warplane.

testing

To make proper tests on the mixers using signal generators, a hybrid coupler with at least 40 dB isolation between the two input ports and an attenuator are required. The test setup provided by DeMaw in *QST*⁴ and shown in fig. 17 is ideal for this. He used

two signal generators with outputs around 14 MHz and combined them. An attenuator drives the mixer under test (MUT), the local-oscillator signal is supplied by a VFO, and the output is then analyzed.

The 2N5109 amplifier shown may not be sufficient for extremely high intercept points, as this stage may no longer be transparent. For stability tests when using active mixers, it is recommended one have a reactive network at the output of the mixer for the sole purpose of checking mixer instability.

Rather than use expensive signal generators, two oscillators with extremely low harmonic content and

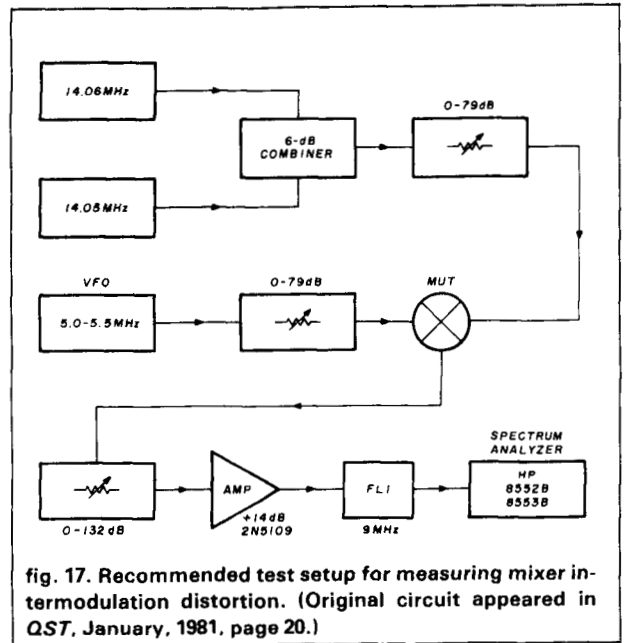

fig. 17. Recommended test setup for measuring mixer intermodulation distortion. (Original circuit appeared in QST, January, 1981, page 20.)

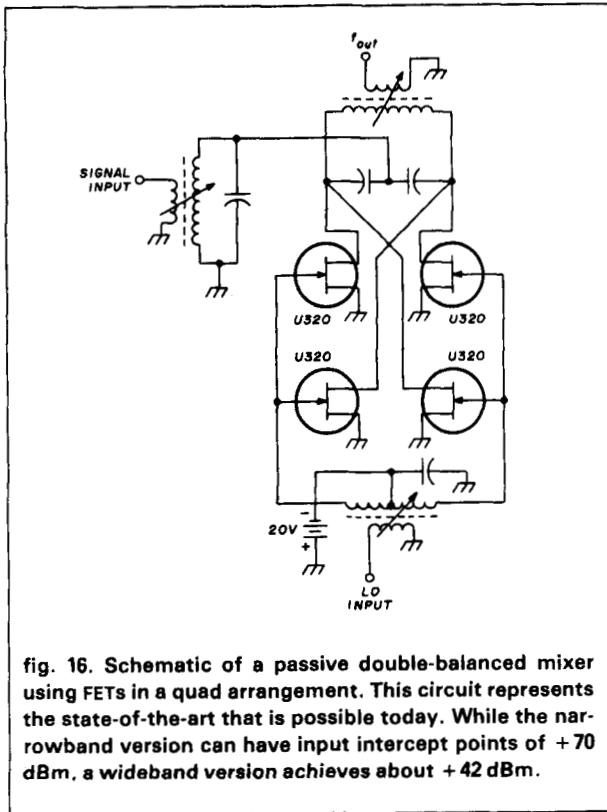

fig. 16. Schematic of a passive double-balanced mixer using FETs in a quad arrangement. This circuit represents the state-of-the-art that is possible today. While the narrowband version can have input intercept points of +70 dBm, a wideband version achieves about +42 dBm.

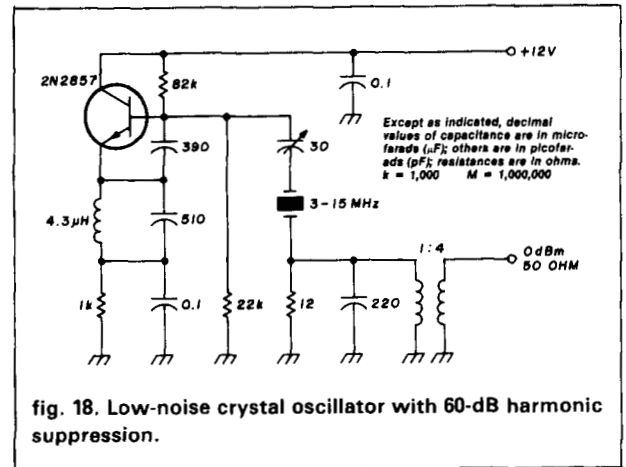

fig. 18. Low-noise crystal oscillator with 60-dB harmonic suppression.

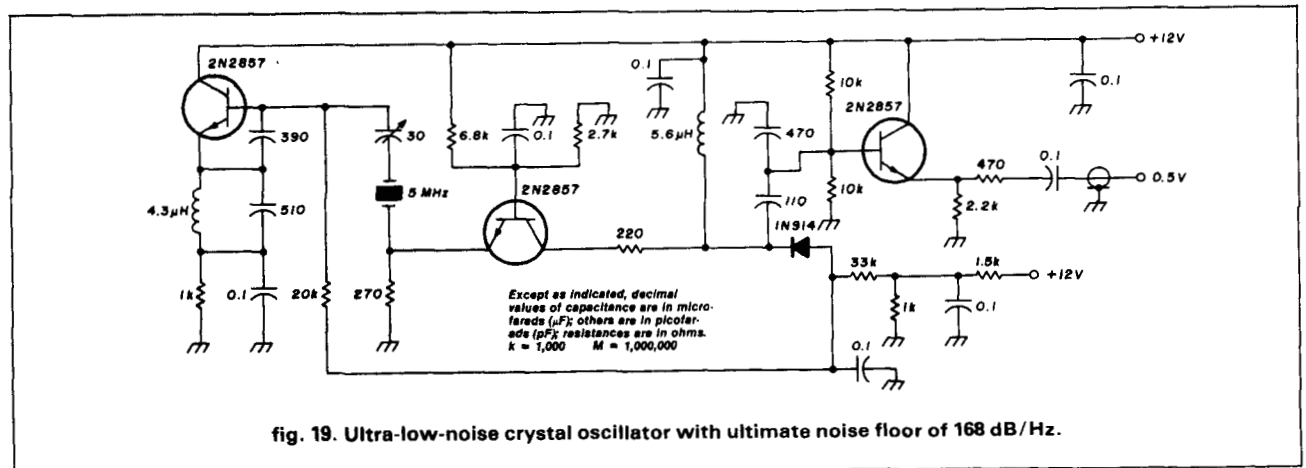

fig. 19. Ultra-low-noise crystal oscillator with ultimate noise floor of 168 dB/Hz.

very low noise sideband performance can be used. A convenient circuit to provide the required harmonic suppression and low noise is shown in **fig. 18**, based on an earlier paper of mine.⁸ For those interested in obtaining an additional 20-dB improvement in noise sidebands and need a test oscillator with this performance, the circuit in **fig. 19** is recommended. This oscillator shows an ultimate noise floor of 168 dB/Hz at 1 kHz off the carrier. As can be seen, this oscillator is a derivative of the earlier one. The input impedance of the grounded-base stage is about 2 ohms and, therefore, does not really deteriorate the Q of the crystal.

summary

I have explained that ordinary active mixers based on the inherent nonlinearities of their transfer characteristic by definition will show a lower intercept point than is possible with passive devices. Passive devices are already used with great success, and the termination-insensitive mixers, although they are not yet offered below 1 MHz, are currently the state of the art in diode mixers. By using feedback techniques together with switching-type active stages and bipolar transistors (or better yet, using modern power junction field-effect transistors), I have measured third-order and higher input intercept points to 40 dBm. In selective cases and narrowband frequency operation, +70 dBm intercepts have been reported. It is not likely that these figures will be useful, as the termination stages of following crystal filters or other devices will become the limiting factor.

I have just learned that Mini-Circuit Laboratories has introduced a new mixer, type VAY1, that claims a 38-dB intercept point at the input, which results in a 32-dBm intercept point at the output. However, the drive requirements are much higher than for the passive FET mixer.

references

4. Doug DeMaw and George Collins, "Modern Receiver Mixers for High Dynamic Range," *QST*, January, 1981, page 19.
5. Ulrich L. Rohde, DJ2LR, "Wideband Amplifier Summary," *ham radio*, November, 1979.
6. David Norton, "High Dynamic Range Transistor Amplifiers using Lossless Feedback," *Microwave Journal*, May, 1976.
7. Ulrich L. Rohde, DJ2LR, "High Dynamic Range Active Double Balanced Mixers," *ham radio*, November, 1977.
8. Ulrich L. Rohde, DJ2LR, "Crystal Oscillator Provides Low Noise," *Electronic Design*, October 11, 1975.

bibliography

- Oxner, Ed, "FETs in Balanced Mixers," *Siliconix Application Note AN72-1*.
 Oxner, Ed, "Junction FETs in Active Double Balanced Mixers," *Siliconix Application Note AN73-4*.
 Vogel, J.S., "Nonlinear Distortion and Mixing Processes in FETs," *Proceedings of the IEEE*, December, 1967, pages 2109-116.
 Will, Peter, "Reactive Loads — The Big Mixer Menace," *Microwaves*, April, 1971, pages 38-42.

ham radio

NOW!

HAL Communications Is Proud To Announce That Our Amateur Radio Products Are Being Stocked At The Following Leading Amateur Dealer Stores:

EASTERN UNITED STATES:

AMATEUR ELECTRONICS SUPPLY
 28940 Euclid Ave.
 Wickliffe, OH 44092
 (216) 585-7388

ELECTRONICS INTERNATIONAL SERVICE CORP.
 11305 Elkin Street
 Wheaton, MD 20902
 (301) 946-1088

MIDWEST UNITED STATES:

AMATEUR ELECTRONICS SUPPLY
 4828 W. Fond du Lac Ave.
 Milwaukee, WI 53216
 (414) 442-4200

DIALTA AMATEUR RADIO SUPPLY
 212 - 48th Street
 Rapid City, SD 57701
 (605) 343-6127

ERICKSON COMMUNICATIONS
 5456 N. Milwaukee Avenue
 Chicago, IL 60630
 (312) 631-5181

HAM RADIO CENTER
 8340-42 Olive Blvd.
 St. Louis, MO 63132
 (314) 993-6060

THE HAM SHACK
 808 N. Main St.
 Evansville, IN 47711
 (812) 422-0231

UNIVERSAL AMATEUR RADIO
 1280 Aida Drive
 Reynoldsburg, OH 43068
 (614) 866-4267

WESTERN UNITED STATES:

AMATEUR ELECTRONICS SUPPLY
 1072 N. Rancho Drive
 Las Vegas, NV 89106
 (702) 647-3114

CW ELECTRONICS
 800 Lincoln Street
 Denver, CO 80203
 (303) 832-1111

HENRY RADIO, INC.
 2050 S. Bundy Dr.
 Los Angeles, CA 90025
 (213) 820-1234

SOUTHERN UNITED STATES:

ACK RADIO SUPPLY COMPANY
 3101 4th Ave. South
 Birmingham, AL 35233
 (205) 322-0588

AGL ELECTRONICS
 13929 N. Central Expwy
 Suite 419
 Dallas, TX 75243
 (214) 699-1081

AMATEUR ELECTRONIC SUPPLY
 621 Commonwealth Ave.
 Orlando, FL 32803
 (305) 894-3238

AMATEUR ELECTRONIC SUPPLY
 1898 Drew Street
 Clearwater, FL 33515
 (813) 461-4267

AMATEUR RADIO CENTER
 2805 N.E. 2nd Ave.
 Miami, FL 33137
 (305) 573-8383

BRITT'S TWO-WAY RADIO
 2508 N. Atlanta Rd.
 Belmont Hills
 Shopping Center
 Smyrna, GA 30080
 (404) 432-8006

GISMO COMMUNICATIONS
 1039 Latham Drive
 Rock Hill, SC 29730
 (803) 366-7157

MADISON ELECTRONICS
 1508 McKinney Ave.
 Houston, TX 77010
 (713) 658-0268

N & G DISTRIBUTING CORP.
 7201 N.W. 12th Street
 Miami, FL 33126
 (305) 592-9685

RAY'S AMATEUR RADIO
 1590 US Highway 19 South
 Clearwater, FL 33516
 (813) 535-1414

Call Or Stop-In And See HAL Equipment At Your Favorite Amateur Dealer.

Write today for HAL's latest RTTY catalog



HAL COMMUNICATIONS CORP.

Box 365
 Urbana, Illinois 61801
 217-367-7373

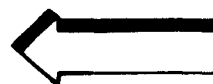

CT2100

HAL Puts MORE Behind The Buttons

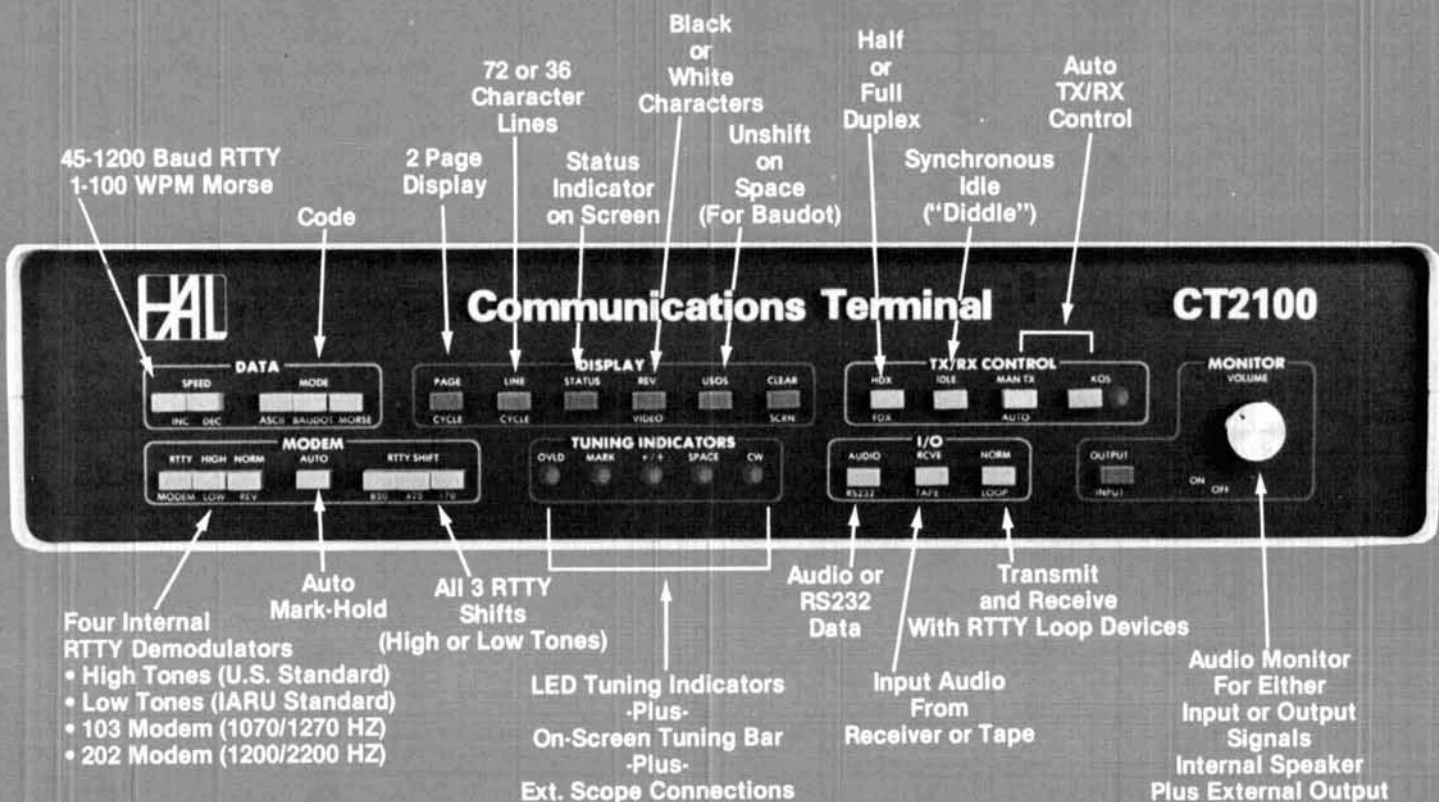

CT2100 System:

- CT2100 Communications Terminal
- KB2100 Keyboard
- Video Monitor
- Printer (300Bd Serial ASCII-MPI-88G)
- RM2100 Rack Adapter
- MSG2100 2000 Character "Brag Tape" ROM

- 24 Line Display
- 2 Pages of 72 Character Lines
- or-
- 4 Pages of 36 Character Lines
- Split Screen (with KB2100)



HAL COMMUNICATIONS CORP.
Box 365
Urbana, Illinois 61801
217-367-7373

**NOW! HAL Equipment is
in stock at leading Amateur
Dealers.**

Introducing incredible tuning accuracy at an incredibly affordable price: The Command Series RF-3100

31-band AM/FM/SW receiver.* No other shortwave receiver brings in PLL quartz synthesized tuning and all-band digital readout for as low a price.† The tuner tracks and "locks" onto your signal, and the 5-digit display shows exactly what frequency you're on.

There are other ways the RF-3100 commands the airways: It can travel the full length of the shortwave band (that's 1.6 to 30 MHz). It eliminates interference when stations overlap by narrowing the broadcast band. It improves reception in strong signal areas with RF Gain Control. And the RF-3100 catches Morse

communications accurately with BFO Pitch Control.

Want to bring in your favorite programs without lifting a finger? Then consider the Panasonic RF-6300 8-band AM/FM/SW receiver (1.6 to 30 MHz) has microcomputerized preset pushbutton tuning, for programming 12 different broadcasts, or the same broadcast 12 days in a row. Automatically. It even has a quartz alarm clock that turns the radio on and off to play your favorite broadcasts.

The Command Series RF-3100 and RF-6300. Two more ways to roam the globe at the speed of sound. Only from Panasonic.

*Shortwave reception will vary with antenna, weather conditions, operator's geographic location and other factors. An outside antenna may be required for maximum shortwave reception.

†Based on a comparison of suggested retail prices.



This Panasonic Command Series™ shortwave receiver brings the state of the art closer to the state of your pocketbook.



With PLL Quartz Synthesized Tuning and Digital Frequency Readout.

Panasonic
just slightly ahead of our time.

336 PAGES BIG

The Gunnplexer Cookbook

by **Robert M. Richardson, W4UCH/2**

Ever wanted to take a good look at 10 GHz operation? Well, here's your chance. Starting with the basic theory of the Microwave Associate's Gunnplexer transceiver, author Richardson describes in 16 building-block chapters, how to put a functioning Gunnplexer system into operation.

Chapters include: Frequency and Power Measurements, Power Supplies, Proportional Temperature Control, I-f Amplifiers, Antennas, Television and Computer Data Links and more.

The Gunnplexer Cookbook has been written for the Radio Amateur or electronic student who has at least modest experience assembling vhf converter or receiver kits. Only very basic test equipment is required.

You've waited a long time for this book. Don't wait any longer. Order your copy today!
© 1981 Softbound HR-GP \$9.95 plus \$1.00 for shipping.

Ham Radio Publishing Group
Greenville, New Hampshire 03048

MOVING? KEEP HAM RADIO COMING...

If possible let us know four to six weeks before you move and we will make sure your HAM RADIO Magazine arrives on schedule. Just remove the mailing label from this magazine and affix below. Then complete your new address (or any other corrections) in the space provided and we'll take care of the rest.

ham radio
Magazine

Allow 4-6 weeks for correction.

Greenville, NH 03048

Thanks for helping us to serve you better.

Here's my new address:

Call _____
Name _____
Address _____
City _____ State _____ Zip _____

AFFIX LABEL HERE

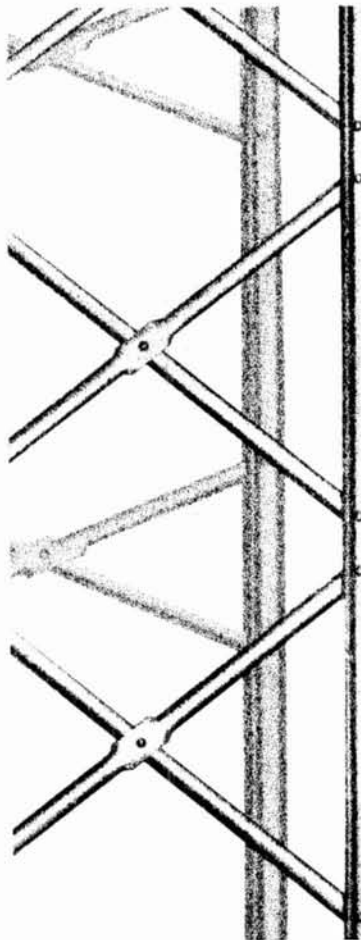

Rohn 'BX' TOWERS

- For Home TV, Ham Radio and CB.
- Up to 18 sq. ft. antenna capacity.
- Available to 64' in 8' sections.
- All riveted construction — no welds.
- Beaded channel leg for added strength.
- All steel — galvanized for added life.
- Can be used with Concrete Base Stubs, Cylinder Base or Hinged Concrete Base.

UNR-Rohn

Division of UNR Industries, Inc.
6718 West Plank Road, P.O. Box 2000
Peoria, Illinois 61656
U.S.A.

NEW

Small talk.



Processor, IF shift, N/W switch, affordable

TS-130SE

An incredibly compact, full-featured, reasonably priced, all solid-state HF SSB/CW transceiver for both mobile and fixed operation. It covers 3.5 to 29.7 MHz (including the three new Amateur bands) and features digital display, IF shift, speech processor, and narrow/wide filter selection on both SSB and CW.

TS-130SE FEATURES:

- **80-10 meters, including three new bands**
Covers all Amateur bands from 3.5 to 29.7 MHz, including the new 10, 18, and 24-MHz bands. Receives WWV on 10 MHz. VFO covers more than 50 kHz above and below each 500-kHz band.
- **Two power versions...easy operation**
TS-130SE runs 200 W PEP/160 W DC on 80-15 meters, and 160 W PEP/140 W DC on 12 and 10 meters. TS-130V runs 25 W PEP/20 W DC input on all bands. Solid-state, wideband final amplifier eliminates transmitter tuning; receiver wideband RF amplifiers eliminate preselector peaking.
- **Digital display built-in**
Six-digit green fluorescent tube display indicates operating frequency to 100 Hz, external VFO or fixed-channel frequency, RIT shift, and CW transmit-receive shifts. Analog subdial back-up.
- **Built-in Speech Processor**
Increases audio punch and average SSB output power.

Matching accessories for fixed station operation:

- PS-30 base station power supply (remotely switchable ON or OFF with TS-130SE power switch).

Other accessories not shown:

- FA-4 fan unit for TS-130SE
- YK-88C (500 Hz) and YK-88CN (270 Hz) CW filters
- YK-88SN (1.8 kHz) narrow SSB filter
- AT-130 compact antenna tuner (80-10 meters, including 3 new bands)
- MB-100 mobile mounting brackets
- KPS-21 base station power supply (also for TS-130SE)
- TL-922A linear amplifier
- SP-120 external speaker
- VFO-120 remote VFO
- MC-50 50k Ω /500 Ω desk microphone
- PS-20 base-station power supply for TS-130V
- PC-1 phone patch
- HC-10 world digital clock
- MC-30S and MC-35S noise cancelling hand microphones
- MC-60 deluxe desk microphone
- SP-40 compact mobile speaker
- HS-4, HS-5, and HS-6 headphones

• IF shift circuit

Very effective in eliminating interfering signals, by placing them outside the IF passband.

• CW narrow/wide selection

"N-W" switch allows selection of wide or narrow bandwidths. Wide CW and SSB bandwidths are the same. Optional YK-88C (500 Hz) or YK-88CN (270 Hz) filter may be installed for narrow CW.

• SSB narrow selection

"N-W" switch allows selection of narrow SSB bandwidth to eliminate QRM, when optional YK-88SN (1.8 kHz) filter is installed. (CW filter may still be selected in CW mode.)

• Sideband mode selected automatically

LSB on 40 meters and below; USB on 30 meters and above. SSB REVERSE position on MODE switch.

• RF Attenuator, built-in

Allows optimum rejection of IM distortion.

• Single conversion PLL system

Provides improved stability and spurious characteristics.

• Protection circuit for final amplifier.

For maximum reliability, the final amplifier is protected by circuitry that monitors VSWR and temperature. (TS-130V, VSWR only.) Output power is reduced when abnormal operating conditions occur. If especially severe operation is anticipated, optional cooling fan, model FA-4, may be added. Model TS-130S, with FA-4 installed, is also available.

• Effective noise blanker

Eliminates pulse-type noise.

• Compact and lightweight

Only 3-3/4 H x 9-1/2 W x 11-9/16 D (inches); weight 12.3 lbs.

• Other important features include:

VOX for SSB, CW semi break-in with sidetone, one fixed channel, and 25 kHz marker.



Optional DFC-230 Digital Frequency Controller

Allows frequency control in 20-Hz steps with UP/DOWN microphone (supplied with DFC-230). Includes four memories (handy for split-frequency operation) and digital display. Covers 100 kHz above and below each 500-kHz band. Very compact.

More information on the TS-130 Series is available from all authorized dealers of Trio-Kenwood Communications 1111 West Walnut Street Compton, California 90220.



Specifications and prices are subject to change without notice or obligation.



KENWOOD

...pacesetter in amateur radio

\$ CASH NOW! \$

ASK YOUR DEALER FOR DETAILS



TR-7730
\$30.00 OFF
WITH OR WITHOUT
MC-46



TS-530S
\$15.00 OFF



TR-8400
\$30.00 OFF



R-1000
\$30.00 OFF



TS-130SE or
TS-130S
\$15.00 OFF

Participating Trio-Kenwood Authorized Dealers:

ALABAMA

Long's Electronics
Birmingham, AL 35233
(205) 252-7589

ALASKA

Reliable Electronics
Anchorage, AK 99503
(907) 279-5100

ARIZONA

Power Communications
Phoenix, AZ 85015
(602) 241-9288

CALIFORNIA

Ham Radio Outlet
Burlingame, CA 94010
(415) 342-5757

Ham Radio Outlet
San Diego, CA 92123
(714) 560-4900

Ham Radio Outlet
Van Nuys, CA 91401
(213) 988-2212

Ham Radio Outlet*
Oakland, CA 94609
(415) 451-5757

Ham Radio Outlet
Anaheim, CA 92801
(714) 761-3033

Henry Radio, Inc.
Los Angeles, CA 90025
(213) 820-1234

Henry Radio & Electronics
Anaheim, CA 92801
(714) 772-9200

COLORADO
CW Electronic Sales Co.
Denver, CO 80202
(303) 832-1111

FLORIDA

Amateur Electronic Supply
Orlando, FL 32803
(305) 894-3238

Amateur Radio Center
Miami, FL 33137
(305) 573-8383

HAWAII

Honolulu Electronics
Honolulu, HI 96814
(808) 949-5564

IDAHO

Ross Distributing Co.
Preston, ID 83263
(208) 852-0830

ILLINOIS

Erickson Communications
Chicago, IL 60630
(312) 631-5181

INDIANA

Graham Electronics
Indianapolis, IN 46204
(317) 635-5453

Hoosier Electronics
Terre Haute, IN 47802
(812) 238-1456

Kryder Electronics
Fort Wayne, IN 46815
(219) 485-6434

IOWA

Hi, Incorporated
Council Bluffs, IA 51502
(712) 323-0142

KANSAS

Associated Radio Comm.
Overland Park, KS 66204
(913) 381-5901

MARYLAND

Electronic Int'l Service
Wheaton, MD 20902
(301) 946-1088

The Comm. Center
Laurel, MD 20810
(301) 792-0600

MICHIGAN

Radio Supply & Engineering
Detroit, MI 48201
(313) 435-5660

MINNESOTA

Midwest Amateur Radio Supply, Inc.*
Minneapolis, MN 55142
(612) 521-4662

MISSOURI

Ham Radio Center
St. Louis, MO 63132
(314) 993-6060

Henry Radio Company
Butler, MO 64730
(816) 679-3127

MidCom Electronics
St. Louis, MO 63144
(314) 961-9990

Missouri Radio Center*
Kansas City, MO 64150
(816) 741-8118

MONTANA

Conley Radio Supply
Billings, MT 59101
(406) 259-9554

NEBRASKA

Communications Center
Lincoln, NB 68508
(402) 476-7331

NEVADA

Amateur Electronic Supply*
Las Vegas, NV 89106
(702) 647-3114

NEW HAMPSHIRE

Tuff's Radio & Elect. Supply
Hudson, NH 03051
(603) 883-5005

NEW MEXICO

Electronic Module
Hobbs, NM 88240
(505) 397-3022

NEW YORK

Adirondack Radio Supply
Amsterdam, NY 12010
(518) 842-8350

Harrison Radio Corp.
Long Island, NY 11735
(516) 293-7990

Radio World

Oriskany, NY 13424
(315) 736-0184

OHIO

Amateur Electronic Supply
Wickliffe, OH 44092
(216) 585-7388

Sreppo Electronics
Dayton, OH 45404
(513) 224-0871

Universal Amateur Radio, Inc.

Reynoldsburg, OH 43068
(614) 866-4267

OKLAHOMA

Derrick Electronics*
Broken Arrow, OK 74012
(918) 251-9923

Radio, Inc.

Tulsa, OK 74119
(918) 587-9123

OREGON

Portland Radio Supply
Portland, OR 97205
(503) 228-8647

PENNSYLVANIA

Hamtronics/Trevose
Trevose, PA 19047
(215) 357-1400

J.R.S. Distributors
York, PA 17404
(717) 854-8624

SOUTH CAROLINA

G.I.S.M.O. Communications

Rockhill, SC 29730
(803) 366-7157

SOUTH DAKOTA

Burghardt Amateur Radio Center
Watertown, SD 57201
(605) 866-7314

TENNESSEE

Amateur Radio Supply of Nashville
Madison, TN 37115
(615) 868-4956

Memphis Amateur Electronics
Memphis, TN 38108
(901) 683-9125

TEXAS

Douglas Electronics
Corpus Christi, TX 78404
(512) 883-5103

Electronics Center

Dallas, TX 75201
(214) 526-2023

Hardin Electronics

Ft. Worth, TX 76112
(817) 429-9761

Madison Electronics

Houston, TX 77010
(713) 658-0268

Kennedy Associates

San Antonio, TX 78222
(512) 333-6110

WASHINGTON

A-B-C Communications
Seattle, WA 98155
(206) 364-8300

Amateur Radio Supply Co.

Seattle, WA 98108
(206) 767-3222

C-COMM*

Seattle, WA 98107
(206) 784-7337

WISCONSIN

Amateur Electronic Supply
Milwaukee, WI 53216
(414) 442-4200

*Interim Dealers



BONUS BUCKS

This KENWOOD BONUS BUCKS coupon, when presented to any factory authorized dealer in TRIO-KENWOOD COMMUNICATIONS products, may be used as partial payment in the amount of \$30.00 toward the purchase of any new KENWOOD model R-1000, TR-8400, or TR-7730 with MC-46 or basic UP/DOWN microphone, or may be used as partial payment in the amount of \$15.00 toward the purchase of any new KENWOOD model TS-130S, TS-130SE, or TS-530S amateur radio product. The purchase must be made during the period March 1, through June 15, 1982. The customer must present a separate coupon (one only) for each of the listed models being purchased. Additional coupons are available from our authorized dealers. TRIO-KENWOOD assumes no responsibility for the inability of any of its dealers or of itself to deliver any specific product within the period specified in the foregoing. Offer valid only in the U.S.A. Void where taxed or prohibited by law. Resellers are not eligible to participate in this program. This coupon is a part of TRIO-KENWOOD COMMUNICATIONS "BONUS BUCKS" sales program. It has no value unless submitted in compliance with the rules of that program prior to June 15, 1982.

		/ /1982	
Model Purchased		Date Purchased	
Dealer Name: _____			
Customer Name: _____		Call Sign: _____	
Address: _____			
City: _____		State/Zip: _____	
Customer Signature: _____			

Good Mar. 1 through Jun. 15, 1982.



KENWOOD

TRIO-KENWOOD COMMUNICATIONS
1111 West Walnut, Compton, California 90220

the weekender



words-per-minute readout for the deluxe memory keyer

After having constructed several "Accu-Keyers,"¹ and the "Deluxe Memory Keyer,"² I found that the one thing missing in both was the ability to tell exactly how fast I was sending. I thought there must be a simple way to add this convenience to these superb keyers. Most of the hardware to accomplish this is already mounted in the keyers: the clock pulses, counters, and the drivers with the readouts. The only missing part for the frequency counter are the timing gates, a time base and the readout latches.

words per minute versus frequency

The handbook states that 24 WPM equals 10 dots per second times 2.4. To put it in another way, 24 WPM equals 24 dots per 2.4 seconds. It takes two clock pulses to equal one dot (1 dit and 1 space), so 24 WPM equals 48 clock bits per 2.4 seconds, or 24 clock bits in 1.2 seconds. All we have to do now is to let the counters tally the clock bits for 1.2 seconds, put in two 7475 latches to hold this count and display it on the readouts, and we have our WPM counter. On my first attempt at building a speed readout, I

used a 3.58-MHz TV crystal and a 5369 oscillator chip for the 60-Hz time base and a multipole rotary switch to change modes. But then I decided a less expensive approach would be to use the 60 Hz from the secondary of the power transformer and two more 7400 chips to do the switching instead of the more expensive rotary switch. Thus evolved the circuit described here.

theory of operation

Refer to fig.1. In the WPM mode, the DPDT switch



View of the speed adapter board mounted on top of the driver board. The existing keyer memory board is under the driver board. The bit count, WPM mode switch is mounted in the upper left corner, rear, next to the speaker. (Photo courtesy of Bill Mansfield, W1MLT.)

By **Vernon W. Smith, WA10EH**, Box 75,
E. Thompson Rd., Thompson, Connecticut
06277

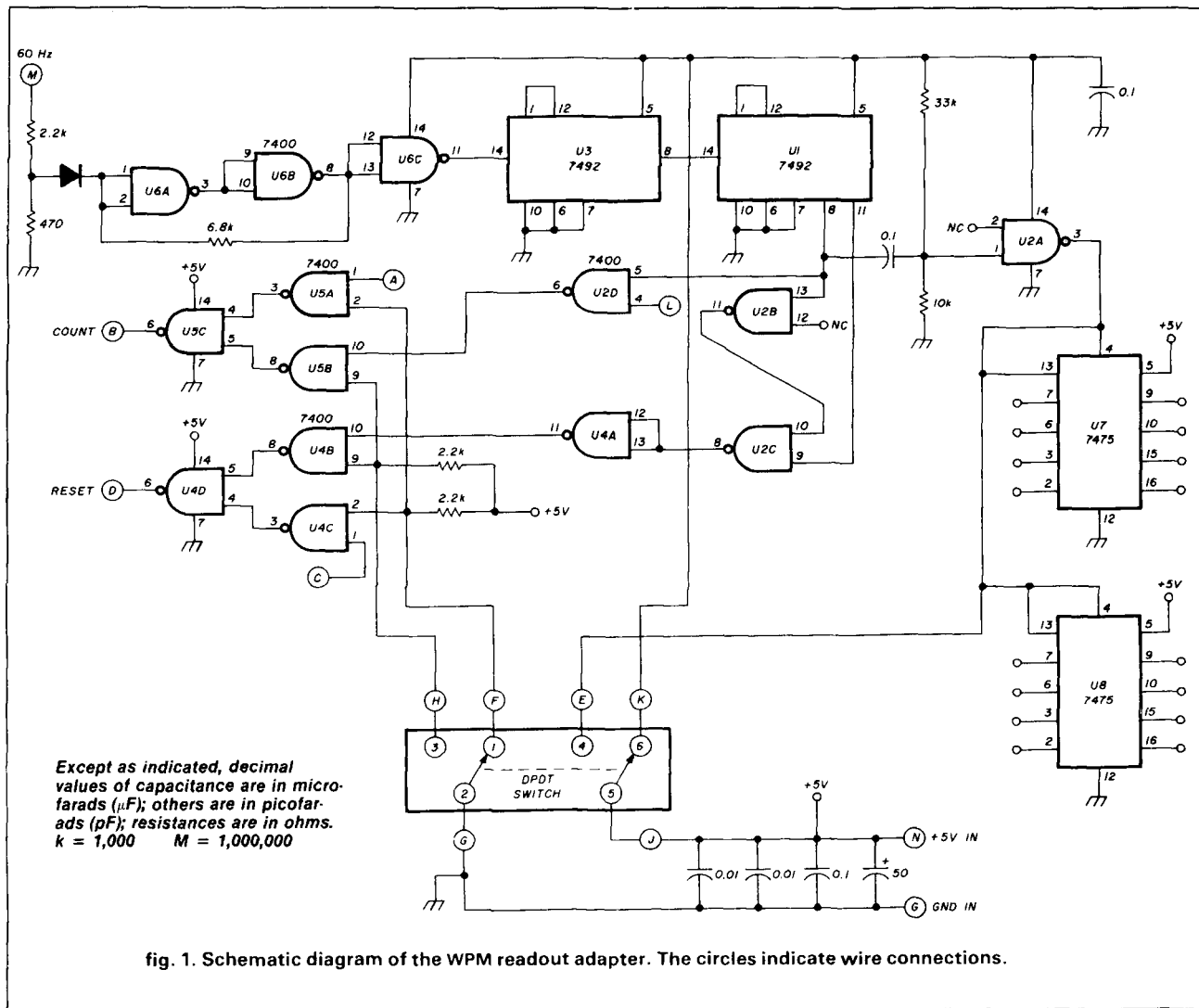

fig. 1. Schematic diagram of the WPM readout adapter. The circles indicate wire connections.

turns on the 5-volt supply for IC U1, U2, U3, and U6. The switch also grounds pin 2 of U4C and U5A, blocking out the count and reset pulses from the memory chip. Sixty Hz is fed into U6 from the power-transformer secondary. The 60-Hz waveform is shaped and conditioned by U6 and is fed into U3 (divide by 12). The output of U3, pin 8 (5 Hz) is fed into a second divide-by-12 IC, U1. The output of pin 8 of U1 is 2400 milliseconds, or 2.4 seconds long. This pulse is fed to pin 5 of the U2D NAND gate, which is high for 1.2 seconds and low for 1.2 seconds. During the high on U2D pin 5, the gate is held open, which allows the clock input pulse on pin 4 to pass through for a 1.2-second period. This count is in words per minute; that is WPM equals the number of clock pulses per 1.2 seconds. When pin 8, U1 goes low after the count time is concluded, pin 1 of U2A is pulsed, causing a high strobe pulse at its output and

at pins 4 and 13 of U7 and U8. This action momentarily opens the 7475s, which latch onto the count and display it through the readouts. A pulse at pin 9, U2C resets the counters to zero and a new count begins.

In the **NORMAL** mode of operation, pins 9 of U4B and U5B are grounded, blocking the WPM counter and reset pulses, which allows the normal memory bit count and reset pulses to pass through to the counters. The other half of the DPDT switch removes the 5 volts from U1, U2, U3, and U6. This disables them and places 5 volts on the 7475 latches, holding them open to allow a steady bit count to be displayed.

construction

The speed adapter board uses eight inexpensive ICs, about \$3 worth. The whole project shouldn't cost over \$10 if all the parts have to be purchased

New Drake TR5 Transceiver



far above average!

COMING SOON:
RV75 Synthesized VFO
featuring the Drake "VRTO"

- * Frequency Synthesized for crystal-controlled stability * VRTO (Variable Rate Tuning Oscillator*) adjusts tuning rate as function of tuning speed.
- * Resolution to 10 Hz * Three programmable fixed frequencies for MARS, etc. * Split or Transceive operation with main transceiver PTO or RV75

* Patent pending

With the new TR5 versatility and value are spelled D-R-A-K-E...

DYNAMIC RANGE

The dynamic range of the TR5 is unexcelled by any transceiver in its class. The TR5's greater than 0 dBm third order intercept point (85 dB two-tone dynamic range) at 20 kHz spacing can be achieved only by the use of a passive diode-ring double balanced mixer. Drake was the first to bring this technology to the Amateur market with a high-level mixer in the TR7.

RELIABLE SERVICE

When you purchase a TR5, or any Drake product, you acquire a product of the latest production techniques, which provide reliable performance.

Yet with a product as sophisticated as one of today's transceivers, after-sales service is a must. Ask any Drake owner. Our Customer Service Department has a reputation second to none.

ACCESORIES

Drake is the only Amateur Radio manufacturer who offers a full complement of accessories to satisfy almost every desire the HF Amateur may have. This wide selection allows any operator to assemble a station which meets his needs, and assures compatible interfacing and styling instead of a desk full of equipment with a variety of styling and poor operation as a system.

KILOWATT AMPLIFIER

Everyone wants to be heard! The accessory L75 and its 3-500Z (1200 watts PEP input) and a decent antenna will do the trick. This rugged self-contained amplifier/power supply will put the TR5 on an even footing with the best of them.

ENGINEERING

The TR5 and all Drake Transceivers, are backed by the best in engineering. The TR5 is the result of an extensive engineering effort, combining proven past techniques and ideas with new state of the art concepts.

As a result, the TR5 will not be superseded by a new model every six months. It represents a true radio communications value that will provide many years of operating enjoyment.

See your Drake dealer
or write for
additional information.

R. L. DRAKE COMPANY



540 Richard St., Miamisburg, Ohio 45342, USA
Phone: (513) 866-2421 • Telex: 288-017

Features, availability and prices subject to change without notice or obligation.

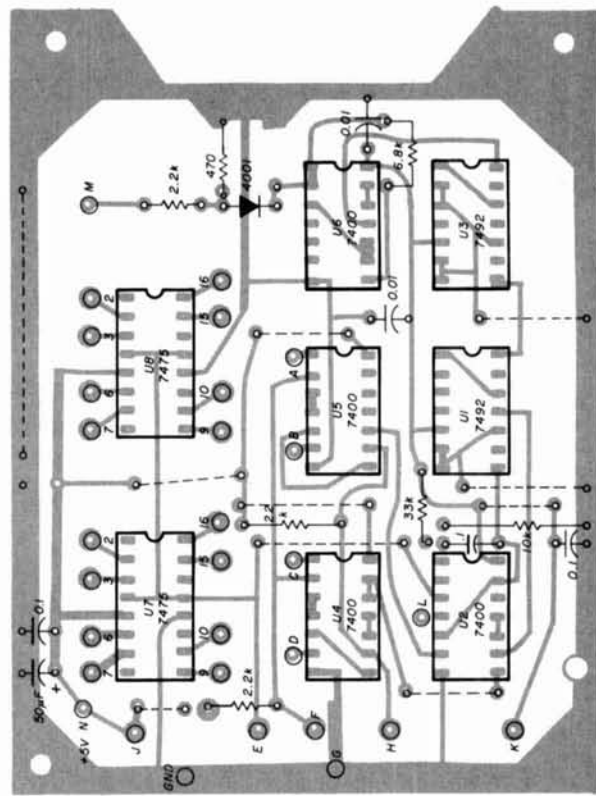
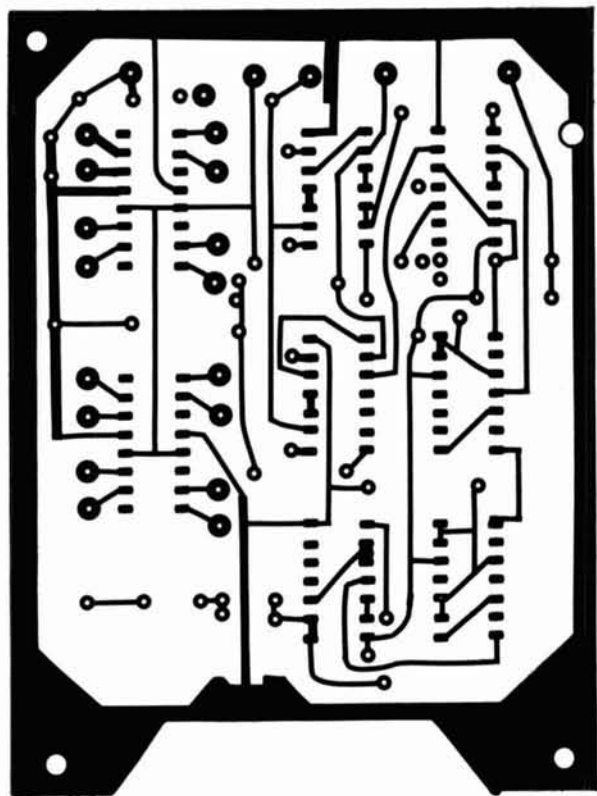

fig. 2. Foil side, *A*, and component side, *B*, of the speed adapter board. Dotted lines are wire jumpers.

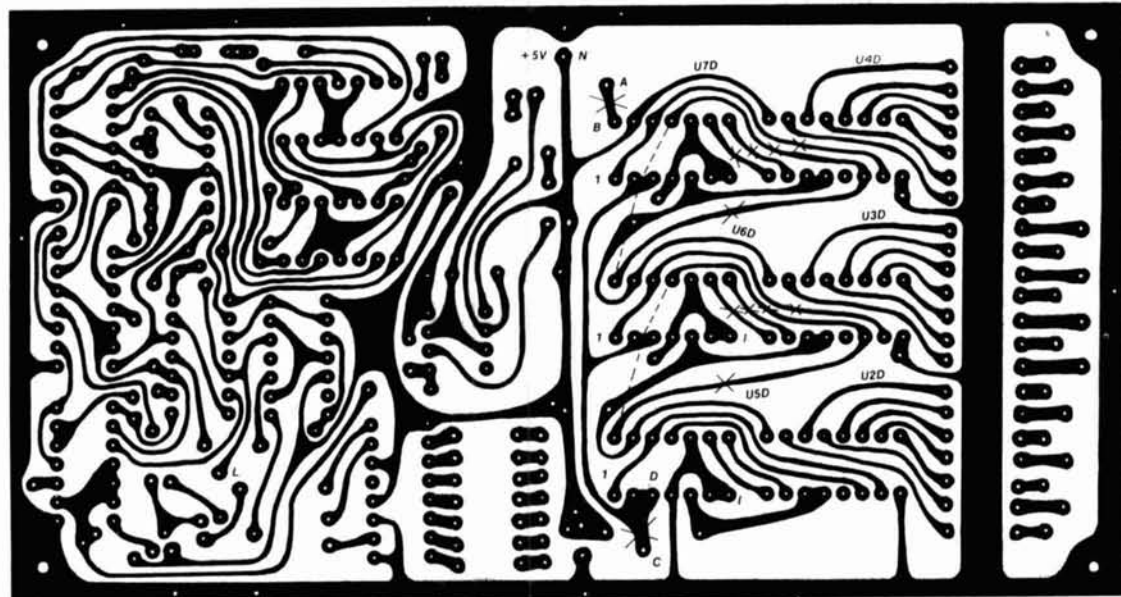

fig. 3. Foil side of Deluxe Memory Keyer driver board. Cut foil at 12 points marked with *X*. Connect wires from speed adapter board to identical letters on driver board. Add two jumper wires as indicated by dotted lines.

new. Components are mounted on the non-foil side of the board, as shown in **fig. 2**. All resistors can be ¼ watt. Capacitors are disc, except the 50 µF, which can be either electrolytic or tantalum at 10 volts. Dotted lines indicate jumper wires. Be sure the ICs are oriented correctly. I used sockets for the ICs, which makes them easier to change in case I zap one. Care must be taken when soldering in the sockets to prevent solder bridges across the pins. (I can supply a limited number of drilled and etched circuit boards for \$6 each.)

The hookup requires 30 wires, so ribbon cable is the best route to follow. The jumper wire along the edge of the board in **fig. 2** is used to anchor the ribbon cable to the board. Mount the cable here first and leave about 5 inches (13 cm) for a hookup, then peel back each wire to the jumper anchor before routing to the designated letter. Measure and route each wire separately to its terminal. Cut, insert and solder each wire by number as shown in table 1 to avoid a mixup.

driver board

To prepare the driver board, the foil must be cut in twelve places as shown in **fig. 3**. Also add two jumper wires as shown by the dotted lines, from pin 11 of U7D to pin 14 of U6D, and from pin 11 of U6D to pin 14 of U5D.

wiring the driver board

The ribbon cable can now be installed on the driver board. Leave about 1½ inches (4 cm) of the cable between the boards for a hinge, and anchor the ribbon on the foil side of the driver board with a jumper wire across it. Leave about 7 inches (18 cm) of the ribbon on the free end. Peel back the first twenty-four wires to the anchor point. The last six wires may stay together. Run the last six wires to the DPDT switch and solder them on as indicated in **table 1**. All the connections to the driver board will be made on the foil side. Tack each of the first sixteen wires to the IC pin numbers as indicated in **table 1**. The next six wires go to the indicated letters. The twenty-third wire goes to either side of the secondary of the power transformer. The twenty-fourth wire is soldered to point L, in the keyer section of the driver board. The speed adapter board is mounted directly over the driver board with spacers in between.

operation

With the switch in the WPM position, a string of dots about 3 seconds long will give an exact WPM count on the readout. Set the speed control to the speed at which you would like to send. The readout will receive a count update every 2.4 seconds. Any hesitations during sending will show a corresponding

table 1. Wire connections for 30 wire ribbon cable from speed adapter board to driver board and to DPDT mode switch.

from driver board			to adapter board		
wire no.	device	pin no.	device	pin no.	pin no.
1	U3D (7447)	7	U8 (7475)		9
2		6			15
3		2			16
4		1			10
5	U4D (7447)	7	U7 (7475)		9
6		6			15
7		2			16
8		1			10
9	U6D (7490)	8	U8 (7475)		2
10		9			6
11		11			3
12		12			7
13	U7D (7490)	8	U7 (7475)		2
14		9			6
15		11			3
16		12			7
17	reset C		reset C		
18	reset D		reset D		
19	bit count A		bit count		A
20	bit count B		bit count		B
21	ground		ground		G
22	+ 5 volts		+ 5 volts		N
23	ac secondary transformer		ac in		M
24	U4-7474 CI pulse		CI pulse		L

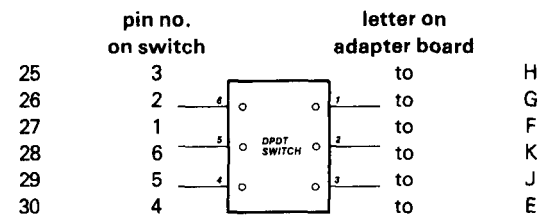

Two jumper wires on driver board

wire pin 14, U6D to pin 11, U7D
 wire pin 14, U5D to pin 11, U6D

slower speed on the readout. With the switch in the normal position the keyer will operate as it did before the adapter board was installed. The bit count from or to the memories will be displayed on the readout.

references

1. *The Radio Amateur's Handbook*, Fifty-seventh edition, 1980, ARRL, Newington, Connecticut 06111
2. Robert C. Cheek. W3VT, "Deluxe Memory Keyer," *ham radio*, April, 1979.

ham radio

BARKER & WILLIAMSON

VERTICAL ANTENNAS

MODEL 370-31 Slim Line Vertical designed for 10, 15, 20 and 40 meters. All traps pretuned. Overall height 21 feet. Can be used with or without ground radials. Model 370-33 — 75 meter add on kit. 75 and 80 meter operation optional with model 370-33 add on kit. Power rating 1 KW-2 KW P.E.P.

MODEL 370-30 Economy model vertical for 10, 15, 20 and 40 meter operation. High Q factory tuned traps. Overall height 21 feet. Can be used with or without ground radials. Model 370-32 — 75 meter add on kit. 75 and 80 meter operation optional with model 370-32 add on kit. Power rating 1 KW-2 KW P.E.P.

MODEL 370-34 Radial Kit. Radial Kit for Models 370-30 and 370-31 Vertical antennas. All necessary wire and hardware for two ground plane radials. Write for more details and other antenna products.



Barker & Williamson, Inc.
10 Canal St., Bristol, Pa. 19007
215-788-5581



UNADILLA/REYCO HAM products that go the Dx.

Round after round of transmission, durable all-weather UNADILLA/REYCO baluns, traps and kits will take you the distance. Unadilla/Reyco will suppress feedline radiation and maximize antenna efficiency better than any competitive HAM line.

The Big Signal W2AU Balun gives you the right connection between any antenna and transmitter. The W2AU Balun can withstand 600 lbs. of pull, has a built-in lightning arrestor and can handle full legal power. For more than 20 years, it's been the choice of HAMS, Armed Forces and commercial communication around the world.

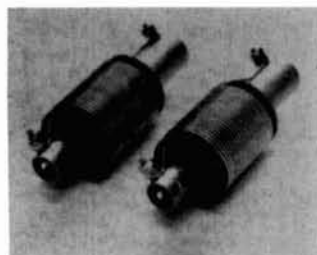

The Old Reliable W2VS Reyco Trap will always give you the perfect dipole. Professionals demand Reyco Traps because they're weatherized and can withstand 500 lbs. of pull. Developed by veteran HAM W2VS, Reyco Traps are paired by precision frequency.

The W2AU/W2VS 5-band Antenna Kit includes everything for low SWR on 40 and 80 meters, and resonants on 10, 15 and 20. The quality crafted components in this kit are time tested by HAMS around the world.

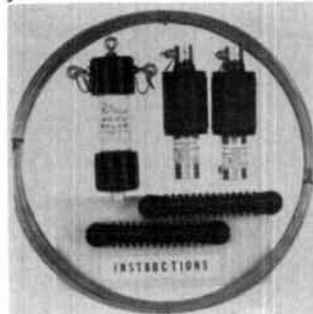

Other Unadilla/Reyco products include low pass filters, quad parts, insulators and endsulators. Call for our free catalog and the name of your nearest dealer. Hamfest managers: we cooperate. Remember: Unadilla/Reyco will take you the distance.

UNADILLA/REYCO
Division of Microwave Filter Co., Inc.

6743 Kinne St., East Syracuse, NY 13057
Toll Free 1-800-448-1666 TWX 710-541-0493
NY/HI/AK/Canada (collect) 1-315-437-3953

FOREIGN HAMS

LONDON: AMCOMM 01 804 1166/VICTORIA: Scalar 725 9677/PUNTA ARENAS: Novedades Rasmussen 22327/BUENOS AIRES: Multi-Radio 773-1266/COL. ANAHUAC: Radiac 2-50-32-40/France: SFL (90) 5339 40 (90) 611258

THERE IS A DIFFERENCE IN QUARTZ CRYSTALS

International's leadership in crystal design and production is synonymous with quality quartz crystals from 70 KHz to 160 MHz. Accurately controlled calibration and a long list of tests are made on the finished crystal prior to shipment.

That is why we guarantee International crystals against defects, material and workmanship for an unlimited time when used in equipment for which they were specifically made.

Orders may be placed by Phone: 405/236-3741.
TELEX: 747-147. CABLE: Incrystal · TWX: 910-831-3177 · Mail: International Crystal Mfg. Co., Inc., 10 North Lee, Oklahoma City, Oklahoma 73102.

Write for information.

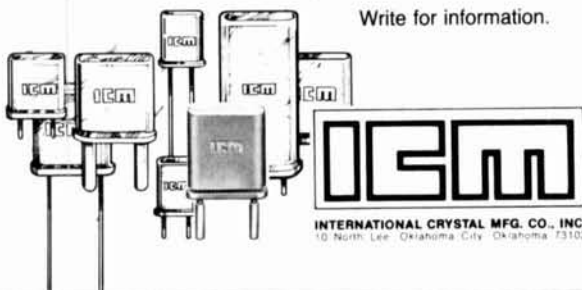

operation upgrade: part 6

The sixth part
in a continuing series
designed to help you
upgrade your ticket

This series of articles is being presented to help you pass a higher grade Amateur license exam, to give you the basic radio theory needed to pass a Novice, Technician/General, or Advanced class license test. After these basics are presented in as simple a form as possible, there will be articles covering Extra class license subjects.

This month we will examine the three basic forms in which active devices can be connected in amplifier circuits. Also, feedback and decibels will be outlined briefly.

classes of amplifiers

When active devices are used in amplifying circuits, the portion of the time that current flows in them determines the class of operation. The class of operation also helps to determine the efficiency of the amplifying stage. The three basic classes of operation are class A, class B, and class C. Most amplifiers are operated in class A, so we will discuss this class first.

Class A operation is the least efficient, but also distorts the amplified signal the least. Let's consider the solid-line curve of fig. 1 first. Represented vertically,

at the left, is the output circuit current (drain, collector, plate). Represented horizontally is negative, zero, and positive bias voltage for N-channel FETs or for VTs (vacuum tubes). You will note that the class A bias value is about halfway between output current cutoff and zero bias (or output current maximum). The shaded area illustrates the output-circuit current variations that occur with both a small input ac signal (e_i), and then a higher amplitude input signal. If the large input signal were made much greater it would drive the device into output current cutoff, or into the bent part of the curve at the top, or both.

Under the maximum undistorted output signal condition shown, the efficiency of the amplifier stage (its ac power output compared with its output circuit dc power input) would be about 45 percent (the theoretical maximum is 50 percent). With a small input signal, the dc power input to the output circuit averages the same but the ac power output will be much less because the output dc current varies less. In this case the efficiency of the stage might be only 5 or 10 percent. Normally, the efficiency of an operating class A audio amplifier averages about 25 percent. Class A operation has the advantage of requiring only a single active device to produce relatively undistorted amplification. This class of amplifier can be used for both audio and radio frequency amplification when distortion must be kept to a minimum.

Can you see that if the operating curve of the active device used happened to be curved or nonlinear (which it usually is), as is shown dashed, that even if

By Robert L. Shrader, W6BNB, 11911 Barnett Valley Road, Sebastopol, California 95472

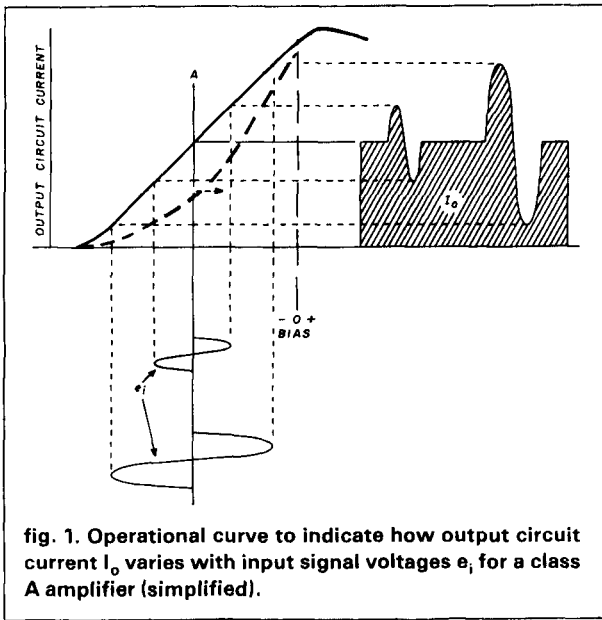

the input signal voltage had equal positive and negative peaks, the output circuit dc variations would be smaller for the negative half cycle of input ac, and larger for the positive half? This would produce a noticeably distorted output audio signal from such a stage. It would produce harmonics of all frequencies it amplified.

Class B operation is more efficient than class A but usually distorts more than class A; it requires two *push-pull* devices (first one operates and then the other) in a single stage for audio amplification. In the two-stage amplifier shown in **fig. 2a** the first stage is a JFET class A *single-ended* af amplifier (one device used and one end of its load grounded or bypassed to ground) which is transformer-coupled to a push-pull class A or B power amplifier second stage, transformer-coupled to a loudspeaker. Whether the output stage is biased to class A or B is determined by the values of bias developed by R_1 and R_2 . The curve shown in **fig. 2b** indicates that with no bias at all on the BJT ($R_1 = \text{zero ohms}$) there is no collector current with no input signal. The bases of the two NPN transistors must be forward biased a little to produce class B operation ($R_1 = \pm 5 \text{ ohms}$). The BJT bases must be forward biased considerably more to put them in class A (dashed line). With class B bias, only the positive half of the input signal produces I_C in the transistor whose curve is shown.

Assume this curve is for the top BJT. Then during the next half cycle of the input signal, the top BJT will have no I_C flowing, but the lower BJT is now being driven by the second half of the input ac signal. The voltages at the top and bottom of the center-tapped input transformer secondary will be 180° out

of phase with each other. As the top BJT is being fed the signal as a negative (reverse) voltage, the lower BJT is being fed the same signal but as a positive (forward) voltage, and the lower BJT now has I_C flowing in it. In this way the output transformer primary has current flowing first in its top half and then in its bottom half. Both primary currents induce voltages into the secondary to feed power to the loudspeaker. Can you see that each BJT is working only about half of the time? For example, during much of the second half cycle of the input signal, the top BJT rests (cools). As a result, a pair of class B biased active devices will produce much more power output than two parallel-connected (B to B, E to E, and C to C) class A devices, both of which would have current flowing in them at all times. Practical class B stages can operate with maximum efficiencies in the range of 55 percent. If a single BJT in class A is capable of 1 watt output, two connected in parallel would be capable of 2 watts output, but two in *push-pull* could be driven to produce about 8 watts output if in class B, partly because of their ability to rest almost half of the time, plus the fact that a greater input signal could be accommodated with class B bias. When producing power output all active devices must have effective heatsinks attached to their collectors, drains, or plates.

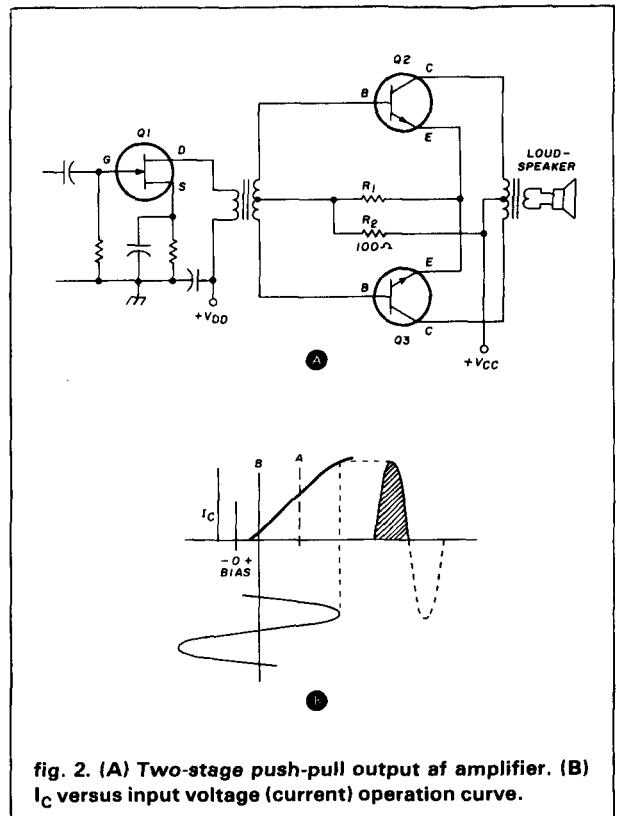

It should be mentioned that you will normally find BJT curves plotting emitter-collector voltage versus collector current with a series of more or less parallel horizontal lines indicating various base (input circuit) current values.

Class AB operation means biasing to some point between class A and class B. For audio amplifiers this also requires that two push-pull devices be used. As you might expect, class AB is in between classes A and B as far as power output and distortion are concerned. When using push-pull class A and class AB there is one other advantage. The two devices are operating 180° out of phase with each other so that any bend in the operating curves, which normally produces distortion in the output of a single ended stage, will be cancelled by the reversed curve (effectively) of the other device. This results in nearly distortion-free amplification in such push-pull stages. When using vacuum tubes (and N-channel FETs) class AB₁ indicates the input signal should never be

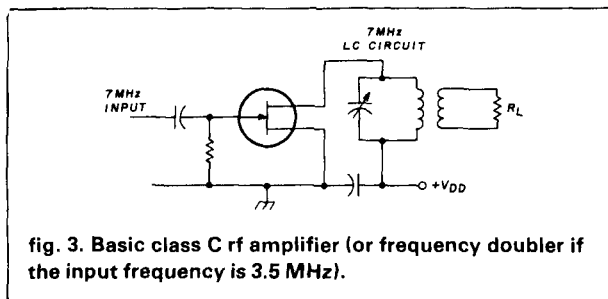

fig. 3. Basic class C rf amplifier (or frequency doubler if the input frequency is 3.5 MHz).

great enough to drive up into the positive bias area and produce grid (gate) current. Class AB₂ operation implies some grid current and that the input circuit resistance (impedance) is engineered low enough so that when the signal does drive into an input current condition, there will be no unwanted voltage drops developed across any resistance in the input circuits to produce distortion.

Class C operation is not used with audio amplification, but usually only in transmitter rf amplifiers or in oscillators. Class C stages are normally biased from 1.5 to perhaps four times the cutoff, or pinchoff, bias value. (Technically, a BJT with zero bias is in class C.) As a result, for a major proportion of the 360° of any input cycle (perhaps 240°) the device has no output circuit current; it's resting. It can produce maximum output power at perhaps 65 percent efficiency. This means that the output circuit current comes in relatively narrow (120°), high-amplitude pulses. If these powerful pulses are forced through an output LC circuit tuned to some radio frequency, such as 7 MHz (as in fig. 3), the pulses shock-excite the LC circuit into flywheel oscillation and produce nearly sinusoidal 7-MHz rf ac output from it. Of course, the

input rf ac to such a class C amplifier should also be at 7 MHz, although if it is at 3.5 MHz the circuit will operate as an rf frequency doubler. Since class C amplifiers depend on the flywheel effect of relatively high-Q LC circuits to produce the output ac, the stages may use either single-ended one-device circuits, or may use push-pull circuits. Push-pull rf ac circuits produce less even-order (second, fourth, sixth, and so forth) harmonic ac output, and may be desirable to suppress such frequencies. If the coupling to a load on a single-ended class C rf amplifier (R_L in fig. 3) is too tight it will lower the Q of the LC circuit involved and drain the flywheel energy on the undriven half cycle too much. This will reduce the amplitude of the second flywheel half cycle and distort the sinewave shape of the ac wave. This develops harmonics and unwanted radiations. Push-pull stages do not have this difficulty as much as single-ended stages.

common-emitter type amplifiers

There are three basic methods of connecting and feeding three-element amplification devices such as FETs, BJTs, and VTs. Let's examine the basic theory as it applies to bipolar junction transistors. The most common amplifier circuit configuration is that of the common-emitter (common-source for FETs, common-cathode for VTs), also known as the grounded-emitter (-source, -cathode). The circuit shown in fig. 4 illustrates a single-ended NPN BJT class A amplifier. R_1 and R_2 provide the forward bias for the transistor. R_3 produces the stabilizing bias to keep the transistor from thermal runaway in power stages. R_L is selected to produce a voltage-drop across itself with no signal input, of perhaps one third to a half of the V_{CC} value (depending on the R_3 value). R_L will probably be in the 1 to 5 kilohm range, depending on the beta of the transistor, the bias value, and the V_{CC} value. For af amplification the input and output coupling capaci-

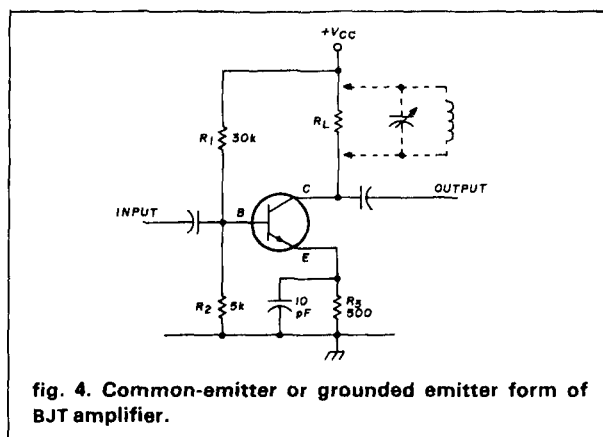

fig. 4. Common-emitter or grounded emitter form of BJT amplifier.

tances would be in the 5 to 15 μF range. The lower the lowest frequency to be amplified, the larger the capacitance values required. For high-frequency rf amplification the capacitors might be in the 0.01 to 0.1 μF range, but such an untuned rf amplifier is not often used. In rf amplifiers the R_L would usually be supplanted by a tuned LC circuit, shown dashed.

Generally, regardless of the V_{CC} value, the load resistor and bias values are selected so that with no signal input the voltage-drop across R_L will be equal to the E_C voltage-drop for good class A operation.

Common-emitter-type circuits represent a relatively low impedance load for the stages ahead of them, perhaps 50 to 200 ohms, and look like a medium impedance to the stages that follow. With FETs, **fig. 5**, the common-source circuit usually uses a resistor between source and ground to provide bias. The input impedance of this stage in class A operation is essentially as high as the resistance of the gate-to-ground

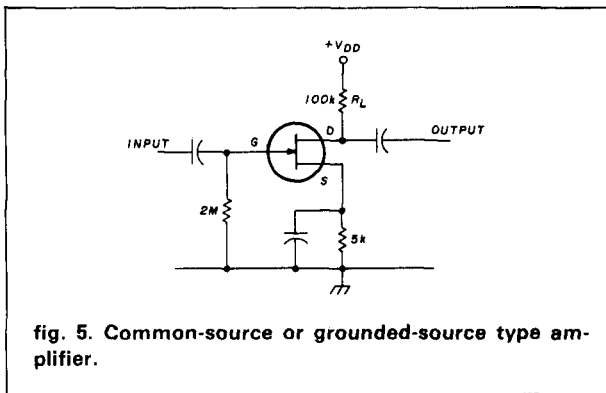

fig. 5. Common-source or grounded-source type amplifier.

resistor used in it. The output circuit impedance is perhaps one half of the resistance of the drain load resistor, R_L . If using tuned LC circuits for rf amplification, the output impedance may be several hundred to several thousand ohms. Vacuum tubes are similar to the FETs in impedance and component values. The phase shift of a signal amplified by all of these common-emitter type circuits is usually considered to be 180° .

common-base type amplifiers

A common-base, or grounded-base (-gate, -grid) amplifier is shown in **fig. 6**. R_1 and R_2 form a voltage divider across the power supply ($+V_{CC}$ to ground). Since the base is connected up the voltage divider from ground it is more positive than the emitter, which returns to ground through the input resistor. The amount of forward bias required to produce class A operation is that which will produce a static (no signal) I_C value somewhat less than half the maximum rated I_C value. C_1 is a filter capacitor whose

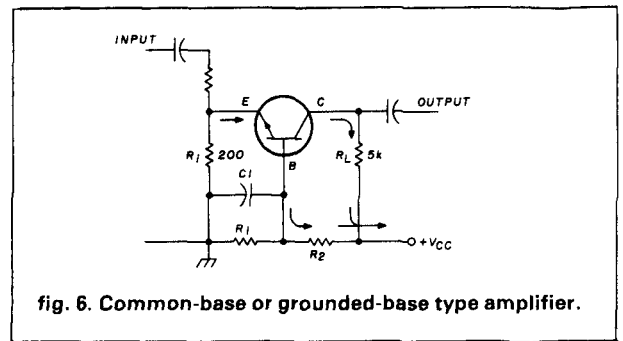

fig. 6. Common-base or grounded-base type amplifier.

function is to prevent any signal voltage variations from developing across R_1 as the input signal forces the I_B to change at the signal frequency and amplitude. Input-signal currents through the 200-ohm input resistor develop varying voltage-drops across it. Since these varying voltages are between base and emitter they force the collector current to vary, producing an amplified voltage-drop variation across the relatively high resistance load resistor. Can you see that the emitter current is the sum of both base and collector currents (arrows)? Therefore, the ratio of I_C to I_E will always have to be something less than 1, usually in the range of 0.95 to 0.98. This ratio or value is known as the *alpha* (α) of the transistor. The *alpha cutoff frequency* is the frequency where the gain of the transistor drops to 0.707 of its gain at 1 kHz.

Although a common-base circuit cannot have a current gain, it can have a voltage gain and therefore a power gain. If the signal voltage applied to the 200-ohm resistor is going positive, the base, being held constant by C_1 , can be considered to be going relatively less positive than the emitter. We can say the base or control element is going relatively more negative. Such a reverse bias to the base reduces the I_C and the voltage drop across R_L decreases. This allows the top of R_L to become more nearly the $+V_{CC}$ value, or more positive. Therefore, as the input goes more positive so does the output, representing a phase shift of zero. With 0° phase shift there is little likelihood that this circuit will become regenerative and produce oscillations on its own. This is one of the advantages of such circuits. We say they are inherently stable, meaning that they are not likely to break into unwanted oscillations. When using vacuum tubes and an LC circuit in place of R_L , the equivalent circuit is known as a grounded-grid amplifier and is used in many of the present-day high-power Amateur rf linear amplifiers.

common-collector-type amplifiers

The third basic form of amplifier circuitry is the

common-collector, or grounded-collector (-drain, -plate) circuit, **fig. 7**. At first glance it may look like a common-emitter circuit, until you note that there is no load resistor in the collector circuit. Instead, the load resistor, R_L , is also the emitter resistor, R_E . Note that the collector is held at ac-ground potential by the relatively large value bypass capacitor, C_{bp} . An input signal applied base-to-ground causes I_C and I_E variations, which in turn produce variations of the voltage drop across R_E . The output voltage variation across R_E will always be a little less than the input voltage being fed to the base. However, this circuit has both current gain and power gain. Because a positive going signal to the gate produces an increase in I_C and therefore a more positive emitter, the common-base circuit produces zero phase shift of the amplified signal current. With 0° phase shift the circuit produces no regeneration and cannot break into oscillation, even at high frequencies. It is used mostly as an impedance-changing circuit. The input impedance is usually about half the value of R_i . With a high value of R_i the grounded-collector circuit acts as an impedance reducer, somewhat like a step-down transformer, except that a transformer cannot produce any power gain. This circuit is also known as an emitter-follower (source-follower, cathode-follower).

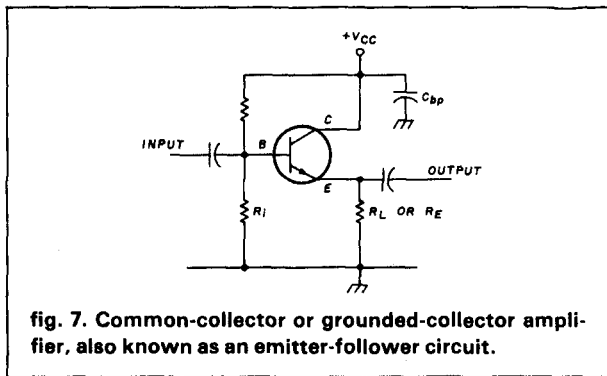

feedback

The term *feedback* deserves a little more explaining, since there is some of it in most circuits in which amplification occurs. The term itself indicates that a signal voltage (or current) being fed into an amplifier stage is amplified, and then part of the amplified output voltage (or current) is fed back into the input circuit. Assuming no time difference (phase shift) between the input signal voltage and the output, if the ac feedback voltage is out of phase 180° , or degenerative, the net result is a lessened effective input signal voltage, and therefore a lessened total gain of the stage. If there had been any distortion of the signal

voltage (any change in the signal's waveshape) produced by the amplifying process of this particular stage (due to nonlinearity of its operating curve, for example) this distortion is also fed back 180° out of phase. This can almost completely cancel out any such distortion produced by the stage. Of course, if the input signal voltage were distorted to begin with, the degenerative feedback could not correct that. Degenerative, or *inverse*, feedback is used in many linear af amplifier systems, and may be developed as a degenerative loop feeding back distortion-cancelling voltages from a third stage back to a first stage, for instance.

The actual gain of a stage with inverse feedback can be determined by the formula

$$A_f = \frac{A}{1 + (-\beta)A}$$

where A_f is the amplification or voltage gain with feedback, A is the amplification without feedback, and $-\beta$ is a decimal fraction of output voltage (or current) fed back to the input. As an example, an amplifier without feedback has a gain of 20. What is its gain if the feedback factor is 5 percent (5 percent = 0.05)? Try working out this problem. Your answer should be an undistorted gain of only 10. With such inverse feedback, signal gain may be reduced, but when undistorted output is paramount this loss can be made up by merely adding another stage with inverse feedback. Furthermore, without feedback the gain of an amplifier stage might drop to a 50 percent output voltage at some lower frequency (due to the R and C values used in it). With the 5 percent feedback, at the original half-voltage frequency the output will now drop only about 10 percent. Thus, inverse feedback widens the bandwidth (spread of frequencies amplified almost equally) of an amplifier. In addition, instead of developing a 45° phase shift at the original half-voltage frequency, the resultant phase shift will be reduced to about 27° . So inverse feedback also reduces any undesirable phase shift (another form of distortion) in an amplifier.

If the feedback is close to 0° it has the tendency to make the stage around which it is introduced increase its gain (particularly at one frequency) if the feedback percentage is small. If such a forward or regenerative feedback is increased, it will usually cause the gain to rise so much at the frequency at which the greatest gain is being produced that the stage will break into oscillation at this frequency. As you may have deduced, both positive (regenerative) and negative (degenerative or inverse) feedback can be either an advantage or a disadvantage in electronic circuits.

decibels

You have probably noted that all of the amplifier

circuits have power gains, although the common-collector has no voltage gain, and the common-base has no current gain. We often talk about amplifier gain in terms of *bels* (after Alexander Graham Bell), or more commonly in tenths of bels (deci = 1/10), called *decibels*, or dB. Basically, a 3 dB gain means an approximately two-times output-over-input power gain. Another 3 dB, or a total of 6 dB gain represents an output of approximately twice plus twice more, or a four times gain. A gain of 10 dB is a power gain of exactly ten times. Thus, if an amplifier has 10 dB gain it amplifies the power fed to its input ten times. (We are speaking of power amplifiers here, not the usual class A FET or VT voltage amplifier which has essentially no power input but may have considerable power output.) If a power amplifier has 13 dB gain, it amplifies ten times (10 dB) plus 3 dB more, or twice ten, for a gain of twenty times the input power. What would be the power gain of an amplifier that has 16 dB gain? Can you see that the output would be ten times, plus being doubled again, then doubled again (10 dB + 3 dB + 3 dB), for a total gain of forty times the input power?

Since power is proportional to either the E^2 or the I^2 (from $P = E^2/R$, and $P = I^2R$), the voltage gain of an amplifier (assuming input and output impedances to be equal) in dB will be the square root of the power gain. A power gain of 6 dB is the equivalent of a four times power gain. The square root of 4 is 2. Therefore, 6 dB is the equivalent of a voltage (or current) gain of two times. If receivers have signal-strength-indicating meters (S-meters) and each S-unit is calibrated to be 6 dB greater than the one lower, one S-unit is equivalent to doubling (or halving) the signal voltage applied to the input of the receiver.

For accurate computations of decibels the formula to use is:

$$dB = 10 \log \frac{P_1}{P_2} \quad \left(\text{from } B = \log \frac{P_1}{P_2} \right)$$

where P_1 is the larger power value being considered.

Variations of this formula to determine dB gain or loss using voltage or current values, again assuming input and output impedances to be equal, are:

$$dB = 20 \log \frac{E_1}{E_2}$$

$$dB = 20 \log \frac{I_1}{I_2}$$

If you use a table of logarithms you can solve dB problems using these formulas. For example, what is the dB gain if the input is 10 watts and the output is 20 watts? We have already given you the information to obtain an approximate answer of 3 dB. But let's

try this problem using the first dB formula:

$$dB = 10 \log \frac{P_1}{P_2}$$

$$dB = 10 \log \frac{20}{10}$$

$$dB = 10 \log 2$$

From a log table, pocket calculator, or slide rule, if we can determine that the log of the number 2 is 0.301. So, ten times 0.301 means 3.01 dB is exactly twice the power. If the power input were 20 watts and the output 10 watts, the ratio is still equal to 2:1, or 3.01 dB, but now it is a loss of 3.01 dB, which may be expressed as -3.01 dB. You may not be given dB problems to work in an Amateur test, but you might! In any case you might want to memorize these ballpark dB values:

1 dB = 1.25 times the power
(a 25 percent power increase)

3 dB = 2 times the power
(a 100 percent increase)

6 dB = 4 times the power

9 dB = 8 times the power

10 dB = 10 times the power (exact)

20 dB = 100 times the power (exact)

30 dB = 1000 times the power (exact)

If you have a beam antenna with a 20 dB gain and you feed it 100 watts of rf ac, how much more power does it put out in its direction of maximum radiation? _____ . Wow! Where can I get an antenna like that?

FCC test topics

The following Technician/General test topic is discussed in this article, but should be understood by Advanced applicants also:

- decibels

The following Advanced class test topics are discussed in this article:

- amplifiers, classes A, AB, B, C, characteristics
- common-emitter class A transistor amplifiers, bias network, signal gain, input and output impedances
- common-collector class A transistor amplifier, bias network, signal gain, input and output impedances.

For more information on these subjects it is recommended that you refer to a textbook such as *Electronic Communication*, by Robert L. Shrader, McGraw-Hill Book Company, available through Ham Radio's Bookstore, and to radio handbooks.

ham radio

	SUNDAY	MON	TUES	WED	THUR	FRI	SATURDAY
<p>WIAW Schedule October 25, 1981-April 24, 1982 WIAW code practice and bulletin transmissions are sent on the following schedule:</p> <p>EST Show Code Practice MWF: 8 A.M., 7 P.M.; TTSSO: 4 P.M., 10 P.M. RTTY Bulletin D: 5 P.M., 8 P.M., 11 P.M.; MTWTF: 10 A.M., 10 P.M. CW Bulletin D: 8:30 P.M., 12:30 A.M.; MTWTF: 11 A.M., 11 P.M. CST Show Code Practice MWF: 8 A.M., 8 P.M.; TTSSO: 3 P.M., 9 P.M., 10 P.M. RTTY Bulletin D: 4 P.M., 7 P.M., 10 P.M.; MTWTF: 9 A.M., 9 P.M., 10 P.M.; MTWTF: 10 A.M., 10 P.M. PST Show Code Practice MWF: 8 A.M., 4 P.M.; TTSSO: 1 P.M., 7 P.M., 10 P.M. RTTY Bulletin D: 3 P.M., 6 P.M., 10 P.M.; MTWTF: 4 P.M., 4 P.M., 8 P.M., 9 P.M.; MTWTF: 8 A.M., 8 P.M., 9 P.M. Voice Bulletin</p>	<p>WEST COAST BULLETIN - 9 PM PST (8 PM PT, 10:00 UTC) 35K KCS: A.1, 22 WPM - 1.</p>	<p>AMSAT East Coast Net 3650 kHz 8PM EST (10:00Z) Wednesdays Morning AMSAT Mid-Continent Net 3650 kHz 8PM CST (10:00Z) Wednesdays Morning AMSAT West Coast Net 3650 kHz 7PM PST (10:00Z) Wednesdays Morning</p>	<p>DX: XI to North American YL Contact, CW. For information contact: WAWZVN - 7.8.</p>	<p>SAROC CONVENTION, Las Vegas, NV. Contact: W7PEV - 14.</p>	<p>SP-DX Contest, CW - 34. APRIL Open CD Party, Phone - 34. ARRL International EME Competition - 34. LINCOLN TRAIL ARC Convention, Elizabethtown, KY. Contact: K4GSA - 3. MISSOURI STATE Convention, Kansas City, MO. Contact: W4KXUH - 3. CENTRAL ARKANSAS REN, Inc. Convention, Little Rock, AR. Contact: W5RXU - 3. MEMPHIS MINI-FEST, Pipkin Bldg., Mid South Fairgrounds, Memphis, TN. For information contact: K4FZJ - 3.</p>	<p>SP-DX Contest, phone - 17:18. GRP ARC OSO Party - 17:18. ARRL Open CD Party, CW - 17:18. WELLESLEY AMATEUR RADIO SOCIETY'S Auction, Wellesley, MA. Contact: W1WJ - 17:18. ARKANSAS STATE CONVENTION, Jackson, MS. Contact: K5VD - 17:18. TRENTON COMPUTER FESTIVAL, Contact: TC: 80, Trenton State Col. Open, Hillwood Lakes (N556), Trenton, NJ 08625 - 17:18. GREAT BAY RADIO ASSOCIATION Annual Hamfest-Flea Market, Somersworth Army, Somersworth, NH. Contact: N1EX - 17:18. SOUTHERN CALIFORNIA DX CLUB's 1982 International DX Convention, Holiday Inn, Visalia, CA. Contact: N6CC - 17:18. NORTH TEXAS AMATEUR RADIO ASSOCIATION Novice Miniregistration, Contact: K5CVN - 17:18.</p>	<p>MISSOURI VALLEY AMATEUR RADIO CLUB Pony Express Day, Contact: W9NH - 10. COMMONWEALTH CONTEST sponsored by Canadian Amateur Radio Federation, Contact: P.O. Box 2172, Station 'D', Ottawa, Ontario, K1P 5W4, Canada - 10:11.</p>
	4	5	6	7	8	9	10
	11	12	13	14	15	16	17
<p>RALEIGH ARE CONVENTION, Raleigh, NC. K9RY - 18. MOULTRIE AMATEUR RADIO CLUB'S Annual Hamfest, Moultrie (IL) County 4-H Center Fairgrounds, Contact: N5CDK - 18. QUAD CITIES AMATEUR RADIO CLUB special events station. For information contact: N8KY - 17:18.</p>	<p>WEST COAST BULLETIN - 9 PM PST (8 PM PT, 10:00 UTC) 35K KCS: A.1, 22 WPM - 19.</p> <p>AMSAT East Coast Net 3650 kHz 8PM EST (10:00Z) Wednesdays Morning AMSAT Mid-Continent Net 3650 kHz 8PM CST (10:00Z) Wednesdays Morning AMSAT West Coast Net 3650 kHz 7PM PST (10:00Z) Wednesdays Morning</p>	<p>AMSAT East Coast Net 3650 kHz 8PM EST (10:00Z) Wednesdays Morning AMSAT Mid-Continent Net 3650 kHz 8PM CST (10:00Z) Wednesdays Morning AMSAT West Coast Net 3650 kHz 7PM PST (10:00Z) Wednesdays Morning</p>	<p>DX: XI to North American YL Contact, CW. Contact: WAWZVN - 14-15.</p>	<p>DAYTON HAMVENTION, Dayton, Ohio. Contact: W4DZ - 23. Ohio Hamfest, Dayton, OH 45401 - 22-25.</p>	<p>SP-DX Contest, phone - 17:18. GRP ARC OSO Party - 17:18. ARRL Open CD Party, CW - 17:18. WELLESLEY AMATEUR RADIO SOCIETY'S Auction, Wellesley, MA. Contact: W1WJ - 17:18. ARKANSAS STATE CONVENTION, Jackson, MS. Contact: K5VD - 17:18. TRENTON COMPUTER FESTIVAL, Contact: TC: 80, Trenton State Col. Open, Hillwood Lakes (N556), Trenton, NJ 08625 - 17:18. GREAT BAY RADIO ASSOCIATION Annual Hamfest-Flea Market, Somersworth Army, Somersworth, NH. Contact: N1EX - 17:18. SOUTHERN CALIFORNIA DX CLUB's 1982 International DX Convention, Holiday Inn, Visalia, CA. Contact: N6CC - 17:18. NORTH TEXAS AMATEUR RADIO ASSOCIATION Novice Miniregistration, Contact: K5CVN - 17:18.</p>	<p>DAYTON HAMVENTION, Dayton, Ohio. Contact: W4DZ - 23. Ohio Hamfest, Dayton, OH 45401 - 22-25.</p>	
<p>WIAW QUALIFYING RUN - 25. ROCK RIVER AMATEUR RADIO CLUB'S Annual Hamfest, Dixon, IL. Talk in on 146:25 simplex. Contact: W09CJB - 25.</p>	26	27	28	29	30	30	*See Coming Events
	18	19	20	21	22	23	24

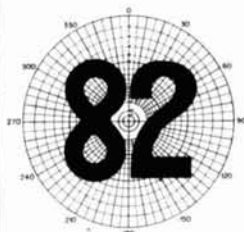

ANTENNA BOOK

NEW 14th EDITION

Now you can get the most comprehensive and up-to-date antenna data available today. It has the antenna design to fit your needs and preferences whether they be for Yagis, quads, wires, verticals, or specialized antennas such as the Beverage, curtain arrays, or special vhf/uhf applications. You'll find effective antennas for any kind of real estate from the apartment dweller to the true antenna farm. *The Antenna Book* not only provides practical antenna designs, but also gives the theory of antennas and transmission lines, including the application of Smith Charts.® Propagation phenomena are explained in detail.

The new edition will be ready for mailing in late April or early May. Estimated page count is 400. Price: \$8.00 in the U.S., Elsewhere in U.S. funds: \$8.50, at your dealer or direct from:

THE AMERICAN RADIO RELAY LEAGUE, INC.

225 MAIN STREET
NEWINGTON, CT 06111



Digital Multimeter

The Drake DM2350 Digital Multimeter is a convenient, small handheld liquid crystal display meter ideal for the serviceman or hobbyist. This 3½ digit meter is auto-ranging, auto-zeroing, has polarity indication, and an over-range warning signal. Battery life is greater than 300 hours with a "low battery" indicator. A continuity test sounds a signal when circuit resistance is less than 20 ohms. Dc accuracy is a basic 0.8%.

Batteries, probes, 20 amp current shunt, spare fuse and soft carrying case all included at **\$95.95**

Add **\$2.50** shipping and handling per order.

Send check with order and provide street address for UPS shipment. Ohio residents add Sales Tax. Charge card buyers may call toll free:

1-800-543-5612



In Ohio, or for information call:
1-513-866-2421

R. L. DRAKE COMPANY

540 Richard Street, Miamisburg, Ohio 45342

INSTITUTIONAL AND DEALER INQUIRIES INVITED

More Details? CHECK — OFF Page 92

MICROWAVE TELEVISION

The standard RP downconverter package shown below gives you a proven converter design mounted in a weathertight antenna that features **low wind loading** and **easy installation**.

With this package you are ready for hours of **Amateur television entertainment**. Just aim the antenna, connect one 75 cable from the antenna to the power supply and a second line from the power supply to your TV, and you are on the air.

All downconverter models use microstrip construction for long and reliable operation. A low noise microwave preamplifier is used for pulling in weak signals. The downconverter also includes a broad-band output amplifier matched to 75 ohms. The RP model is recommended for up to 15 miles. Over a range of 15 to 25 miles, the RP +, which has a lower noise and higher gain RF amplifier stage, provides better television reception. These ranges are necessarily approximate, as signal strength is very sensitive to line of sight obstructions. For the Amateur builder Model CB converter board with trimmed oscillator is available. All models are **warranted for one year**.

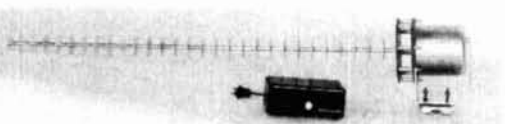

Prices including UPS shipment are as follows:

Model RP receiver package	\$135
Model RP + receiver package	\$155
Model CB converter board	\$50

K. & S. Enterprises

P.O. Box 741, Mansfield, MA 02048

UNARCO-ROHN

Self Supporting Towers On Sale!

During April these rugged beauties are being offered at Big Discounts and — we are shipping them **freight prepaid!** Look over the specifications and pick the unit most suited for your needs. Call us to place your order with Mastercard/Visa or write and include your check for quick shipment — **Freight Prepaid!**

Save even more — include antenna and rotor of your choice with the order and we will ship them along **freight prepaid** also! How's that for good old-fashioned savings?

FREIGHT PREPAID

Tower Model	Tower Ht.	Load Rating	Ship Weight	Tower Base	Tower Price	Base Price	Total Price
H8X40	40 ft	10 sq ft	164	BX86	269	24	293
H8X48	48 ft	10 sq ft	303	BX87	349	26	375
H8X56	56 ft	10 sq ft	385	BX88	419	30	449
HDBX40	40 ft	18 sq ft	281	BX87	313	26	339
HDBX48	48 ft	18 sq ft	363	BX88	399	30	429

Cushcraft

A3	\$169
A4	\$209

HYGAIN

TH3MK3	\$179
TH5DX	\$209
TH7DX	\$339

KLM

KT34A	\$319
KT34XA	\$479

Rotators

HD73	\$99
Ham IV	\$169
Tailtwister	\$239

ORDER TODAY!!

Offer Good 1 More Month Only

TEXAS TOWERS

A DIVISION OF TEXAS RF DISTRIBUTORS, INC.
1108 SUMMIT AVE., SUITE 4 — PLANO, TEXAS 75074
Mon.-Fri.: 8:30 a.m.-5:30 p.m. Saturday: 9:00 a.m.-1:00 p.m.
TELEPHONE: (214) 422-7306

THE LAST WORD IN READERS

THE NEW



MBA-RO



FEATURES:

- 32 CHARACTERS FOR EASY HIGH SPEED COPY OF MORSE
- ASCII and BAUDOT RTTY
- NO RECEIVER MODIFICATION NECESSARY
- INSTANT SPEED TRACKING FOR MORSE CODE OVER WIDE SPEED RANGE FROM 2 TO 99 WPM
- OPERATES FROM 12 V.D.C.

For AEA Readers or other AEA Products, call or visit:

AEA
Brings you the
Breakthrough!

Radios Unlimited

1760 Easton Avenue
Somerset, N.J. 08873
(201) 469-4599

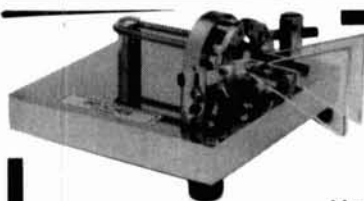

The New Standard... the Ultimate LAMBIC PADDLE

Modern CW technology at its best! Carefully engineered to make optimum use of today's keyers, the Bencher Lambic Paddle is a symphony of modern materials, design and workmanship. This is the paddle that provides the perfect interface between the CW operator and his rig. Smooth, instantly responsive and fully adjustable to suit your own touch. From the gold plated solid silver contacts to the heavy leaded steel base, it truly is the ultimate.

Standard \$42.95
Chrome \$52.95
Gold Plated \$150.00

At selected dealers or
add \$2.00 handling

Write:

BENCHER, INC.

333 W. Lake St., Chicago, IL 60606
(312) 263-1808

* Quality Microwave Systems 2100 to 2600 MHz Antennas 34 db Gain or Greater

Complete System (As Pictured) Ready to Install	\$149.95
Down Converter (Probe Mntd.) Assembled and Tested	64.95
Down Converter PCB (Chassis Mntd.) Assembled and Tested	64.95
Power Supply Assembled and Tested	59.95
Down Converter PCB (Chassis Mntd.) Kit w/ Parts and Data	49.95
Printed Circuit Board (Chassis Mntd.)	29.95
Data Information (Plans for Kit Building)	9.95

SEND CHECK, CASH, MONEY ORDER TO:

Phillips-Tech Electronics
P. O. Box 33205
Phoenix, Arizona 85067

For Special Quantity Pricing, C.O.D.'s, MasterCard or Visa Call:

(602) 274-2885

*Intended For Amateur Ham Use!

Attn: Recruiters

Expose Your Recruitment Ads to the most Technical Audience of Radio Hams Available

Here's how

Are you looking for a technically qualified person and find that few are available locally? Broaden your search by running an ad in HAM RADIO Magazine. HAM RADIO's readers are the most technically qualified. Over 60% are actively involved in one or more areas of the electronics industry. Their skills range from bench technician to design engineer. Here are some of the benefits from running an ad in HAM RADIO Magazine.

- National coverage at an affordable price
- Specially segmented audience
- Active Hams who do more than just read about electronics — they participate in it

Call today for more information about placing an ad in HAM RADIO. *Get the person you want!*

CALL TODAY
(603) 878-1441
Ham Radio
Box 0
Greenville, NH 03048

Tell 'em you saw it in HAM RADIO!

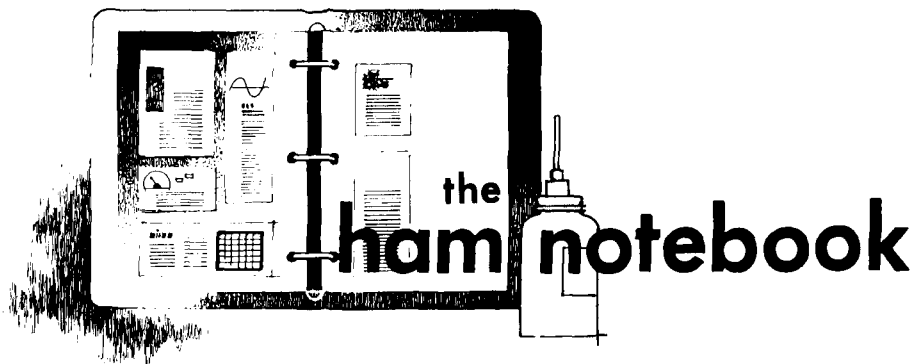

binary coded decimal addition

In the course of typical Amateur Radio do-it-yourself projects, you may seldom encounter a requirement for a binary adder. But if you should, the CD4008 is a logical choice if you prefer CMOS. However, the 4008 operates in pure binary format and is not intended to be used for BCD arithmetic.

I recently encountered the need to

add one binary coded decimal number to another. The requirement resulted from the desire to drive a seven-segment LED display from a BCD thumbwheel and also a divide-by- n IC in a frequency synthesizer. Sure enough, in true Murphy's Law fashion, these two requirements were not compatible — that is, unless a fixed BCD number was first added to the thumbwheel number for the divide-by- n circuit.

A search through all available

handbooks failed to identify an integrated circuit dedicated to adding in BCD. Rather than resorting to use of more exotic means to resolve this dilemma, such as by the use of a PROM for example, a combination of five readily available and inexpensive integrated circuits was assembled. What emerged is shown schematically in fig. 1. Despite the fact that the circuit shown is a hybrid combination of CMOS and TTL (they were available in the "goodie" box), from the first time power was applied, performance was flawless.

The operation of the BCD "adder" is as follows:

Assume that initially the Q outputs of the 4029 counter agree bit-for-bit with the thumbwheel output bits at the comparator input terminals. This sets the 74LS85 $A = B$ output high, which in turn prevents clock pulses from reaching the 4029 counter. This is a static situation that will persist

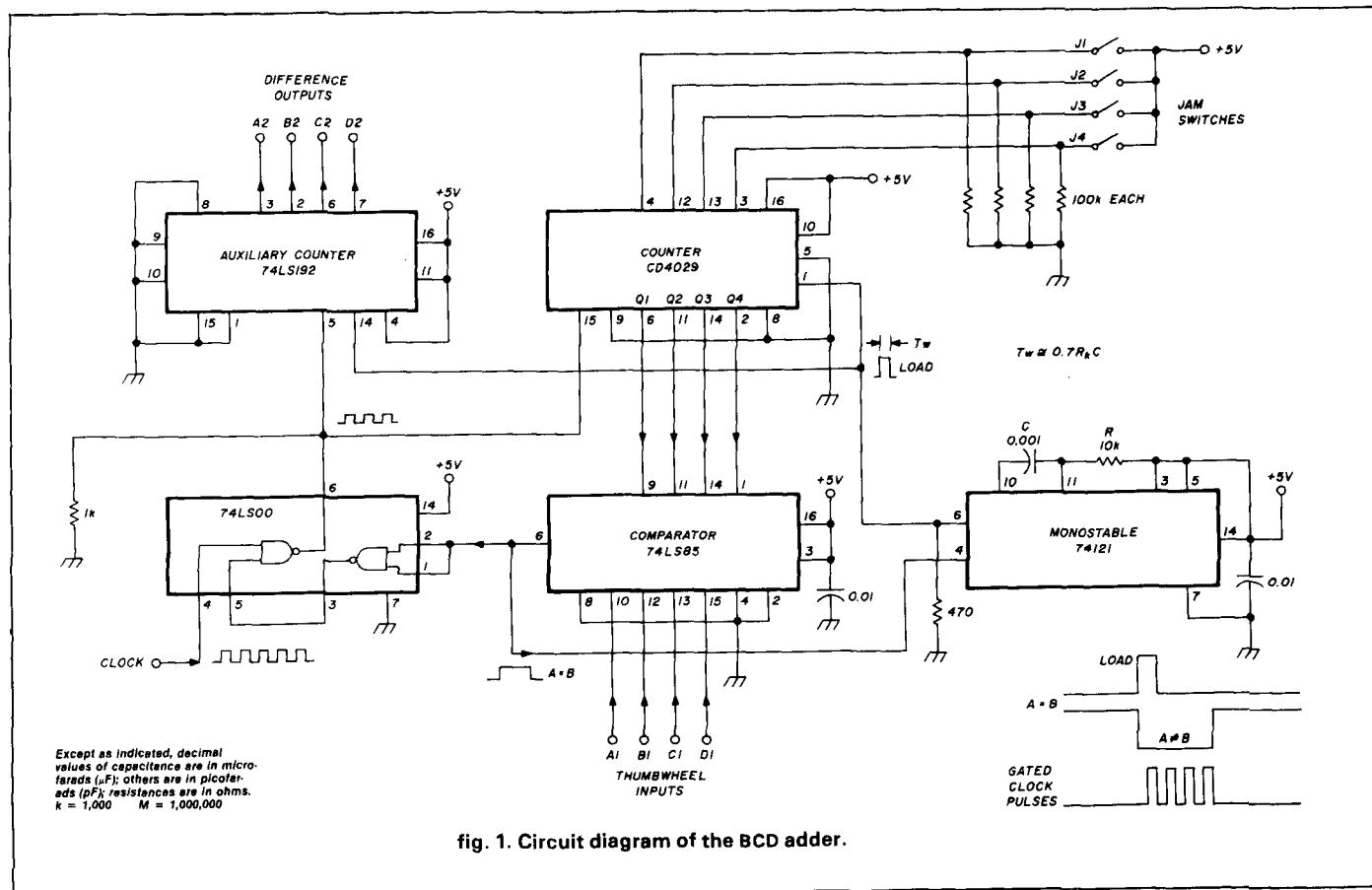

fig. 1. Circuit diagram of the BCD adder.

until such time as the thumbwheel switch setting is changed.

When the thumbwheel setting is changed, the falling edge of $A = B$ activates the 74121 monostable, which in turn generates a single LOAD or PRESET-ENABLE pulse. This pulse presets the 4029 counter so that its Q outputs agree with the JAM inputs. In other words, instead of being reset to zero, the counter is preset to some binary number equal to or greater than zero, according to the settings of the JAM switches.

At the same time, the comparator $A = B$ output is LOW, and the NAND gate is open, allowing clock pulses to reach the 4029 input terminal. Thereafter, the 4029 Q outputs change, starting from their preset values, until they again agree with the thumbwheel bits. At this time, the comparator's $A = B$ output goes high, thus interrupting the train of clock pulses and freezing the contents of the counter.

The number of clock pulses necessary to re-establish this static $A = B$ state depends upon the difference between the thumbwheel number and the JAM number. If, for example, the number nine (1001) is dialed, and the JAM number selected is three (0011), the number of clock pulses gated to the 4029 counter will be $1001 - 0011 = 0110$ ($9 - 3 = 6$).

The gated pulses are also fed to an auxiliary counter, a 74LS192, which has its DATA inputs hard-wired to zero. Each time it receives a LOAD pulse from the monostable, it will reset to zero and accumulate a count numerically equal to the number of the clock pulses in the train. In the example above, the 74LS192 Q outputs will read 0110, or six, after being reset to zero, which is exactly the desired result.

The 74LS192 provides a difference output equal to the thumbwheel number minus the JAM number. Would it not therefore be more appropriate to call this circuit a SUBTRACTOR? After all, it's the difference that counts.

Norman J. Foot, WA9HUV



NEW ... \$139.95

NEW MORSEMATIC™ MM-2 KEYSER

THE MORSEMATIC KEYSER BY AEA HAS BEEN PROCLAIMED BEST OF ALL PADDLE KEYSERS ON THE MARKET

Now you can get all the features of the world's first and still best microcomputerized keyer at a 30% reduction in price. The new model MM-2 has all the outstanding features of the MM-1 predecessor such as dual microcomputers with copywritten software, 500 character soft-partitioned™ memory with editing, exclusive beacon mode, exclusive automatic speed increase trainer mode, and exclusive automatic serial number generator. In addition, the MM-2 comes complete with CMOS memory and provisions for internal memory keep alive battery. The MM-2 operates from external 12 VDC at approximately 350 Ma.

ACCESSORIES:

Model AC-1 600 Ma 12 VDC Wall Adaptor \$14.95
Model ME-2 Memory Expansion (2000 Total Morse Characters) \$39.95

If you have hesitated buying the best because of price, you need to wait no longer, the best is now available in an improved form at a price you can afford.

PRICES AND SPECIFICATIONS SUBJECT TO CHANGE WITHOUT NOTICE

call or visit:

AEA
Brings you the
Breakthrough!

G & K Amateur Supply

2920 East 9th Street
Des Moines, Iowa 50316
(515) 262-1745

Take your favorite H.T. out for a drive tonight.

VISA or MASTERCARD for same day shipment.

For \$69.95 you get the most efficient, dependable, fully guaranteed 35W 2 meter amp kit for your handy talkie money can buy.

Now you can save your batteries by operating your H.T. on low power and still get out like a mobile rig. The model 335A produces 35 watts out with an input of 3 watts, and 15 watts out with only 1 watt in. Compatible with IC-2AT, TR-2400, Yaesu, Wilson & Tempo! Other 2 meter models are available with outputs of 25W and 75W, in addition to a 100W amplifier kit for 430MHZ.

Communication Concepts Inc. 2648 N. Aragon Ave., Dayton, OH 45420 (513) 296-1411



It's Incredible!

Now You Can...

Master code or upgrade in a matter of days! Code Quick is a unique breakthrough to revolutionize the learning of Morse Code. Instead of an endless maze of dits and dahs, each letter will magically begin to call out its own name! Stop torturing yourself with old-fashioned methods. Your amazing kit contains 5 power-packed cassettes, visual breakthrough cards, and original manual. All this for only \$39.95! Send check or money order today to WHEELER APPLIED RESEARCH LAB, P.O. Box 3261, City of Industry, CA 91744. Ask for Code Quick #107. California residents add 6% sales tax.

You can't lose! Follow each simple step. You must succeed or return the kit for total immediate refund!



GROTH-Type

COUNTS & DISPLAYS YOUR TURNS

- 99.99 Turns
- One Hole Panel Mount
- Handy Logging Area
- Spinner Handle Available

Case: 2x4"; shaft 1/4"x3"

TC2 \$10.00

TC3 \$11.00

Spinner Handle Add \$1.50

Prices include UPS or Parcel Post

Model TC2: Skirt 2-1/8"; Knob 1-5/8"

Model TC3: Skirt 3"; Knob 2-3/8"

R. H. BAUMAN SALES

P.O. Box 122, Itasca, Ill. 60143

HAL'S SEE YOU AT DAYTON



- HAL 2304 MHz DOWN CONVERTERS (FREQ. RANGE 2000/2500 MHz)**
- 2304 MODEL #1 KIT** BASIC UNIT W/PREAMP LESS HOUSING & FITTINGS \$49.95
 - 2304 MODEL #2 KIT** (with preamp) \$59.95
 - 2304 MODEL #3 KIT** (with High Gain preamp) \$69.95

MODELS 2 & 3 WITH COAX FITTINGS IN & OUT AND WITH WEATHER-PROOFED DIE CAST HOUSINGS.

- FACTORY WIRED & TESTED \$50 additional
- BASIC POWER SUPPLY \$19.95
- POWER SUPPLY KIT FOR ABOVE WITH CASE \$24.85
- FACTORY WIRED & TESTED \$34.95

ANTENNAS & OTHER ACCESSORIES AVAILABLE. SEND FOR MORE INFO.

COMPLETE KITS: CONSISTING OF EVERY ESSENTIAL PART NEEDED TO MAKE YOUR COUNTER COMPLETE. **HAL-600A** 7-DIGIT COUNTER WITH FREQUENCY RANGE OF ZERO TO 600 MHZ. FEATURES TWO INPUTS: ONE FOR LOW FREQUENCY AND ONE FOR HIGH FREQUENCY. AUTOMATIC ZERO SUPPRESSION. TIME BASE IS 1.0 SEC OR .1 SEC GATE WITH OPTIONAL 10 SEC GATE AVAILABLE. ACCURACY ±.001%. UTILIZES 10-MHZ CRYSTAL 5 PPM. **COMPLETE KIT \$129**

HAL-300A 7-DIGIT COUNTER (SIMILAR TO 600A) WITH FREQUENCY RANGE OF 0-300 MHZ. **COMPLETE KIT \$109**

HAL-50A 8-DIGIT COUNTER WITH FREQUENCY RANGE OF ZERO TO 50 MHZ OR BETTER. AUTOMATIC DECIMAL POINT. ZERO SUPPRESSION UPON DEMAND. FEATURES TWO INPUTS: ONE FOR LOW FREQUENCY INPUT, AND ONE ON PANEL FOR USE WITH ANY INTERNALLY MOUNTED HALTRONIX PRE-SCALER FOR WHICH PROVISIONS HAVE ALREADY BEEN MADE. 1.0 SEC AND .1 SEC TIME GATES. ACCURACY ±.001%. UTILIZES 10-MHZ CRYSTAL 5 PPM. **COMPLETE KIT \$109**

FREE: HAL-79 CLOCK KIT PLUS AN INLINE RF PROBE WITH PURCHASE OF ANY FREQUENCY COUNTER.

PRE-SCALER KITS

- HAL 300 PRE** (Pre-drilled G-10 board and all components) \$14.95
- HAL 300 A/PRE** (Same as above but with preamp) \$24.95
- HAL 600 PRE** (Pre-drilled G-10 board and all components) \$29.95
- HAL 600 A/PRE** (Same as above but with preamp) \$39.95

TOUCH TONE DECODER KIT

HIGHLY STABLE DECODER KIT. COMES WITH 2 SIDED, PLATED THRU AND SOLDER FLOWED G-10 PC BOARD, 7-567's, 2-7402, AND ALL ELECTRONIC COMPONENTS. BOARD MEASURES 3-1/2 x 5-1/2 INCHES. HAS 12 LINES OUT. ONLY **\$39.95**

NEW - 16 LINE DELUXE DECODER \$69.95

DELUXE 12-BUTTON TOUCHTONE ENCODER KIT UTILIZING THE NEW ICM 7206 CHIP. PROVIDES BOTH VISUAL AND AUDIO INDICATIONS! COMES WITH ITS OWN TWO-TONE ANODIZED ALUMINUM CABINET. MEASURES ONLY 2-3/4" x 3-3/4". COMPLETE WITH TOUCH-TONE PAD. BOARD, CRYSTAL, CHIP AND ALL NECESSARY COMPONENTS TO FINISH THE KIT. **PRICED AT \$29.95**

NEW - 16 LINE DELUXE ENCODER \$39.95

ACCUKEYER (KIT) THIS ACCUKEYER IS A REVISED VERSION OF THE VERY POPULAR WB4VVF ACCUKEYER ORIGINALLY DESCRIBED BY JAMES GARRETT, IN QST MAGAZINE AND THE 1975 RADIO AMATEUR'S HANDBOOK. **\$16.95**

ACCUKEYER - MEMORY OPTION KIT PROVIDES A SIMPLE, LOW COST METHOD OF ADDING MEMORY CAPABILITY TO THE WB4VVF ACCUKEYER. WHILE DESIGNED FOR DIRECT ATTACHMENT TO THE ABOVE ACCUKEYER, IT CAN ALSO BE ATTACHED TO ANY STANDARD ACCUKEYER BOARD WITH LITTLE DIFFICULTY. **\$16.95**

BUY BOTH THE MEMORY AND THE KEYS AND SAVE. COMBINED PRICE ONLY \$32.00

PRE-AMPLIFIER

HAL-PA-10 WIDE BAND. PRE-AMPLIFIER, 2-200 MHZ BANDWIDTH (-3dB POINTS), 19 dB GAIN. **FULLY ASSEMBLED AND TESTED \$8.95**



CLOCK KIT - HAL 79 FOUR-DIGIT SPECIAL - \$7.95. OPERATES ON 12-VOLT AC (NOT SUPPLIED). PROVISIONS FOR DC AND ALARM OPERATION

6-DIGIT CLOCK • 12/24 HOUR

COMPLETE KIT CONSISTING OF 2 PC G-10 PRE-DRILLED PC BOARDS, 1 CLOCK CHIP, 6 FND COMM. CATH. READOUTS, 13 TRANS., 3 CAPS, 9 RESISTORS, 5 DIODES, 3 PUSH-BUTTON SWITCHES, POWER TRANSFORMER AND INSTRUCTIONS. DON'T BE FOOLED BY PARTIAL KITS WHERE YOU HAVE TO BUY EVERYTHING EXTRA. **PRICED AT \$12.95**

CLOCK CASE AVAILABLE AND WILL FIT ANY ONE OF THE ABOVE CLOCKS. REGULAR PRICE . . . \$6.50 BUT ONLY **\$4.50 WHEN BOUGHT WITH CLOCK.**

SIX-DIGIT ALARM CLOCK KIT FOR HOME, CAMPER, RV, OR FIELD-DAY USE. OPERATES ON 12-VOLT AC OR DC, AND HAS ITS OWN 60-Hz TIME BASE ON THE BOARD. COMPLETE WITH ALL ELECTRONIC COMPONENTS AND TWO-PIECE, PRE-DRILLED PC BOARDS. BOARD SIZE 4" x 3". COMPLETE WITH SPEAKER AND SWITCHES. IF OPERATED ON DC, THERE IS NOTHING MORE TO BUY. **PRICED AT \$16.95**

*TWELVE-VOLT AC LINE CORD FOR THOSE WHO WISH TO OPERATE THE CLOCK FROM 110-VOLT AC. **\$2.50**

SHIPPING INFORMATION - ORDERS OVER \$25.00 WILL BE SHIPPED POSTPAID EXCEPT ON ITEMS WHERE ADDITIONAL CHARGES ARE REQUESTED. ON ORDERS LESS THAN \$25.00 PLEASE INCLUDE ADDITIONAL \$2.00 FOR HANDLING AND MAILING CHARGES. SEND SASE FOR FREE FLYER.

DISTRIBUTOR FOR
Aluma Tower • AP Products
(We have the new Hobby-Blox System)

HAL-TRONIX

P. O. BOX 1101
SOUTHGATE, MICH. 48195
PHONE (313) 285-1782



Computer Program Books for Beginners

Everything you need to know to get started programming your own computer. These handy books of programs, each jam-packed with easy-to-understand info for beginners, are crammed with hundreds of tips, tricks, secrets, hints, shortcuts, techniques, plus hundreds of tested ready-to-run programs. For the TRS-80 Color Computer. For the TRS-80 Pocket Computer and Sharp PC-1211, PC-1500 pocket computers.

Color Computer

- 101 Color Computer Programming Tips & Tricks**, learn-by-doing instructions, hints, secrets, shortcuts, techniques, insights, for TRS-80 Color Computer, 128 pages **\$7.95**
- 55 Color Computer Programs for Home, School & Office**, practical ready-to-run software with colorful graphics for TRS-80 Color Computer, 128 pages. **\$9.95**
- 55 MORE Color Computer Programs for Home, School & Office**, sourcebook of useful type-in-and-run software with exciting graphics, for TRS-80 Color Computer, 112 pages. **\$9.95**

Pocket Computer

- Pocket Computer Programming Made Easy**, new fast 'n easy way to learn BASIC, make your computer work for you, for TRS-80, Sharp, Casio pocket computers, 128 pages. **\$8.95**
- 101 Pocket Computer Programming Tips & Tricks**, secrets, hints, shortcuts, techniques from a master programmer, 128 pages **\$7.95**
- 50 Programs in BASIC for Home, School & Office**, sourcebook of tested ready-to-type-in-and-run software for TRS-80 and Sharp pocket computers, 96 pages **\$9.95**
- 50 MORE Programs in BASIC for Home, School & Office**, ideal source for lots more useful software for TRS-80 and Sharp pocket computers, 96 pages. **\$9.95**
- Murder in The Mansion and Other Computer Adventures**, with 24 game programs: murder mystery, space, adventure, loads of fun for TRS-80 and Sharp pocket computers, 96 pages. **\$6.95**

QTY.	Title	Price	Total

Allow 2-4 weeks for delivery.

SHIPPING **\$2.00**
TOTAL

FROM:

Name _____ Call _____
Address _____
City _____ State _____ Zip _____

Check or Money Order Enclosed
 VISA MasterCard

Acct. # _____
Expires _____ MC Bank # _____

**SEND TO: HAM RADIO'S BOOKSTORE
GREENVILLE, NH 03048**

UNIVERSAL COMMUNICATIONS

A Division of
Innovative Labs, Inc.

For information or ordering
(817) 860-1641

MC, VISA, Phone or Mail Orders Accepted.
Hours, 8:30-4:30 CST; Mon.-Fri.

VIDEO STABILIZER KIT

Video Stabilizers are used to eliminate rolling and unviewable pictures when viewing pre-recorded video tapes. A must for all VCR owners.

TMVS-1 Kit \$55.00

Assembled and Tested \$70.00
For use between two VCRs.

TMVS-IRF Kit \$79.00

Assembled and Tested \$99.00
Built-in RF modulator for direct connection from VCR to TV.

SUPERVERTER I KIT \$99.95

The ultimate in converter technology! Dual stage selective preamp, mixer, i.f. amplifier and no-drift crystal controlled oscillator. We recommend this kit for the experienced kit builder. No crystal supplied.

Without preamp \$59.95

Superverter I built and tested \$149.95

12 V. Stationary Power Supply \$24.95

SELECTIVE PREAMP \$39.95

This new unit is not like other wide band preamps. Experienced kit builders can easily add this unit to our existing boards or to other manufactured boards to improve overall performance.

2300 MHz Downconverter \$35.00

PC Board, all components and instructions for a working unit.

VARIABLE POWER SUPPLY \$24.95

Complete kit includes all components for working unit including deluxe box and overlays.

DISH YAGI ANTENNA \$25.00

Complete kit with PVC and mounting brackets. Stronger than loop yagi, equal in gain.

KD44 Antenna \$54.95

Overall 25 dB gain. Partial assembly required. Shipped UPS ground only.

Our product may be copied, but the performance is never equaled.

UNIVERSAL COMMUNICATIONS P.O. Box 339
Arlington, TX 76004-0339

MOBILE TOWERS by ALUMA

FOR MOBILE VAN, TRUCK OR TRAILERS.
USE FOR COMMUNICATION OR CHECK YOUR SIGNALS.

HIGHEST QUALITY ALUMINUM & STEEL

- TELESCOPING Crank-Ups to 100 ft.
- TILT-OVER MODELS Easy to install. Low Prices.

EXCELLENT FOR HAM COMMUNICATIONS

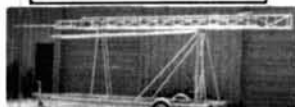

Mobile Trailer Type



Mobile Truck Type

Mobile Van Type

Over 36 types aluminum and steel towers made—specials designed and made—write for details.

ALUMA TOWER COMPANY
BOX 2806HR
VERO BEACH, FLA. 32960
(305) 567-3423 TELEX 80-3405

LARUE ELECTRONICS ICOM HEADQUARTERS

ICOM TRANSCEIVERS: IC-2A, IC-2AT, IC-3AT, IC-22U, IC-25A, IC-202S, IC-251A, IC-255A, IC-280, IC-290A, IC-551D, IC-560, IC-720A AND IC-730. ICOM ACCESSORIES: IC-3PE POWER SUPPLY \$95.00. IC-PS15 AND IC-PS20 POWER SUPPLIES. IC-SP2 AND IC-SP3 MATCHING BASE STATION EXTERNAL SPEAKERS, \$49.50 EACH. BC-15 NI-CAD BATTERY PACK AND AC WALL CHARGER FOR IC-202S AND IC-402 \$57.50. BC-20 NI-CAD BATTERY PACK AND DC/DC CHARGER FOR IC-202S, IC-215, IC-402 AND IC-502A \$57.50. IC-AH1 HF 5-BAND [10 THROUGH 80 METERS] MOBILE ANTENNA WITH ANTENNA TUNER. IC-CF1 COOLING FAN FOR IC-PS20 POWER SUPPLY \$45.00. IC-HP1 HEADPHONES [4 TO 16 OHMS] \$34.50. IC-HM8 TONE ENCODER 8-PIN MICROPHONE FOR IC-22U, IC-25A, IC-251A, IC-255A, IC-260A AND IC-290A \$49.50. IC-HM10 SCANNING/SEARCH MICROPHONE FOR IC-25A, IC-255A, IC-260A, IC-290A AND IC-730 \$39.50. IC-SM2 ELECTRET CONDENSER GOOSENECK BASE MICROPHONE FOR ANY ICOM 4-PIN MICROPHONE RADIO \$39.00. IC-SM5 ELECTRET CONDENSER GOOSENECK BASE MICROPHONE FOR ANY ICOM 8-PIN MICROPHONE RADIO \$39.00. ICOM HANDHELD TRANSCEIVER ACCESSORIES: BC-30 DROP-IN RAPID BATTERY CHARGER \$69.00. IC-BP2 NI-CAD BATTERY PACK \$39.50. IC-BP3 NI-CAD BATTERY PACK \$29.50. IC-BP4 EMPTY BATTERY CASE \$12.50. IC-BP5 NI-CAD BATTERY PACK \$49.50. IC-CP1 MOBILE CHARGING CORD \$9.50. IC-DC1 DC REGULATOR \$17.50. IC-HM9 SPEAKER/MICROPHONE \$34.50. LEATHER CARRYING CASE [FOR TOUCH-TONE MODELS] \$34.95. ICOM IC-720A ACCESSORIES: FL-32 NARROW CW FILTER \$59.50. FL-34 NARROW AM FILTER \$49.50. ICOM IC-730 ACCESSORIES: IC-EX202 LDA-2 UNIT FOR AUTOMATIC BAND SWITCHING [WHEN USING THE IC-AT100/AT500, IC-AH1 OR IC-2KL] \$27.50. IC-EX203 NARROW CW AUDIO FILTER \$39.00. FL-30 SSB PASSBAND TUNING CRYSTAL FILTER \$59.50. FL-45 NARROW CW CRYSTAL FILTER \$59.50. ICOM IC-720A/IC-730 MOBILE MOUNTING BRACKETS, \$19.50 EACH. 73, L. GENE LARUE K3HAM.

Larue Electronics, 1112 GRANDVIEW STREET, SCRANTON, PA. 18509 - Ph. [717]343-2124

RTTY RADIOTELETYPE FREQUENCY LISTS

Worldwide Radioteletype Stations by frequency. 2000 Stations. Press: Air Military Diplo. Government all utilities listed with call: times plus other info. 3 to 30 MHz \$12.00 P.P.
World Press Services Frequencies and Manual All press services, freq. and transmission times. Book with 3 lists \$8.00 P.P.
Universal Electronics, 1280 Aida Dr., Reynoldsburg, Ohio 43068

AZDEN DISCOUNT PRICE

- Azden PCS 3000 (2 meter FM)
- 6 amp fully reg power supply \$46.00

Order 24 hours a day (215) 884-6010
FREE UPS - N.P.S. Inc. WA31FQ
1138 BOXWOOD RD., JENKINTOWN, PA. 19046

R-4C+SHERWOOD CRYSTAL FILTERS

STILL THE FINEST COMBINATION

600 HZ LOW-LOSS 1st-IF CW FILTER. Improve early-stage selectivity. Eliminate high-pitched leakage around 2nd-IF filters. Improve ultimate rejection to 140 dB. Eliminate strong signals overloading 2nd mixer, causing intermod and desensitization. CF-600/6: \$80.00. New PC board relay switch kit: \$45.00.
16-POLE R-4C SSB! Optimum bandwidth plug-in filter. Unexcelled skirt selectivity. Low loss. 1800 Hz at 6 dB, 2400 Hz at 60 dB. CF-2K/16: \$135.00.
250 AND 500 HZ 8-POLE 2nd-IF PLUG-IN FILTERS. CF-250/8, CF-500/8: \$80.00.
1st-IF SSB FILTERS still available. CF-2K/8: \$150.00 pair. SPECIAL AM FILTERS and switching kits available.
Filters also available for R-7, TR-7, TR-4, Signal/One, Atlas. Add \$3 shipping per order; \$6 overseas air.
Europeans: Please contact Ingoimpex, Postfach 24 49, D-8070, Ingolstadt, West Germany.

Sherwood Engineering Inc.

1268 South Ogden St.
Denver, Colo. 80210
(303) 722-2257



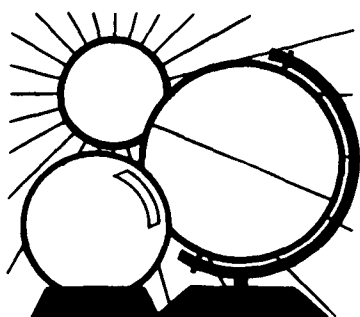

DX FORECASTER

Garth Stonehocker, KØRYW

last-minute forecast

April brings a continuation of equinoctial propagation conditions and so could be a ball — remember last year's March and April? One cannot expect a duplication of last year, but be prepared to take advantage of the situation because there is good probability that something will happen. The sun/earth alignment makes for maximum ionospheric effect from solar wind particles released from the sun. The periods in April that look good for geomagnetic disturbances and erratic ionospheric movements are around the 10th, 19th, and 29th. These last two are associated with periods of solar flares and a 27-day solar activity maximum.

For the first week and a half of the forecast period the lower bands will probably be the best for DX. The higher bands are expected to improve the last weeks of the month both for trans-equatorial paths and north/south paths. North/south paths are enhanced the day or two before a disturbance; then the trans-equatorial paths are enhanced during the disturbance. The former is hard to recognize except by the presence of very low A and K geomagnetic indexes and by the use of beacons (see last month's DX Forecaster).

Other geophysical phenomena which may be of interest to DXers this month are the moon and meteor showers. The perigee of the moon's orbit (for moon-bounce DX) is on the 25th at 2100 hours; the moon will be at full phase on the 8th at 1018 hours. There will be short meteor shower, the Lyrid, on April 20-22. The rate is five per hour, hardly a real help for meteor-scatter DX. But a bigger shower, the Aquarid, starts before the end of the month, peaks on May 5, and ends by mid May. Its rate is 10 to 30 per hour.

Let's take a look at last year's spring equinox DX season. Using 6-meter contacts reported to *HR Report* as an indicator of good DX conditions, let's check on the openings and accompanying solar and geomagnetic conditions. With the solar flux above 240 and a mild geomagnetic disturbance in progress on February 28, a dip in the flux increased the disturbance so that a southern Africa to northern Europe trans-equatorial path opened up. At the same time, Liberia to the southwestern U.S.A. in a low-latitude east/west path was also good. On March 1st and 2nd other trans-equatorial paths from southern Africa to Europe and South America to the U.S. were open. After a quiet 3rd and 4th, a

large disturbance with aurora arrived on the 5th and 6th with Columbia/Caribbean stations working into the U.S. On March 7th, the South America to Japan path was a big trans-equatorial opening.

The next disturbance, on March 13-15, found Ascension Island making over one hundred Japanese contacts; the flux was still above 200. Argentina and Chile had trans-equatorial openings all three days. There were good DX openings between Australia/New Zealand and the U.S. on the 14th and 16th. By the 21st and 22nd, the mid-latitude ionosphere was enhanced just before the commencement of the March 24-26 disturbance at low solar flux; east/west paths from the U.S. to Liberia, from Southern Africa to Hawaii, and from Canada/the Caribbean/French Guiana to Japan were open. The disturbance was very effective on the 26th between Southern Africa and Europe and between Australia/New Zealand and the Caribbean as the flux came back up above 200 again. LU3EX worked 550 JAs during the first half of March.

On the 6th of April the southern Africa/Hawaii path came alive again as the solar flux peaked on up to 276. From April 11 to 14 there was such a big storm most DX was wiped out, but a lesser disturbance on April 19-21 had French Guiana working Australia and southern Africa at the same time. Mexico worked Australia and New Zealand. The solar flux was about 200 during this disturbance. You can see how our solar-ionosphere connection really gives our DX hobby its interesting openings. Some geophysical rules of thumb, WWV flux and geomagnetic values, and beacons to use as tools can enhance the fun. Good DXing this month.

band-by-band forecast

Six meters should provide frequent band openings with a peak during the early afternoon hours on many days.

(Continued on page 72)

WESTERN USA

GMT	PST	N	NE	E	SE	S	SW	W	NW
0000	4:00	10	15	10	10	10	10	10	15
0100	5:00	10	20	10	10	10	10	10	15*
0200	6:00	10	20	15	10	10	10	10	15
0300	7:00	10	20	15	10	15	10	10	15
0400	8:00	15	20	15	20	15	15	10	15
0500	9:00	15	20*	15	20	15	15	15*	15
0600	10:00	20	20	15	20	20	15	15	20*
0700	11:00	20	20*	20	20	20	15	15	20*
0800	12:00	20	20	20	20	20	20	20	20
0900	1:00	20	20	20	20	20	20	20	20
1000	2:00	20	20	20	20	40*	20	20	20
1100	3:00	20	20	20	20	40	40	20	20
1200	4:00	20	20	20	20	40	40	20	20
1300	5:00	20	20	20	20	40	40	20	20
1400	6:00	20	15	20	15	20	20	20	20
1500	7:00	20	15	20	15	20	20	20	20
1600	8:00	15	15	20	10	20	40*	20	20
1700	9:00	15	15	20	10	20	40*	20	20
1800	10:00	15	15	15*	10	20	20	20	20
1900	11:00	15	15	15	10	15	15	10	15
2000	12:00	15	15	15	10	10	15	10	15
2100	1:00	15	15	15	10	10	10	15	15
2200	2:00	15	15	15	10	10	10	10	15
2300	3:00	10	15	15	10	10	10	10	15

MID USA

GMT	MST	N	NE	E	SE	S	SW	W	NW
0000	5:00	15	20*	10	10	10	10	10	15
0100	6:00	15	20	15	10	15	15*	15	10
0200	7:00	15	20	15	10	15	15	15	10
0300	8:00	15	20	15	10	15	15	15	15
0400	9:00	15	20	15	10	15	15	15	15
0500	10:00	20	20	15	15	20	15	15	15
0600	11:00	20	20	15	15	20	15	15	15
0700	12:00	20	20	15	15	20	15	15	15
0800	1:00	20	20	15	15	20	15	15	15
0900	2:00	20	20	15	15	20	15	15	15
1000	3:00	20	20	15	15	20	15	15	15
1100	4:00	20	20	15	15	20	15	15	15
1200	5:00	20	20	15	15	20	15	15	15
1300	6:00	20	20	15	15	20	15	15	15
1400	7:00	20	20*	15	15	20	15	15	15
1500	8:00	20	20*	15	15	20	15	15	15
1600	9:00	20	20*	15	15	20	15	15	15
1700	10:00	15	15	15	10	20	15	15	15
1800	11:00	15	15	15*	10	15	15	15	15
1900	12:00	15	15	15*	10	10	15	15	15
2000	1:00	15	15	15	10	10	15	15	15
2100	2:00	15	15	15	10	10	10	15	15
2200	3:00	15	15	15	10	10	10	15	15
2300	4:00	15	15	15	10	10	10	15	15

EASTERN USA

GMT	EST	N	NE	E	SE	S	SW	W	NW
0000	7:00	15	15	10	10	15	15	10	10
0100	8:00	15	15	15	10	15	15	10	15
0200	9:00	15	15	15	10	15	15	10	15
0300	10:00	15	15	15	10	15	15	10	15
0400	11:00	15	15	15	10	15	15	10	15
0500	12:00	15	15	15	10	15	15	10	15
0600	1:00	15	15	15	10	15	15	10	15
0700	2:00	15	15	15	10	15	15	10	15
0800	3:00	15	15	15	10	15	15	10	15
0900	4:00	15	15	15	10	15	15	10	15
1000	5:00	15	15	15	10	15	15	10	15
1100	6:00	15	15	15	10	15	15	10	15
1200	7:00	15	15	15	10	15	15	10	15
1300	8:00	15	15	15	10	15	15	10	15
1400	9:00	15	15	15	10	15	15	10	15
1500	10:00	15	15	15	10	15	15	10	15
1600	11:00	15	15	15	10	15	15	10	15
1700	12:00	15	15	15	10	15	15	10	15
1800	1:00	15	15	15	10	15	15	10	15
1900	2:00	15	15	15	10	15	15	10	15
2000	3:00	15	15	15	10	15	15	10	15
2100	4:00	15	15	15	10	15	15	10	15
2200	5:00	15	15	15	10	15	15	10	15
2300	6:00	15	15	15	10	15	15	10	15

*Look at next higher band for possible openings.

WARNING

SAVE YOUR LIFE OR AN INJURY

Base plates, flat roof mounts, hinged bases, hinged sections, etc., are not intended to support the weight of a single man. Accidents have occurred because individuals assume situations are safe when they are not.

Installation and dismantling of towers is dangerous and temporary guys of sufficient strength and size should be used at all times when individuals are climbing towers during all types of installations or dismantlings. Temporary guys should be used on the first 10' or tower during erection or dismantling. Dismantling can even be more dangerous since the condition of the tower, guys, anchors, and/or roof in many cases is unknown.

The dismantling of some towers should be done with the use of a crane in order to minimize the possibility of member, guy wire, anchor, or base failures. **Used towers in many cases are not as inexpensive as you may think if you are injured or killed.**

Get professional, experienced help and read your Rohn catalog or other tower manufacturers' catalogs before erecting or dismantling any tower. A consultation with your local, professional tower erector would be very inexpensive insurance.

Paid for by the following:

UNR-Rohn
Division of UNR, Inc.
6718 West Plank Road
Peoria, Illinois 61601
USA

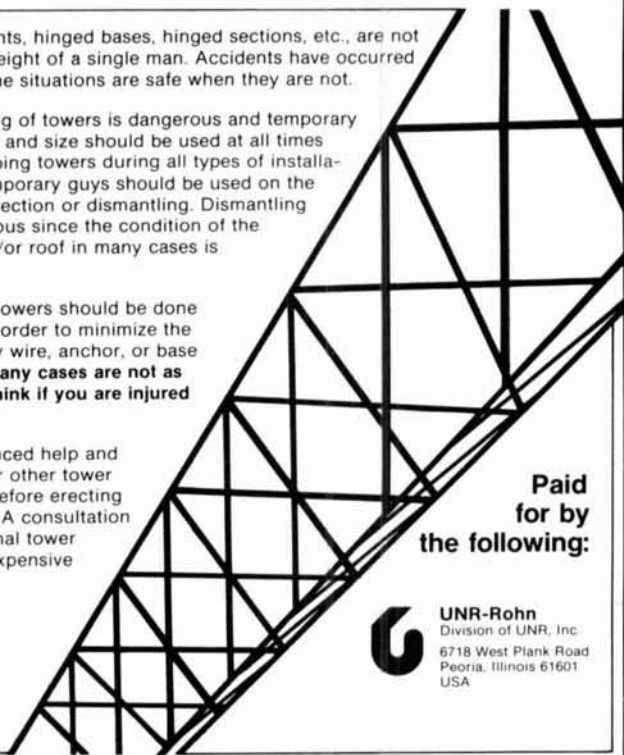

Trans-equatorial north/south paths will be the best. Your guide to possible openings will be strong openings on 10 meters and high values of solar flux.

Ten and fifteen meters will be loaded with good DX signals from morning until early evening hours almost every day. Times of geomagnetic disturbance will limit the number of signals heard, but listen carefully — they can be from very unusual places. Fifteen meters should be open later in the day than 10 meters. So hit 10 first and finish off with 15. The lengthening of the daylight will be noticed as these bands open up a little sooner and stay open longer in the day.

Twenty meters will be the main daytime DX band, as it is almost always open to some part of the world. It opens to the east as the sun rises and extends into the late evening hours to the west. Geomagnetic disturbances do not affect this band as much as the higher ones, but still look for unusual trans-equatorial DX locations to be coming through once in a while. One-hop trans-equatorial DX of 5,000 to 7,000 miles (8,000 to 11,200 km) may be possible in the late evening hours during some of these unusual conditions.

Forty and eighty meters will have short skip during daylight hours and turn to DX after dark. The bands will open to the east soon after sundown, swing more to the south to Latin America about midnight, and end up to the Pacific areas during the hour or so before dawn. On some nights these bands will be as good as during the winter DX season. The coastal regions usually have the edge for working rare DX on these bands.

One-sixty meters will probably have many nights that will remind you of last summer's noise. However many good nights are left for working DX before this summer's noise comes to stay. Many stateside stations are fair game as DX on this band during this season.

ham radio

Radio World

CENTRAL NEW YORK'S MOST COMPLETE HAM DEALER

ROBOT 800

ICOM IC-720

KENWOOD TS830S

DRAKE TR7 DR7

YAESU FT707

Featuring Kenwood, Yaesu, Icom, Drake, Ten-Tec, Swan, Dentron, Alpha, Robot, MFJ, Tempo, Astron, KLM, Hy Grain, Mosley, Larsen, Cushcraft, Hustler, Mini Products, Bird, Mirage, Vibroplex, Bencher, Info-Tech, Universal Towers, Callbook, ARRL, Astatic, Shure, Collins, AEA. *We service everything we sell!*

Write or call for quote. **You Won't Be Disappointed.**

We are just a few minutes off the NYS Thruway (I-90) Exit 32

OUT OF STATE
ORDER TOLL FREE
800-448-9338

ONEIDA COUNTY AIRPORT TERMINAL BUILDING
ORISKANY, NEW YORK 13424
N.Y. Res. Call (315) 736-0184

Warren - K2IXN
Bob - WA2MSH
Al - WA2MSI

SYNTHESIZED
SIGNAL GENERATOR

MODEL
SG1000
\$349.95
plus shipping

MADE IN USA

- Covers 100 to 185 MHz in 1 kHz steps with thumb-wheel dial
- Accuracy 1 part per 10 million at all frequencies
- Internal FM adjustable from 0 to 100 kHz at a 1 kHz rate
- Spurs and noise at least 60 dB below carrier
- RF output adjustable from 5-500 mV at 50 ohms
- Operates on 12 Vdc @ 1/2 Amp
- Available for immediate delivery • \$349.95 plus shipping
- Add-on Accessories available to extend frequency range, add infinite resolution, voice and sub-audible tones, AM, precision 120 dB calibrated attenuator
- Call for details • Dealers wanted worldwide.

VANGUARD LABS
196-23 Jamaica Ave., Hollis, NY 11423
Phone: (212) 468-2720

SEND FOR NEW 1982
Free! 40 PAGE CATALOG Free!

<p>FLAT LEVER MINI-TOGGLE S.P.D.T. (ON-ON)</p> <p>C & H 7105 STANDARD FLAT LEVER RATED: 5AMP 125 VOLTS 1/4X40 BUSHING</p> <p>\$1.00 EACH 10 for \$ 8.50 100 for \$75.00</p>	<p>SPECIAL MRF 901</p> <p>MICROWAVE TRANSISTOR \$2.50 EA.</p> <p>COMPUTER GRADE CAPACITORS</p> <p>25,000 mfd. 75 VDC 3" DIA X 4 3/8" HI \$4.50</p> <p>45,000 mfd. 25 VDC 2" DIA X 4" HI \$3.50</p> <p>72,000 mfd. 15 VDC 2" DIA X 4" HI \$3.50</p>
---	---

ALL ELECTRONICS CORP.

905 S. Vermont Ave.
P.O. BOX 20406
Los Angeles, Calif. 90006
(213) 380-8000

Mon. - Fri. 9 AM - 5 PM Saturday 10 AM - 3 PM

TERMS

- Quantities Limited
- Min. Order \$10.00
- Add \$2.50 Shipping USA
- Call Res. Add 6%
- Prompt Shipping



FAST SCAN

*\$249

A modular approach... for your own custom-designed ATV system... Here's how

TXA5-4 ATV EXCITER/MODULATOR \$89 ppd

This wired and tested module is designed to drive the Motorola MHW-710 module in the PA5 10 watt linear amp. The crystal in the 100 MHz region keeps harmonics out of two meters for talk back. The video modulator is full 8 MHz for computer graphics and color. Requires 13.8 vdc reg @ 70 ma. Tuned with xtal on 439.25, 434.0, or 426.25 mhz. Provision for sync expanding Two frequencies available.



PA5 10 WATT ATV POWER MODULE \$89 ppd

The PA5 will put out 10 watts RMS power on the sync tips when driven with 80 mw by the TXA5 exciter. 50 ohms in and out, plus bandwidth for the whole band with good linearity for color and sound. Requires 13.8 vdc regulated @ 3 amps



FMA5 AUDIO SUBCARRIER GENERATOR \$29 ppd

Puts audio on with your camera video just as broadcast TV does at 4.5 MHz. Puts out up to 1 v p-p to drive the TXA5 or VM-2, 3, or 4 modulators. Requires low Z mic (150 to 600 ohms), and +12 to 18 vdc @ 25 ma. Works with any xmttr with 5 MHz video bandwidth.



TVC-2 ATV DOWNCONVERTER... \$55 ppd

Stripline MRF901 (1.7 db NF) preamp and double balanced mixer module digs out the weak ones but resists intermod and overload. Connects between uhf antenna and TV set tuned to channel 2 or 3. Varicap tunes 420 to 450 MHz. Requires +12 to 18 vdc @ 20 ma. Super sensitive TVC-2L with NE64535 preamp! 9db NF! stage... \$69 ppd



*TXA5, PA5, FMA5 and TVC Basic Module Pkg.

Call or write for our complete list of specifications, station set-up diagrams, and optional accessories which include antennas, modulators, detectors, test generators, cameras, etc. **WE ARE A FULL-LINE SUPPLIER OF ALL YOUR ATV NEEDS.**

**Credit Card Orders Call (213) 447-4565
SEE US AT DAYTON — BOOTH 71**

P.C. ELECTRONICS 2522 Paxson Lane,
Tom W6ORG Maryann WB6YSS Arcadia, California 91006

We hate to do it But we must

Effective July 1st, the yearly subscription rate for **ham radio Magazine** will increase to \$19.50. We've held the line as long as we could and even now we will be well below the \$25 charged by two of our competitors.

Yes it will cost more. But it means that we can continue to give you the magazine you want. Chock-full of all the latest state-of-the-art technical developments. From antennas to microwaves, it's all in **Amateur Radio's favorite independent, ham radio Magazine!**

You can renew or extend your subscription at the old rates up till June 30, 1982. Act now before you forget.

USE THIS COUPON OR HANDY CARD BETWEEN PAGES 2 AND 5

___ New ___ Renewal ___ Years @ 16.50 ea.

Name _____

Address _____

City _____ State _____ Zip _____

___ Bill me ___ Payment enclosed

___ Mastercard ___ VISA

Card Number _____ Expires _____

HAM RADIO MAGAZINE GREENVILLE, NH 03048

State of the art



by

K.V.G.

9 MHz CRYSTAL FILTERS

MODEL	Application	Bandwidth	Poles	Price
XF-9A	SSB	2.4 kHz	5	\$50.60
XF-9B	SSB	2.4 kHz	8	68.60
XF-9B-01	LSB	2.4 kHz	8	91.35
XF-9B-02	USB	2.4 kHz	8	91.35
XF-9B-10	SSB	2.4 kHz	10	119.65
XF-9C	AM	3.75 kHz	8	73.70
XF-9D	AM	5.0 kHz	8	73.70
XF-9E	FM	12.0 kHz	8	73.70
XF-9M	CW	500 Hz	4	51.55
XF-9NB	CW	500 Hz	8	91.35
XF-9P	CW	250 Hz	8	124.95
XF910	IF noise	15 kHz	2	16.35

10.7 MHz CRYSTAL FILTERS

XF107-A	NBFM	12 kHz	8	\$64.10
XF107-B	NBFM	15 kHz	8	64.10
XF107-C	WBFM	30 kHz	8	64.10
XF107-D	WBFM	36 kHz	8	64.10
XF107-E	Pix/Data	40 kHz	8	64.10
XM107-SO4	FM	14 kHz	4	28.70

Write for Data Sheets.
Export Inquiries Invited.

Shipping \$3.50

MICROWAVE MODULES VHF & UHF EQUIPMENTS

Use your existing HF or 2M rig on other VHF or UHF bands.

TRANSVERTERS

Models: 10M IF to 6M thru 435 MHz RF	from \$219.95
2M IF to 1269/1296 MHz RF	from \$399.95
Ch2/3 IF to 421/439 MHz ATV RF	from \$349.95

Low Noise RECEIVE CONVERTERS

6M thru 1296 MHz RF, 10M thru 2M IF	from \$64.95
421/439 MHz RF, Ch2/3 ATV IF	from \$74.95
1275 MHz RF, Ch7/8 ATV IF	from \$169.95
also 1691 MHz RF, 137.5 MHz IF	from \$269.95

POWER AMPLIFIERS

2 Meters 25 thru 100 watts	from \$134.95
432 MHz 20 thru 100 watts	from \$174.95
1296 MHz 10 watts	from \$469.95

Write for technical data and price details.

ANTENNAS

(FOB CONCORD, VIA UPS)

144-148 MHz J-SLOTS		
8 over 8 Hor. pol D8/2M	12.3 dBd	\$68.40
8 by 8 Vert. pol D8/2M-vert	12.3 dBd	82.90
8 + 8 Twist 8XY/2M	9.5 dBd	71.40

420-450 MHz MULTIBEAMS

48 Element 70/MBM48	15.7 dBd	75.75
88 Element 70/MBM88	18.5 dBd	105.50

UHF LOOP YAGIS

1250-1350 MHz 28 loops 1296-LY 20 dBi	49.75
1650-1750 MHz 28 loops 1691-LY 20 dBi	55.95
Order Loop-Yagi connector extra: Type N	14.95
SMA	6.45

Send 40¢ (2 stamps) for full details of all your VHF & UHF equipment and KVG crystal product requirements.



Local Agents:

Florida: Silvernail Electronics, Inc., Largo, FL
Mid-West: Lee-Tronics, Ltd., Canton, IL
California: P.C. Electronics, Arcadia, CA
N.W. & Alaska: Spectrum West, Seattle, WA

(813) 595-3317
(309) 647-0153
(213) 447-4565
(206) 523-6167

si

(617) 263-2145
**SPECTRUM
INTERNATIONAL, INC.**
Post Office Box 1084
Concord, MA 01742, U.S.A.



Ham Radio's guide to help you find your local

California

C & A ELECTRONIC ENTERPRISES
22010 WILMINGTON AVE.
SUITE 105
CARSON, CA 90745
213-834-5868
Not The Biggest, But The Best —
Since 1962.

JUN'S ELECTRONICS
3919 SEPULVEDA BLVD.
CULVER CITY, CA 90230
213-390-8003 Trades
714-463-1886 San Diego
The Home of the One Year Warranty
— Parts at Cost — Full Service.

SHAVER RADIO, INC.
1378 S. BASCOM AVENUE
SAN JOSE, CA 95128
408-998-1103
Azden, Icom, Kenwood, Tempo,
Ten-Tec, Yaesu and many more.

Connecticut

HATRY ELECTRONICS
500 LEDYARD ST. (SOUTH)
HARTFORD, CT 06114
203-527-1881
Call today. Friendly one-stop shop-
ping at prices you can afford.

Delaware

DELAWARE AMATEUR SUPPLY
71 MEADOW ROAD
NEW CASTLE, DE 19720
302-328-7728
Icom, Ten-Tec, Swan, DenTron,
Tempo, Yaesu, Azden, and more.
One mile off I-95, no sales tax.

Florida

AMATEUR ELECTRONIC SUPPLY
1898 DREW STREET
CLEARWATER, FL 33515
813-461-HAMS
Clearwater Branch
West Coast's only full service
Amateur Radio Store.

AMATEUR ELECTRONIC SUPPLY
621 COMMONWEALTH AVE.
ORLANDO, FL 32803
305-894-3238
Fla. Wats: 1 (800) 432-9424
Outside Fla: 1 (800) 327-1917

AMATEUR RADIO CENTER, INC.
2805 N.E. 2ND AVENUE
MIAMI, FL 33137
305-573-8383
The place for great dependable
names in Ham Radio.

RAY'S AMATEUR RADIO
1590 US HIGHWAY 19 SO.
CLEARWATER, FL 33516
813-535-1416
Your complete Amateur Radio and
Computer Store.

Indiana

THE HAM SHACK
808 NORTH MAIN STREET
EVANSVILLE, IN 47710
812-422-0231
Discount prices on Ten-Tec, Cubic,
Hy-Gain, MFJ, Azden, Kantronics,
Santec and others.

Kansas

ASSOCIATED RADIO
8012 CONSER, P. O. BOX 4327
OVERLAND PARK, KS 66204
913-381-5900
America's No. 1 Real Amateur Radio
Store. Trade — Sell — Buy.

Maryland

THE COMM CENTER, INC.
LAUREL PLAZA, RT. 198
LAUREL, MD 20810
800-638-4486
Kenwood, Drake, Icom, Ten-Tec,
Tempo, DenTron, Swan & Apple
Computers.

Massachusetts

TEL-COM, INC.
675 GREAT ROAD, RTE. 119
LITTLETON, MA 01460
617-486-3040
617-486-3400 (this is new)
The Ham Store of New England
You Can Rely On.

Minnesota

MIDWEST AMATEUR RADIO SUPPLY
3452 FREMONT AVE. NO.
MINNEAPOLIS, MN 55412
612-521-4662
It's service after the sale that counts.

Nevada

AMATEUR ELECTRONIC SUPPLY
1072 N. RANCHO DRIVE
LAS VEGAS, NV 89106
702-647-3114
Pete, WA8PZA & Squeak, AD7K
Outside Nev: 1 (800) 634-6227

New Hampshire

TUFTS ELECTRONICS
61 LOWELL ROAD
HUDSON, NH 03051
603-883-5005
New England's friendliest ham store.

New Jersey

RADIOS UNLIMITED
P. O. BOX 347
1760 EASTON AVENUE
SOMERSET, NJ 08873
201-469-4599
New Jersey's only factory authorized
Yaesu and Icom distributor. New and
used equipment. Full service shop.

ROUTE ELECTRONICS 48
225 ROUTE 46 WEST
TOTOWA, NJ 07512
201-256-8555

Dealers: *YOU SHOULD BE HERE TOO!*
Contact Ham Radio now for complete details.

Amateur Radio Dealer

ROUTE ELECTRONICS 17

777 ROUTE 17 SOUTH
PARAMUS, NJ 07625
201-444-8717
Drake, Cubic, DenTron, Hy-Gain,
Cushcraft, Hustler, Larsen, MFJ,
Butternut, Fluke & Beckman
Instruments, etc.

New York

BARRY ELECTRONICS

512 BROADWAY
NEW YORK, NY 10012
212-925-7000
New York City's Largest Full Service
Ham and Commercial Radio Store.

GRAND CENTRAL RADIO

124 EAST 44 STREET
NEW YORK, NY 10017
212-599-2630
Drake, Kenwood, Yaesu, Atlas,
Ten-Tec, Midland, DenTron, Hy-Gain,
Mosley in stock.

HARRISON RADIO CORP.

20 SMITH STREET
FARMINGDALE, NY 11735
516-293-7990
"Ham Headquarters USA" since
1925. Call toll free 800-645-9187.

RADIO WORLD

ONEIDA COUNTY AIRPORT
TERMINAL BLDG.
ORISKANY, NY 13424
TOLL FREE 1 (800) 448-9338
NY Res. 1 (315) 337-0203
Authorized Dealer — ALL major
Amateur Brands.
We service *everything* we sell!
Warren K2IXN or Bob WA2MSH.

Ohio

AMATEUR ELECTRONIC SUPPLY

28940 EUCLID AVE.
WICKLIFFE, OH (CLEVELAND AREA)
44092
216-585-7388
Ohio Wats: 1 (800) 362-0290
Outside Ohio: 1 (800) 321-3594

UNIVERSAL AMATEUR RADIO, INC.

1280 AIDA DRIVE
REYNOLDSBURG (COLUMBUS), OH
43068
614-866-4267
Featuring Kenwood and all other
Ham gear. Authorized sales and ser-
vice. Shortwave headquarters. Near
I-270 and airport.

Oklahoma

DERRICK ELECTRONICS, INC.
714 W. KENOSHA — P.O. BOX A
BROKEN ARROW, OK 74012
Your *Discount* Ham equipment dealer
in Broken Arrow, Oklahoma
1-800-331-3688 or
1-918-251-9923

Pennsylvania

**HAMTRONICS,
DIV. OF TREVOSE ELECTRONICS**
4033 BROWNSVILLE ROAD
TREVOSE, PA 19047
215-357-1400
Same Location for 30 Years.

LaRUE ELECTRONICS

1112 GRANDVIEW STREET
SCRANTON, PENNSYLVANIA 18509
717-343-2124
Icom, Bird, Cushcraft, Beckman,
Fluke, Larsen, Hustler, Astron,
Antenna Specialists, W2AU/W2VS,
AEA, B&W, CDE, Sony, Vibroplex.

Virginia

ELECTRONIC EQUIPMENT BANK
516 MILL STREET, N.E.
VIENNA, VA 22180
703-938-3350
Metropolitan D.C.'s One Stop
Amateur Store. Largest Warehousing
of Surplus Electronics.

Wisconsin

AMATEUR ELECTRONIC SUPPLY
4828 W. FOND DU LAC AVE.
MILWAUKEE, WI 53216
414-442-4200
Wisc. Wats: 1 (800) 242-5195
Outside Wisc: 1 (800) 558-0411

**SAY
YOU SAW
IT IN
ham radio!**

KENWOOD

\$SAVES\$

\$CALL TOLL FREE\$



TS530S



**SEE KENWOOD
CENTERSPREAD
USE BONUS BUCK
COUPON AND SAVE!!!**



TR7730



**THE
COMM
CENTER
INC.**
Laurel Plaza
Route 198
Laurel, Md.
20810
MD.: 301-792-0600
OPEN TUES. THROUGH SAT.

**CALL TOLL FREE
1-800-638-4486**

A useful instrument
that does a good job
on ham-band inductances

easy-to-build inductance meter

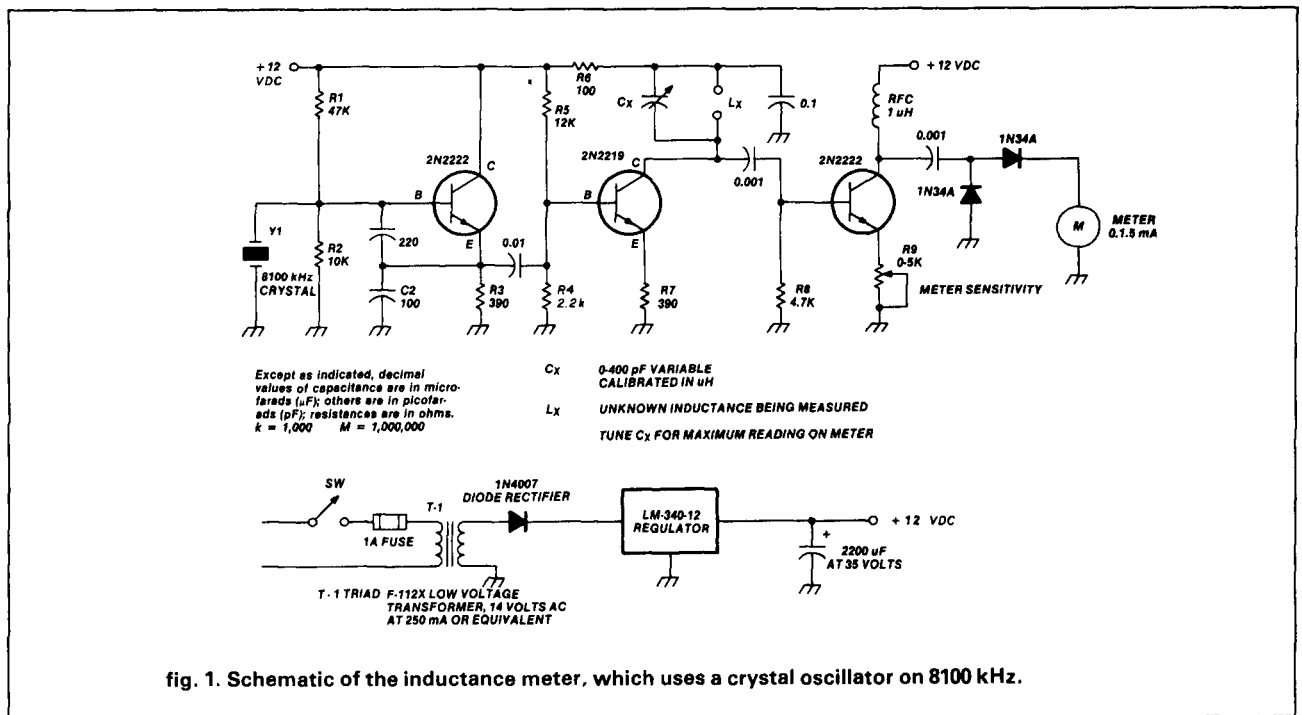

This handy instrument will permit you to measure inductance from $0.5 \mu\text{H}$ to about $10 \mu\text{H}$ by reading a capacitor dial. I came up with this idea for my own work bench after searching for a good circuit for measuring inductance. This device does the job for the ham bands, and I hope you will like it as much as I do.

description

This inductance meter uses a crystal oscillator on a frequency of 8100 kHz (see fig. 1). The oscillator drives an amplifier. The unknown inductance is placed in the collector lead, and a capacitor across it is tuned for resonance. The dial is calibrated in μH so

that the inductance can be read directly.

Another amplifier is used to build up the r-f voltage to operate the 0 to 1.5 mA meter used for tuning to a peak for resonance. A more sensitive meter (such as a $0-50 \mu\text{A}$) could be used by shunting a 120-ohm resistor across it, if that is what you happen to have in the junk box.

I suppose the first question that will be asked is, "Why use 8100 kHz for the crystal oscillator?" Well, a surplus 8100-kHz crystal is cheaper to buy than one

By Ed Marriner, W6XM, 528 Colima Street, La Jolla, California 92037

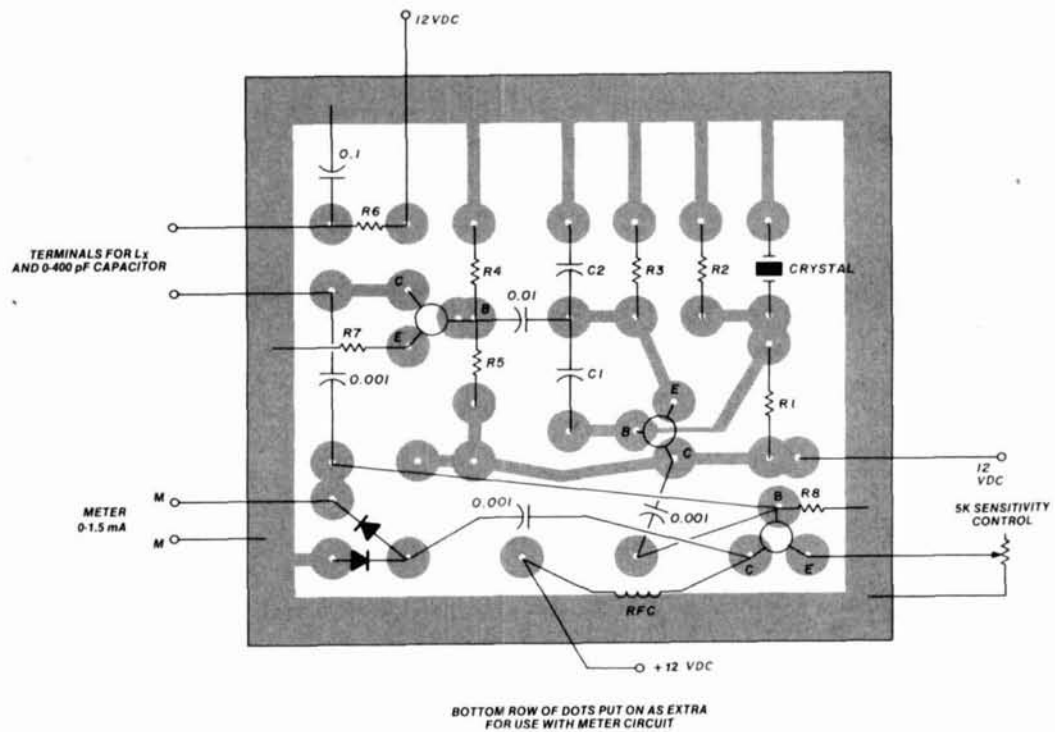
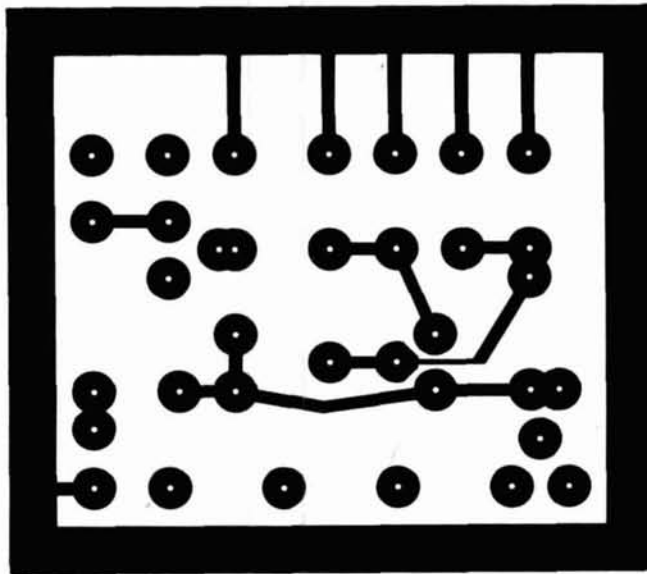

fig. 2. Printed-circuit board and parts placement for the inductance meter.

table 1. Capacitor calibration setting in μH .

pF	3500 kHz	7000 kHz	8100 kHz
	μH	μH	μH
10	200	51.6	38.5
20	165	25.7	19.2
30	70	17.2	12.8
40	52	12.9	9.6
50	42	10.3	7.7
60	34	8.5	6.4
70	30	7.3	5.5
80	26	6.4	4.8
90	23	5.7	4.2
100	21	5.17	3.8
125	17	4.5	3.0
150	14	3.4	2.5
175	12	2.9	2.2
200	16.5	2.5	1.92
225	8.6	2.3	1.6
250	8.4	2.0	1.5
300	7.6	1.7	1.2
325	6.0	1.5	1.1
350	6.5	1.4	1.1
375	5.7	1.3	1.0
400	5.5	1.2	0.9

Note: The 8100-kHz crystal was used because of its range and availability. Calibrate variable capacitor for whichever crystal you have from this formula:

$$\begin{aligned} f &= \text{Hertz} \\ L &= \text{Henrys} \\ C &= \text{Farads} \\ 4\pi^2 &= 39.5 \end{aligned}$$

$$L = \frac{1}{4\pi^2 \times f^2 \times C} = \frac{1}{39.5 \times f^2 \times C} = \frac{1}{(39.5)(7 \times 10^6)^2 (10 \times 10^{-12})}$$

$$\text{Example: } 7000 \text{ kHz} = \frac{1}{39.5 \times 49 \times 10} = 0.0000516, \text{ or } 51.6 \mu\text{H}$$

for the ham bands. Also, if you examine the chart in table 1, you will see that the choice of a 10-400 pF capacitor covers a good range of inductances to be measured. Of course, it's your choice which span you want to cover. If another crystal frequency is used, calibrate the variable capacitor by using the formula in table 1. I was surprised to learn that this formula is not shown in most handbooks.

The accuracy of the dial reading in μH will only be as good as the accuracy with which you can measure the variable capacitor. A better way would be to check or calibrate the dial against known inductance values. Some suggestions on where to obtain inductances of known value are shown under the sub-heading calibration. (I found that Air-Dux coils did not correspond to the values shown in their listing, and I wouldn't use them for calibrating the meter unless they were measured first.)

construction

There is nothing difficult about building this tester once you've located the parts. Some sources for parts are listed at the end of the article. The printed-circuit layout I used is shown in fig. 2. I cut the board by gripping it between two pieces of angle iron and using a hack saw. Then I filed the edges, sanded the copper with steel wool, and used paper drafting tape for the masking. The dots were Avery self-adhesive color-coding labels that I bought at a stationery store. The wider tape I used for the border is Bishop precision-type 201-250-11, 1/4 inch \times 20 yards (6.35 mm \times 18.2 m). It's expensive, and yellow shelf-paper with stickum on the back can be used, if you prefer, by cutting it on a paper cutter.

The board was etched with ferric chloride, which takes about an hour, but the process can be speeded up by placing a lamp over the solution and juggling it around once in a while. Once the board has been etched and cleaned, by again scrubbing it with steel wool, it should be tinned with a hot soldering iron. Be careful not to apply too much heat, or the copper will come off! (There are other ways of tinning, using a solution.)

The holes can be drilled out using a No. 60 (1-mm) drill. The crystal socket was mounted using a spacer and a long 4-40 (M3) machine screw.

Before putting a unit in a box, test it out by determining if the crystal oscillator is working. Using FT-243 crystals, I found my values of C-1 and C-2 to be correct as shown. Handbooks call for other values, but they did not make the oscillator work for me. You can listen for the oscillator at 8100 kHz with a receiver or put an rf probe at the emitter output. You should have 1.5 volts of rf, enough to drive the following amplifier. The amplifier can also be checked by placing a coil in the collector, resonating it, and measuring with the probe at the collector. A coil with a value of 3-10 μH should be sufficient for this test.

I used germanium diode rectifiers to operate the meter because they provide more dc voltage than the silicon type. The 1N34A, 1N38, or 1N64 work well.

I used a Radio Shack cabinet, 5-1/4 \times 3 \times 5-5/8 inches (13.3 \times 7.6 \times 14.3 cm), to house all the parts including the power supply. Before installing the parts mount the capacitor on a piece of plastic to insulate it from the cabinet; use an insulated coupler and plastic shaft through a panel bushing for the dial knob. I used GR terminals with long shanks that went right up to the capacitor terminals. Make the leads as short as possible, because they become part of the inductance.

Once the amplifier has been finished it can be checked by advancing the sensitivity control and resonating a coil placed on the terminals. I put a 100-

table 2. Some values of Air-Dux coils which might be used to calibrate or check the dial. Values must be checked first.

Air Dux number	total inductance of coil (μH)
404	0.18
406	0.39
408	0.71
410	1.10
416	2.87
432	11.30
504	0.27
506	0.61
508	1.10
510	1.60
516	4.30
532	17.30
604	0.38
606	0.86
608	1.52
610	2.38
616	6.08
632	24.20
804	1.02
806	2.33
810	6.47
816	16.30
832	66.30

Other values of coils can be obtained by writing Illumitronic Engineering Corporation, 680 East Taylor Avenue, Sunnyvale, California.

ohm resistor in series with the control to limit the current reading and not ground the emitter. Most meters have the positive terminal on the left looking at the back. If your meter does not read, or reverse readings are obtained, turn the meter leads around. The meter dial plate is shown in fig. 3.

calibration

Several suggestions on calibrating the dial are given. I used a 0-400 pF capacitor, a BDC type out of Swan equipment, that I found at a flea market. The 0-365 pF units are more common and are available from J.W. Miller and Radio Shack.

One of the best ways of calibrating or checking your dial readings is to use the rf chokes listed below. They seem to be very accurate:

Miller rfc 420	0.22 μH
Miller rfc 220	0.82 μH
Miller rfc 144	1.72 μH
Miller rfc 50	8.20 μH
Ohmite Z-50	10.00 μH

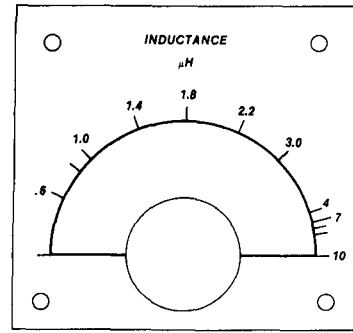

fig. 3. Inductance meter dial plate.

Other values of the type 4500 and 70F106AI chokes can be obtained from the J.W. Miller catalog (J.W. Miller, 19070 Royes Avenue, Compton, California 70224). If you know someone who can measure inductance, the Air-Dux line in the 400, 500, 600 and 800 series are also good to use. Some of the approximate values of Air-Dux are given in table 2.

table 3. Reference chart for other J.W. Miller coils that could be used for calibration.

J.W. Miller stock No.	inductance μH	Q
4580	0.10	70
4582	0.15	80
4584	0.22	95
4586	0.33	100
4588	0.47	105
4590	0.68	113
4592	0.75	115
4594	0.82	112
4602	1.00	58
4604	1.50	62
4606	2.40	63
4608	3.90	70
4609	5.50	70
4610	6.20	67
4611	8.20	67
4612	10.0	67
4622	10.0	70
4624	15.0	58
4628	39.0	93
70F106AI	2.0	
70F226AI	2.2	
70F336AI	3.3	
70F396AI	3.9	
70F476AI	4.7	
70F686AI	6.8	
70F826AI	8.2	
70F105AI	10.0	

See the catalog for a complete list of values in between. Contact J.W. Miller Co., Sales, Mr. Bill Courtney, 19070 Royes Avenue, Compton, California 90224.

**SPRING MEANS
ANTENNAS**

KLM KT-34 SERIES BROADBAND AND EFFICIENT

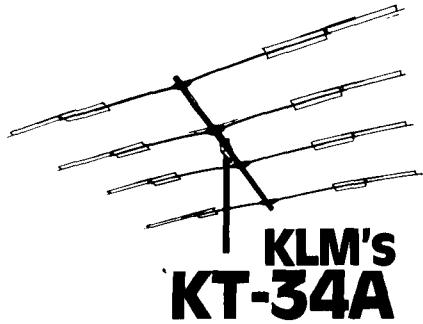

The
Original

**KLM'S
KT-34A**

- 14.0-14.350, 21.0-21.45, 28.0-29.750 MHz
- 4KW PEP • 50Ω feed with balun
- F/S 30dB • F/B 20 dB
- 24 ft. longest element

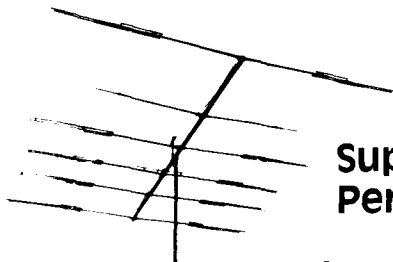

**Super
Performance**

And the "X-rated"
KT34XA

SAME BASIC SPECS AS THE KT-34 BUT:

- 32 foot boom
- 2-4 dB more gain depending on band
- Overhead boom support with "Phillystran" non-conductive, non-reactive guy wire

SEE YOU AT DAYTON. WE'LL BE SHOWING OUR
FULL LINE OF ANTENNAS, AMPS & TVRO

KLM

P.O. Box 816, Morgan Hill, CA 95037
(408) 779-7363

Table 3 gives values for some J.W. Miller coils, and table 4 shows some typical toroid values. All these components are available from many sources throughout the country.

table 4. Some typical toroid values collected from magazine articles.

band	core	inductance (μ H)	no. turns	enamel wire size AWG (mm)
40 meters	T-50-2	13	50	28 (0.3)
20 meters	T-50-2	8	44	28 (0.3)
15 meters	T-50-2	4	25	28 (0.3)
10 meters	T-50-2	0.6	12	24 (0.5)

Note the red core is type 2, and the yellow core type 6.

core	inductance (μ H)	no. turns	enamel wire size AWG (mm)
T-68-1	0.5	10	22 (0.6)
T-68-6	0.5	8	20 (0.8)
T-68-6	0.7	12	22 (0.6)
T-68-6	0.8	13	26 (0.4)
T-68-6	1.0	14	20 (0.8)
T-68-2	1.2	13	20 (0.8)
T-68-2	1.8	19	22 (0.6)
T-68-2	2.0	20	22 (0.6)
T-68-2	2.1	22	22 (0.6)
T-68-2	6.0	32	24 (0.5)
T-68-2	7.0	32	24 (0.5)
T-68-2	21.0	56	24 (0.5)
T-68-2	24.0	60	28 (0.3)
T-50-2	0.57	7	26 (0.4)
T-50-6	0.60	12	24 (0.5)
T-50-2	1.70	17	26 (0.4)
T-50-2	0.9	11	20 (0.8)
T-50-6	2.4	25	26 (0.4)
T-32-2	0.28	8	22 (0.6)
T-32-2	0.37	9	22 (0.6)
T-32-2	0.8	14	22 (0.6)
T-32-2	1.0	22	22 (0.6)
T-32-2	2.6	25	26 (0.4)
T-32-2	3.0	27	26 (0.4)
T-32-2	6.0	37	28 (0.3)

Note: T-94 coil is 0.94 inch dia. (24 mm)
T-80 core is 0.79 inch dia. (20 mm)
T-68 core is 0.69 inch dia. (17.5 mm)
T-50 core is 0.50 inch dia. (12.7 mm)

Perhaps this little gadget is not the best way to measure inductance, but I find it does the job for most of my construction projects, especially for ham-band inductances.

Another reference for a final check of your dial: ARRL L/C/F Calculator Type A.

ham radio

flea market



RATES Noncommercial ads 10¢ per word; commercial ads 60¢ per word both payable in advance. No cash discounts or agency commissions allowed.

HAMFESTS Sponsored by non-profit organizations receive one free Flea Market ad (subject to our editing) on a space available basis only. Repeat insertions of hamfest ads pay the non-commercial rate.

COPY No special layout or arrangements available. Material should be typewritten or clearly printed (not all capitals) and must include full name and address. We reserve the right to reject unsuitable copy. **Ham Radio** cannot check each advertiser and thus cannot be held responsible for claims made. Liability for correctness of material limited to corrected ad in next available issue.

DEADLINE 15th of second preceding month.

SEND MATERIAL TO: Flea Market, Ham Radio, Greenville, N. H. 03048.

QSL CARDS

QSL's — BE PLEASANTLY SURPRISED! Order our three colored QSL's in all varieties for \$8.00 per 100 or \$13.00 for 200. Satisfaction guaranteed. Samples \$1.00 (refundable). Constantine Press, 1219 Ellington, Myrtle Beach, SC 29577.

QSLs & RUBBER STAMPS — Top Quality! Card Samples and Stamp Info — 50¢ — Ebbert Graphics 5R, Box 70, Westerville, Ohio 43081.

QSL CARDS: 500/\$12.50, ppd. Free catalogue. Bowman Printing, 743 Harvard, St. Louis, MO 63130.

QSL'S: No stock designs! Your art or ours; photos, originals, 50¢ for samples & details (refundable). Certified Communications, 4138 So. Ferris, Fremont, Michigan 49412.

DISTINCTIVE QSL's — Largest selection, lowest prices, top quality photo and completely customized cards. Make your QSL's truly unique at the same cost as a standard card, and get a better return rate! Free samples, catalogue. Stamps appreciated. Stu K2RPZ Print, P.O. Box 412, Rocky Point, NY 11778 (516) 744-6260.

Foreign Subscription Agents for Ham Radio Magazine

Ham Radio Austria
F. Basti
Hauptplatz 5
A-2700 Wiener Neustadt
Austria

Ham Radio Belgium
Stereochine
Brusselsesteenweg 416
B-9218 Gent
Belgium

Ham Radio Canada
Box 400, Goderich
Ontario, Canada N7A 4C7

Ham Radio Europe
Box 444
S-194 04 Upplands Vasby
Sweden

Ham Radio France
SM Electronic
20 bis, Ave des Clairons
F-89000 Auxerre
France

Ham Radio Holland
Postbus 413
NL-7800 Ar Emmen
Holland

Ham Radio Italy
G. Vulperti
P.O. Box 37
I-22063 Cantu
Italy

Ham Radio Switzerland
Karrn Ueber
Postfach 2454
D-7850 Loerach
West Germany

Ham Radio UK
P.O. Box 63, Harrow
Middlesex HA3 6HS
England

Holland Radio
143 Greenway
Greenside, Johannesburg
Republic of South Africa

CADILLAC OF QSL CARDS, 3 to 4 colors, send \$1 for samples (Refundable). Mac's Shack, P.O. Box 43175, Seven Points, TX 75143.

MOBILE OPERATORS: Anteck's Mobile Antennas cover 3.2 to 30 MHz inclusive, with no coil changing. 50 Ohms input. Two models, the MT-1 MANUAL, MT-1RT REMOTE-TUNED from the operators position. Uses two Hyd. Pumps and Motors. MT-1 \$129.95, MT-1RT \$240.00 plus UPS postage. Check your local dealer or write for Dealer List and Brochure. ANTECK, INC., Route One, Box 415, Hansen, ID 83334. 208-423-4100.

WANTED: Micor and Mstr II Base Stations 406-420 and 450-470 MHz. Also 2 and 6 GHz solid state microwave equipment. AK7B, 4 Ajax Place, Berkeley, CA 94708.

AMP-LETTER: Devoted to designing, building, and operating Amateur Radio Amplifiers. Sample \$2.00. AMP-LETTER, RR2 Box 39A, Thompsonville, IL 62890.

TUBES, TUBES wanted for cash or trade. 304TL, 4CX1000A, 4PR60C, 7F7, 7N7, 53, 6L6M. Any high power or special purpose tubes of Eimac/Varian. DCO, 10 Schuyler Avenue, No. Arlington, NJ 07032. (800) 526-1270.

HAM RADIO FANATICS! You need the W5YI Report — Twice monthly award-winning insider newsletter. 24 issues — \$18.00. Sample issue SASE (2 stamps), W5YI, Box #10101-H, Dallas, Texas 75207.

KENWOOD TS-820S, two years old. Excellent condition. Call after 6:00 PM. (203) 348-3983.

ATLAS DD6-C Digital Dial \$120.00 plus \$4.00 UPS. NEW, while they last. Mical Devices, P.O. Box 343, Vista, CA 92083.

COLLINS KWS-1. Excellent condition with manual. Bruce Ascough, W5VJX, 800 Eight Ave., Suite 240, Fort Worth, Texas 76104. (817) 338-1466.

CONNECTICUT'S Ham Store — Rogus Electronics, 250 Meriden-Waterbury Turnpike, (Rt. 66) Southington. (203) 621-2252.

IMPROVE MORSE INTERPRETATION — automatically. Fully integrated microelectronics hardware, software. Unusual features. \$169. Telecraft Laboratories, Box 1185, E. Dennis, Mass. 02641.

RTTY JOURNAL-EXCLUSIVELY AMATEUR RADIOTELETYPE, one year subscription \$7.00. Beginners RTTY Handbook \$5.00, RTTY Index \$1.50. P.O. Box RY, Cardiff, CA 92007.

CW FILTER, 250 Hz, for all Yaesu FT-101A through FT-101E. Excellent condition \$10. Also SSB filter, \$10.00. John Skubick, K8JS, 791 - 106 Avenue, Naples, FL 33940.

CUSTOM EMBROIDERED EMBLEMS — Your design, low minimum. Informational booklet. Emblems, Dept 65, Littleton, New Hampshire 03561. (603) 444-3423.

OUR KEYERS turn difficult DX into logged contacts. SASE for information. Webco, Box 740211, Houston, Texas 77274.

WANTED: Pre-1950 TV sets and old TV Guides. Jeff Kadet, W3CRH, Box 90-HR, Rockville, MD 20850. (301) 654-1876.

RTTY FOR SALE: Several machines remaining. Model 15, Model 19, 28RO w/gearshift, p.s. for ROBOT 800, deluxe 34ASR, 28KSR, 28 keyboard typing reper, 28TD's, 33KSR, 33ASR, 35KSR, several demodulators, video RTTY. Model 28 gearshifts, parts and supplies. Send SASE for complete list and prices. Lawrence R. Pfleger, K9WJB, 2600 S. 14th Street, St. Cloud, MN 56301. Phone (612) 255-9794.

MANUALS for most ham gear made 1937/1970. Send \$1.00 for 18 page "Manual List", postpaid. HI-MANUALS, Box H802, Council Bluffs, Iowa 51502.

DON'T GET STRANDED! Battery Watchdog's alarm informs you of excess power drain. \$19.95. J.F. Ratcliff, 3600 Meadow N., Renton, WA 98056. SASE brochure.

SB-102, SB-600, PS, CW filter. MINT honest. Original owner. K5PA, 12412 Mossybank, Austin, TX 78750. (512) 258-4959. \$390.

WANTED: April '68 issue of HAM RADIO will buy or trade other issues. J. Smith, 700 S.W. 16th Place, Gainesville, FL 32601.

ELECTRONIC BARGAINS, CLOSEOUTS, SURPLUS! Parts, equipment, stereo, industrial, educational. Amazing values! Fascinating items unavailable in stores or catalogs anywhere. Unusual FREE catalog. ETCO-012, Box 762, Plattsburgh, NY 12901. SURPLUS WANTED.

OSCILLOSCOPE — Heath Model IO-4510, dual-trace, DC-10 MHz, delay line, sweep expansion, X-Y display, calibrator, like new, \$300.00. W2BLL, RD 2, Box 72, Boonton, NJ 07005.



The HAM SHACK

808 N. Main • Evansville, IN 47711

TEN-TEC	
546 Omni-C Xcvr	\$1050
580 Delta	740
525 Argosy	480
229 2KW Antenna Tuner	225
227 200W Antenna Tuner	72
234 Speech Processor	120
243 Remote VFO-Omni	169
217, 218, 219 or 220 IF Filters	49
215P Microphone	25

SANTEC	
ST 144/μP 2m Hand-Held	299

AEA MBA Reader	270
AZDEN PCS-300 2m Hand Held	call
BUTTERNUT HF6V Vertical	109
CUBIC Astro 103	1175
HAL CT2100	695
HY-GAIN TH7 DX	call
HY-GAIN HAM IV Rotator	169
KLM KT34A	315
ICOM 25A	309
ICOM 730	700
MFJ 496 Keyboard	290
MIRAGE B108	155
VoCom Pocket Power	195

812-422-0231
MON-FRI 9AM-6PM • SAT 9AM-3PM

Write for our new and used equipment list

CABLE TV UHF UP CONVERTER \$44.95 . . . (Reg. \$59.95) (shipping \$3.25)



MICROVERTER VUC-36

Converts Mid and Superband Signals to UHF Channels 43 to 83. Allows all sets to tune without costly separate selector boxes. *Rated #1. Accessory kit available for \$2.00, consisting of matching transformer plus 2 jumper cables.

Call or write for Free Catalog

Other 75 ohm Cable Supplies:

2-way Cable Switch	\$4.95
F59A Connectors	10/\$2.15
MT6UVFM Back of Set XFMR	\$2.39
2-way Splitter	\$2.79
4-way Splitter	\$4.39
F81 "F" Barrel	\$.48
RG-59/U Coax 100% Foil	\$.10/ft
Inline Grounding Block	\$1.89
Outdoor Matching XFMR	\$2.25
Indoor Matching XFMR	\$1.25
F61 Chassis Mt. Female	\$.48

Parts shipping add 10%, \$1.50 minimum. COD add \$1.50. Fla. Res. add 4%.

NEMAL ELECTRONICS

5685 SW 80th Street, Miami, FL 33143
Telephone: (305) 661-5534

When it comes to AMATEUR RADIO QSL's...

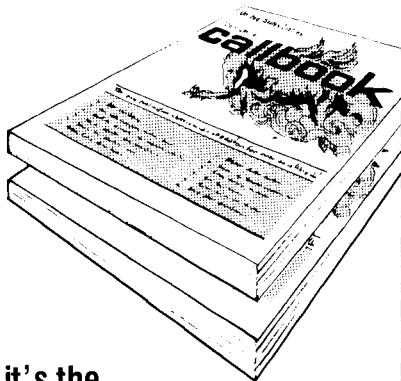

it's the
ONLY BOOK!

US or Foreign Listings

1982 callbooks

Here they are! The latest editions, World-famous Radio Amateur Callbooks, the most respected and complete listing of radio amateurs. Lists calls, license classes, address information. Loaded with special features such as call changes, prefixes of the world, standard time charts, worldwide QSL bureaus, and more. The U.S. Edition features over 400,000 listings, with over 70,000 changes from last year. The Foreign Edition has over 370,000 listings, over 60,000 changes. Place your order for the new 1982 Radio Amateur Callbooks, available now.

	Each	Shipping	Total
US Callbook	\$18.95	\$3.05	\$22.00
Foreign Callbook	\$17.95	\$3.05	\$21.00

Order both books at the same time for \$39.95 including shipping.

Order from your dealer or directly from the publisher. All direct orders add shipping charge. Foreign residents add \$4.55 for shipping. Illinois residents add 5% sales tax.



SPECIAL LIMITED OFFER!
**Amateur Radio
Emblem Patch**
only \$2.50 postpaid

Pegasus on blue field, red lettering. 3" wide x 3" high. Great on Jackets and caps.

ORDER TODAY!

RADIO AMATEUR
callbook INC.
Dept. F
925 Sherwood Drive
Lake Bluff, IL 60044, USA

HAM RADIO REPAIR, experienced, reasonable, commercial licensed. Robert Hall Electronics, P.O. Box 8363, San Francisco, CA 94128. W6BSH, (408) 292-6000.

OLD TIMERS — I need Vibroplex, McElroy, Logan and Johnson speed keys for my collection. Also need junkers for spare parts. K5RW, B.N. McEwen, 1128 Midway, Richardson, Texas 75081.

RUBBER STAMPS: 3 lines \$3.25 PPD. Send check or MO to G.L. Pierce, 5521 Birkdale Way, San Diego, CA 92117. SASE brings information.

BNC MALE CONNECTORS, silver plated, military surplus. Specify RG-58, RG-59, or 8X. 6/\$5, postage paid. Colonel Russell, 9410 Walhampton, Louisville, KY 40222.

MOBILE IGNITION SHIELDING provides more range with no noise. Available most engines. Many other suppression accessories. Literature, Estes Engineering, 930 Marine Dr., Port Angeles, WA 98362.

I WOULD LIKE TO GET a copy of the manual, circuit diagram, crystal information for the Standard SR-C146, 2 meter handheld transceiver. I am willing to pay any reasonable compensation. Any information on where this documentation can be obtained, i.e. club, library, etc., will be appreciated. Dennis Sladen, VE1BZJ.

QSL ECONOMY: 1000 for \$13. SASE for samples. W4TG, Box F, Gray, GA 31032.

TEKTRONIX 661 SCOPE: 4S1 d.t. sampling, 5T1 time base plug-ins; dc - 1 GHz \$250. C-12 scope camera \$175. aL60 spectrum analyzer p-i with manual "as is". \$125. A.P. Towbin, 436 Orange St., New Haven, CT 06511.

SEND 9 1/2" SASE for surplus parts and equipment catalog. Bill Williams, P.O. #7057, Norfolk, VA 23509.

MEISSNER SIGNAL SHIFTER, manual, coils, best offer or trade for good receiver. KA4TCV, 105 E. King Arthur Drive, Port Richey, FL 33568.

OVERPRINTED — 1981 Fox-Tango Club Newsletters. Sixty loose-leaf pages packed with modifications and information on Yaesu rigs. Only \$6 while they last. Also a few 1980 sets at \$5. (Overseas add \$3 each, airmail.) N4ML, Box 15944, W. Palm Beach, FL 33406.

SALE — HW-16 \$125 (w/crystals \$150). 2 Johnson match-box tuners, best \$50, other (needs repair) \$25. Heath 2 meter mobile amp \$30. 10-40 vertical \$25. You pay shipping. KA4EBW, Jim Howell, 18 Dan Street, Salisbury, NC 28144.

SATELLITE TELEVISION: Information on building or buying your earth station. Six pages of what's needed, where to get it, etc. \$4.00 to Satellite Television, RD #3, Oxford, NY 13830. Parabolic antenna construction book also available. Send SASE for details.

WANTED: New or used MS and coaxial connectors, synchros, tubes, components, military surplus equipment. Bill Williams, PO #7057, Norfolk, VA 23509.

MODERNIZE YOUR TRANSCEIVER — With Protronics RIT kit, for only \$15.90 postpaid. Kit comes complete with custom potentiometer and simple step by step instructions. Add \$2.50 for XIT. Visa/Master Charge. Protronics, 20 Monte Vista, Buckley, WA 98321. 1-206-829-0056.

MAKE HAM RADIO FUN! Supplement your learning programs with a motivational hypnosis cassette. Tape #3, Learning the Code; Tape #4, Breaking the Speed Barrier; Tape #7, Electronic Theory. Free catalog. For tapes, \$10.95 each to Gem Publishing, 3306 North 6th St., Coeur d'Alene, ID 83814.

CORDLESS TELEPHONES — Low prices, all major brands. Inquiries or Visa/MasterCard orders call (206) 743-3977 or Write Trinetics, Box 6005, Lynnwood, WA 98036.

VERY in-ter-est-ing! Next 5 issues \$2. Ham Trader "Yellow Sheets", POB356, Wheaton, IL 60187.

MICROWAVE CONVERTERS, decoders. Catalog 20c. G.W. Electronics, P.O. Box 688, Greenwood, Indiana 46142.

CB TO 10 METER PROFESSIONALS: Your rig or buy ours — AM/SSB/CW. Certified Communications, 4138 So. Ferris, Fremont, Michigan 49412; (616) 924-4561.

AFC SEMI-KITS! Stop VFO drift. See June 1979 HR. \$55.00 plus \$3.00 UPS. Mical Devices, P.O. Box 343, Vista, CA 92083.

HAMS FOR CHRIST — Reach other Hams with a Gospel Tract sure to please. Clyde Stanfield, WA6HEG, 1570 N. Albright, Upland, CA 91786.

SATELLITE TELEVISION...HOWARD/COLEMAN boards to build your own receiver. For more information write: Robert Coleman, Rt. 3, Box 58-AHR, Travelers Rest, SC 29690.

WANTED: Early Hallicrafter "Skyriders" and "Super Skyriders" with silver panels, also "Skyrider Commercial", early transmitters such as HT-1, HT-3, HT-19, and other Hallicrafter gear, parts, accessories, manuals. Chuck Dachis, WD5EOG, The Hallicrafter Collector, 4500 Russell Drive, Austin, Texas 78745.

WANTED: Surplus 1-3 KW HF transmitter type FRT-15, Collins TDH or equivalent. P.J. Plishner, 2 Lake Ave. Ext., Danbury, CT 06810. WA1LDU.

YAESU OWNERS: Join your International Fox-Tango Club, now in its eleventh year. Calendar year dues still only \$8 US, \$9 Canada, \$12 airmail elsewhere. Don't miss out, get 1982 top-rated FT Newsletters packed with modifications monthly, catalog of past modifications, free advertisements, technical consultation, FT net (Saturdays, 1700Z, 14.325 MHz), more. Go Fox-Tango! To join, send dues to FT Club, Box 15944, W. Palm Beach, FL 33406.

GET OFF YOUR EARPHONES and start laughing. "Slices of Ham" is a light-hearted look at Amateur Radio. N1ADX has collected more than a dozen short stories to brighten your shack. For witty, technical humor send \$5 (mailed anywhere). Add \$1 for airmail overseas. Massachusetts residents add sales tax. Parsley Press (H), Box 94 Turnpike Station, Shrewsbury, MA 01545 USA.

Coming Events ACTIVITIES "Places to go..."

CALIFORNIA: The Southern California DX Club's 1982 International DX Convention, Saturday, April 17 and Sunday, April 18, Holiday Inn, Visalia. Pre-registration \$35.50 and for first 500 may include a surprise gift. Pre-registrations received by April 9 are eligible for pre-registration prize. Door registration \$37.00. Registration includes admittance to all events, Saturday banquet, Sunday champagne brunch and a chance for many prizes. Extra chances may be purchased. Make all checks payable to: Southern California DX Club. For information: Don Bostrom, N6IC, 4447 Atoll Avenue, Sherman Oaks, CA 91423.

CONNECTICUT: The fifth annual P.V.R.A. Flea Market, Sunday, May 2, George Penny High School, East Hartford, exit 91 off I-86. Tables \$8.50; admission donation \$1.00. 10 AM to 4 PM. For information or advance tables: Arnie, K1NFE, PO Drawer M, Plainville, CT 06062.

ILLINOIS: The Centralia Wireless Association's annual Hamfest, Kaskaskia College Gym, 3 miles N.W. of Centralia, Sunday, May 2. Talk in on 147.27/87 and 146.52. Doors open 7 AM. No charge for flea market/exhibit space. Free admission; free parking. Refreshments available. Prizes throughout the day. Prize tickets \$1.00 each; 6/\$5.00. SASE for ticket orders to Centralia Wireless Association, Hamfest Tickets, PO Box 1166, Centralia, IL 62801. For information: Bud King, WB9QEG, (618) 532-6806. Lou Hodges, W9JL (618) 533-4724 or write CWA, Inc. at above address.

ILLINOIS: The Lake County Radio Control Club's Radio Control Expo V; static model airplane contest, Saturday, May 1 and Sunday, May 2, Lakehurst Shopping Center, Rt 120 and 41, Waukegan. Saturday 10 AM to 5:30 PM; Sunday 12 noon to 5:00 PM. Over 100 model airplanes competing for ribbons and trophies. All contestants eligible for door prizes. RC car and tank demonstrations. The Palos Air Show Team will give a 1-1/2 hour outside show. For entry information call John Russell (312) 249-3060 or Ed Fuerst (312) 336-7505.

ILLINOIS: The Moultrie Amateur Radio Klub's 21st annual Hamfest, April 18, Moultrie County 4-H Center Fairgrounds, 5 miles east of Sullivan on Cadwell Rd. Indoor and covered outdoor flea market, no charge to vendors. Talk in on 146.94 and 146.655/055. For information: Ralph Zancha, N9CDK, PO Box 55, Lovington, IL 61937. (217) 873-5287.

ILLINOIS: The Rock River Amateur Radio Club's 16th annual Hamfest, Sunday, April 25, Lee County 4-H Club Center, one mile east of junction of Rts 52 and 30, South of Dixon. Advance tickets: \$2.00 donation; \$2.50 gate. Grand prize \$500 cash; second prize \$200 cash (need not be present to win). Hourly door prizes (must be present to win). Talk in on 146.52 simplex. For advance tickets: Ed Webb, WD9CJB, 618 Orchard, Dixon, IL 61021.

MASSACHUSETTS: Quannapowitt Radio Association (QRA) will hold an indoor/outdoor Hamfest, Saturday, May 1, 9 AM to 4 PM, South Hall Fire Station, corner of Salem and Summer Sts, Lynnfield. Admission: \$1.00 door. Tables \$7.00 door; advance \$5.00. Food available. Talk in on 146.19/79 or 52. For details: Dave Meldrum, KA1MI, 28 Cedar Ln., No. Andover, MA 01845.

Tell 'em you saw it in HAM RADIO!

Power Line Filters

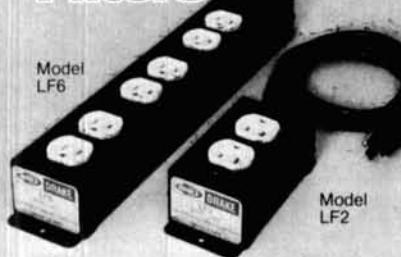

These filters protect any sensitive electronic equipment from power line transient damage and radio frequency interference. Both models offer common mode and differential mode surge suppression for power line "spikes". Rf interference is suppressed using both inductive and capacitive components. Ideal for computers, test equipment or TV.

- LF2 a duplex outlet, 120V, 8 amps max ... **\$39.95**
 - LF6 three separately filtered duplex outlets, 120 V, total fused capacity 15 amps, power switch and indicator lamp ... **\$59.95**
- Add \$2.50 shipping and handling per order.

Send check with order and provide street address for UPS shipment. Ohio residents add Sales Tax. Charge card buyers may call toll free:

1-800-543-5612



In Ohio, or for information call:
1-513-866-2421

R. L. DRAKE COMPANY

540 Richard Street, Miamisburg, Ohio 45342

INSTITUTIONAL AND DEALER INQUIRIES INVITED.

RED HOT SPECIALS

- AZDEN PCS 3000 2m Xcvr..... 283.00
- SAANTEC 144 µp 2m Handheld 297.00
- KDK 2025A MkII w/TT Mike 269.00
- JANEL QSA5 2m Preamp 36.50
- BEARCAT 20-20 Scanner 269.00
- KANTRONICS FDII Code Reader 360.00
- All MFJ Items 12% off list
- TEN-TEC Argosy Xcvr 469.00
- TEN-TEC Delta Xcvr 738.00
- JEN-TEC Omni D Xcvr 1040.00
- TEN-TEC Hercules Amp 1297.00
- AZDEN PCS 300 2m Handheld 288.00
- KANTRONICS Interface 165.00

Prices subject to change without notice.
SASE for our Large Specials and Used Equipment Lists

BEN FRANKLIN ELECTRONICS

115½ N. Main Hillsboro, KS 67063
316-947-2269

OUR COMPANY is looking to purchase or cooperate with an existing manufacturer of Amateur Radio components or accessories. We have a well established marketing organization that is looking for additional products to sell. Hook up with us and you'll be satisfied with the results. If interested, please send product information and details to:

P.O. Box 0

HAM RADIO MAGAZINE
Greenville, NH 03048

MASSACHUSETTS: A general Amateur Radio outdoor Flea Market, May 2, sponsored by the New England Amateur TV Group, Freeport Hall, Dorchester, just off S.E. expressway. Rain or shine. Admission: \$1.00. Sellers \$4 pre-registration by April 25 to NEAT, PO Box 406, Boston, MA 02102. \$7 at gate. Talk in on 145.29 Repeater or 52 direct.

MASSACHUSETTS: The Wellesley Amateur Radio Society's annual auction, Saturday, April 17, Wellesley High School Cafeteria, Rice Street, Wellesley. Talk in on 63-03, 04-64 and 52. Doors open 10 AM. Contact: Kevin P. Kelly, WA1YHV, 7 Lawnwood Place, Charlestown, MA 02129.

MASSACHUSETTS: The Fall River Amateur Radio Club's Flea Market, Sunday, May 23, American Legion Hall, Freetown, 10 AM to 4 PM. Flea market spaces \$7.00 advance, \$9.00 door (price includes 2 admissions). Free coffee. Talk in on 147.63/03 and .52 direct. Check or money order to Fall River Amateur Radio Club c/o Ann M. Carro KA1DNB, 652 Old Colony Terrace, Tiverton, RI 02878.

MINNESOTA: The Arrowhead Radio Amateur Club's annual swapfest, Saturday, May 8, First United Methodist Church, 230 East Skyline Parkway, Duluth. Admission: \$2.00 advance; \$2.50 door. Door prizes include an Icom 2AT. Raffle prizes include a Regency D100 programmable scanner and portable B/W TV. Raffle ticket donation \$1.00; 6/\$5.00. Reserved 4-foot tables \$3.00 advance, \$3.50 door. Doors open 10 AM to 3 PM. Food, free parking, hourly prize drawings. Talk in on 34/94. For information, advance reservations, raffle tickets: SASE to Jerry Frederick, NØBNG, 1127 — 104th Avenue West, Duluth, MN 55808.

MISSISSIPPI: The Jackson Amateur Radio Club will host the ARRL State Convention, Saturday, April 17, noon to 5 PM and Sunday, April 18, 8 AM to 2 PM, Raymond Road National Guard Armory, Jackson. Forums, net and special activity group meetings, exhibits, prizes and flea market. Food available. Free admission. Swap tables \$5.00 each day. Talk in on 146.16/76, 146.52 and 3987.5. For information/table reservations: Don Elder, KC5VD, 2806 N. Mill St., Jackson, MS 39216. (601) 362-0336.

NEW HAMPSHIRE: The Great Bay Radio Association's 2nd annual Hamfest-Flea Market, Saturday, April 17, Somersworth Armory, Somersworth, 9 AM to 3 PM. Antique radios and computers displayed. Hourly door prizes. Grand raffle for Radio Shack color computer and other prizes. Refreshments available. Free parking. Entrance fee \$1.00 per person (ticket counts for door prizes). For information/registration: Dick Sedgewick, N1EX, (603) 742-3703 or write Great Bay Radio Association, Rt. 16, Dover, NH 03820.

NEW JERSEY: The Tri-County Radio Association's annual Indoor Hamfest/Flea Market, May 2, 9 AM to 4 PM, Pas-saic Township Youth Center, Valley Road, Stirling. Donation \$2.50. Tables \$6.00. Hot food and refreshments available. An ICOM IC-2AT will be one of many door prizes. Talk in on 247.855/255 and 146.52. For information/table reservations: Jack Sammarco, 2062 Emerson Ave., Union, NJ 07083 or call Herb Klawunn, W2CHA (201) 647-3461.

NEW JERSEY: The 7th Trenton Computer Festival, Saturday and Sunday, April 17/18, 10 AM to 5 PM, Trenton State College, Trenton. Exhibits, flea market, technical sessions, free short courses on Sunday. Admission: \$5.00 (\$3.00 students). For information: TCF-82 Trenton State College, Hillwood Lakes CN550, Trenton, NJ 08625. (609) 771-2487.

NEW YORK: The Southern Tier Amateur Radio Club's 23rd annual Hamfest, Saturday, May 1, Owego Treadway, Owego, 9 AM to 5 PM. Outside flea market, dealer displays, door prizes and refreshments. Talk in on 146.22/82 and 146.16/76. For information: Craig England, KF2X, RD #1, Box 144, Vestal, NY 13850.

OHIO: The 13th annual B*A*S*H will be held on the Friday night of the Dayton Hamvention, April 23, at the Convention Center, Main and Fifth Streets. Parking in adjacent City Garage. Admission is free to all. Sandwiches, snacks and C.O.D. bar available. Live entertainment provided for a super social evening. Don't miss it... Awards include a new synthesized HT and a synthesized pocket scanner. For further information contact the Miami Valley FM Assn., PO Box 263, Dayton, OH 45401.

SOUTH CAROLINA: The Greenville Hamfest sponsored by the Blue Ridge Amateur Radio Society will be held at the American Legion Fairgrounds, White Horse Road, 1/2 mile north of I-85 in Greenville, May 1 and 2. Admission \$3.00 at the gate, no advance sales. Talk-in on 146.01/61 and 223.46/224.06. For further information write Hamfest Chairman, Gary D. Whidy, Rt. 6, Box 268, Travelers Rest, South Carolina 29690.

TENNESSEE: The Memphis Mini-Fest, Saturday only, April 3, 8 AM to 5 PM, Pipkin Bldg, Mid South Fairgrounds. Admission \$1.00. Flea Market space \$5.00 or 2 spaces \$8.00. Bring own tables/chairs. Hospitality party

REPEATER TAIL CHOPPER

SQUELCH TAIL ELIMINATOR

Better than 6db Sinad Sens.
Wide temperature range.
Tone enable-disable.

TC-2000 Regency U10R	\$69.95
TC-2100 Universal	\$79.95
TC-2200 PC Mt.	\$54.95

Easy installation for most repeaters

---TAIL CHOPPER---

CIRCUIT ELECTRONICS, INC.
 332 N. 9th St., Salina, KS 67401
 Call 913-827-4521

FCC STUDY GUIDE — RADIO TELEPHONE OPERATOR LICENSE

IT'S AMAZING HOW EASY FCC EXAMS REALLY ARE!

TESTS-ANSWERS FOR FCC GENERAL RADIO TELEPHONE OPERATOR LICENSE

The Original Tests-Answers Exam manual prepares you at home for FCC Radio telephone licenses. You get the complete set of multiple-choice examinations—covering all areas tested on the actual FCC exam. Also included—helpful study tips, short cuts, and "Self-Study Ability Test." These updated FCC Tests-Answers take the mystery out of preparing for current FCC exams. Practical proven Material. \$12.95 postpaid.

SEND TO:
HAM RADIO'S BOOKSTORE
 Greenville, NH 03048
 Please rush me Tests-Answers for FCC License. My \$12.95 is enclosed.

Name _____
 Address _____
 City _____ State _____ Zip _____

Call 603-878-1441

CERTIFIED INTERNATIONAL

YOU WILL BE GLAD YOU CHECKED WITH US FOR
 CUSHCRAFT AND HUSTLER (full line at 25% off), LARSEN, UNADILLA, BELDEN, COPPERWELD, SIGNALCRAFTER, PALOMAR, NYE-VIKING, TRIONYX, TRAC, JANEL, BENCHER, VIBROPLEX, AMPHENOL, GOULD, WELLER, EVEREADY AND OTHERS

WE STOCK EVERY KIND OF WIRE THE AMATEUR NEEDS.
 BY BELDEN, others
 CRYSTALS FRESH CUT TO YOUR ORDER FROM \$4.00

QSL'S CUSTOM MADE FOR YOU!

CB TO 10 METER CONVERSIONS FROM THE STANDARD SETTER
CERTIFIED COMMUNICATIONS
 WE CONVERT OVER 150 MODELS \$45 AND UP,
 AND SELL NEW 10 METER RIGS WITH DOUBLE
 WARRANTY FROM \$179.00

ASK FOR QUOTE, CATALOG, CONVERSION BOOKLET,
 QSL SAMPLES (INCLUDE 50 cents), OR INFORMATION

WE BRING OUR STORE TO YOU AT OVER 70 HAMFESTS PER YEAR.
 SEE US IN OAK RIDGE, MUSKOGON, DAYTON, ROCHESTER, MN AND MADISON, WI.

IT'S WORTH YOUR WHILE TO CALL OR WRITE

CERTIFIED INTERNATIONAL
 4138 South 4th Ave. (616) 924-4561 (Evening: 91-4941)

Alaska Microwave Labs

4335 EAST FIFTH STREET ANCHORAGE
ALASKA 99504 (907) 338-0340 DEPT HR

<p>TRANSISTORS</p> <p>MPF 901 P-45 GAZ \$3.00 MPF 911 P-50 GAZ \$4.00 EPR 90 P-50 GAZ \$3.00 EPR 91 P-50 GAZ \$3.50 NEC 02757 P-45 GAZ \$3.25 NEC 02795 P-45 GAZ \$5.00 NEC 04575 P-50 GAZ \$4.00</p>	<p>GAAS PETS</p> <p>MGF 1400 \$19.00 MGF 1412 \$61.00 MGF 1720 \$14.00</p>
<p>IC'S</p> <p>MWA-110 \$8.25 MWA-120 \$8.70 MWA-130 \$9.20 MWA-520 \$10.00 NEC MC 5471 \$13.30 NEC 5471 PILL \$7.45 NEC 5472 USR 1.75 MC 1358 (CA 3045) 2.50</p>	<p>CAPACITORS</p> <p>5000 P 500V 10% \$50 1000 P 500V 10% \$50 470 P 500V 10% \$50 100 P 500V 10% \$50</p>
<p>COAX CONNECTORS</p> <p>50 OHM SMA PLUG \$1.95 50 OHM SMA PLUG \$1.95 50 OHM SMA PLUG \$1.95 50 OHM SMA PLUG \$1.95 50 OHM SMA PLUG \$1.95 50 OHM SMA PLUG \$1.95 50 OHM SMA PLUG \$1.95 50 OHM SMA PLUG \$1.95</p>	<p>MIXERS</p> <p>3.7-4.2 GAZ \$50.00 3.7-4.2 GAZ \$50.00 3.7-4.2 GAZ \$50.00 3.7-4.2 GAZ \$50.00 3.7-4.2 GAZ \$50.00 3.7-4.2 GAZ \$50.00 3.7-4.2 GAZ \$50.00 3.7-4.2 GAZ \$50.00</p>
<p>RF CABLE</p> <p>1/4" Semi-Rigid \$4.00 1/4" Semi-Rigid \$4.00 1/4" Semi-Rigid \$4.00 1/4" Semi-Rigid \$4.00 1/4" Semi-Rigid \$4.00 1/4" Semi-Rigid \$4.00 1/4" Semi-Rigid \$4.00 1/4" Semi-Rigid \$4.00</p>	<p>DUAL GATE MOSFET</p> <p>9CA 40675 \$45.00</p>
<p>HOT CARRIER DEDES</p> <p>MFD 101 \$2.00 MFD 4131 \$2.00 MFD 1 \$2.00</p>	<p>SILVER PLATING</p> <p>1000 P 500V 10% \$50 1000 P 500V 10% \$50 1000 P 500V 10% \$50 1000 P 500V 10% \$50 1000 P 500V 10% \$50 1000 P 500V 10% \$50 1000 P 500V 10% \$50 1000 P 500V 10% \$50</p>
<p>PICOP TRIMMERS</p> <p>TRUNO (ZC1-01M) \$2.50 1-18K 1/2W 1/4" \$2.50 1-18K 1/2W 1/4" \$2.50</p>	<p>VTO'S</p> <p>VZ-71 \$98.00 VZ-72 \$98.00 VZ-73 \$98.00 VZ-74 \$98.00 VZ-75 \$98.00 VZ-76 \$98.00 VZ-77 \$98.00 VZ-78 \$98.00</p>

OPEN AT 8PM EST CLOSED 8PM PST
ORDERS ARE POSTAGE PAID
GOD-NIB-A-MASTER CHARGE
IF YOU DO NOT SEE
WHAT YOU WANT ASK

Saturday night. For further details: Mid South Amateur Radio Assn. President Clayton Elam, K4FZJ, 28 N. Cooper St., Memphis, TN. 274-4418 (days) and 743-6714 (nights).

TENNESSEE/VIRGINIA: The Bristol, Johnson City and Kingsport Amateur Radio Clubs' 2nd Tri-Cities Hamfest, May 1 and 2, Appalachian Fairgrounds, Gray, Forums, dealers, flea market. Only two hours away from the 1982 World's Fair that starts May 1. For further information: Tri-Cities Hamfest, PO Box 3682 CRS, Johnson City, TN 37601.

VIRGINIA: The Lynchburg Amateur Radio Club's annual Swapfest, May 2, Brookville High School, route 460 west of Lynchburg. Large covered tailgating area and plenty of food. Talk in on 146.01/146.61. Details via: PO Box 4242, Lynchburg, VA 24501.

WASHINGTON: The Yakima Amateur Radio Club's annual Hamfest, May 1 and 2, Ahtanum Youth Activities Park, Yakima. Doors open 9 AM Saturday. Dealers, a super prizes raffle, free swap and shop. Lunch available both days. Breakfast 6 AM Sunday. For information: David Pankey, N7BRB, 512 So. 7th Street, Yakima, WA 98901.

WISCONSIN: The Ozaukee Radio Club's 4th annual Swapfest, Saturday, May 8, Circle B Recreation Center, Highway 60, Cedarburg (20 miles north of Milwaukee), 8 AM to 1 PM. Admission \$2.00 advance; \$3.00 door. 8 foot tables \$3.00. Door prizes, food, refreshments. For information or tickets: SASE to Ozaukee Radio Club, PO Box 13, Port Washington, WI 53074.

WISCONSIN: The 3F Amateur Radio Club's Swapfest, Saturday, May 8, 8 AM to 3 PM, Neenah Labor Temple. Admission \$1.50 advance, \$2.00 door. Tables \$1.50 advance, \$2.00 door. Prizes, food, beverages. Auction at end of day. Talk in on 146.16/146.76 and 146.52. A semi-formal banquet available Saturday evening, \$8.00 per person to advance ticket holders only. For information or tickets: Mark Michel, W9OP, 339 Naymut Street, Menasha, WI 54952. (414) 722-4034 (after 0000Z).

KNOXVILLE TENNESSEE: See World's Fair while attending 1982 Knoxville Hamfest and ARRL Delta Division Convention, Memorial Day Weekend (May 22-23). DX, computer, and technical forums; air-conditioned exhibit area; and large indoor/outdoor flea market make this Tennessee's largest Hamfest. More information? (dealers, tickets, reservations) N4BAQ, 5833 Clinton Hwy., Suite 203, Knoxville, Tenn. 37912.

MAY 8: The Greater Fairfield Amateur Radio Association's special Dogwood Festival QSO Party. Members of the club (WB1COO) will be on six Amateur bands to explain significance of the festival. 1300-2200 UTC or 9 AM to 6 PM EDT. SSB frequencies: 3.975, 7.235, 14.330, 21.420 and 28.710 MHz. FM: 146.55 simplex. For a special, commemorative QSL card send SASE or IRCs to QSL manager, Grace von Stein, KA1JT, 248 Euclid Avenue, Fairfield, CT 06432.

MAY 15: In observance of Armed Forces Day, an Amateur Radio station will be operating from the United States Air Force Museum at Wright-Patterson Air Force Base near Dayton, Ohio using the call sign, K8DMZ, from 1400Z to 2200Z on Saturday. Operators will work primarily in the General Class phone segments of 75, 40, 15 and 10 meters with periodic CW excursions to the Novice subbands. FM and SSB operation on 2 meters is planned. This will be the first time an Amateur Radio station has operated from the Museum in conjunction with a special event and to commemorate this, the Museum will issue a special certificate for each two-way contact.

MAY THROUGH OCTOBER: The 1982 World's Fair in Knoxville will feature a special events Amateur Radio station sponsored by The Tennessee Wireless Association. The station will operate all bands 160-2m, all modes and will be on display to the public. Guest operators are welcome subject to rules laid down by the chief operator. For details: Jerry Goodchild, K4DZR, 3701 Warner Dr., Apt. 213, Knoxville, TN 37912.

PLAYBOY RESORT at Great Gorge, McAfee, NJ — the place to relax and enjoy — see all the manufacturers' and dealers' exhibits — attend the vital and informative forums — renew old acquaintances and make new ones — all at the ARRL Hudson Division Convention, October 30-31. Send SASE now for complete details to HARC, Box 528, Englewood, NJ 07631.

SCHOLARSHIPS: The Foundation for Amateur Radio, Inc., a non-profit organization with headquarters in Washington, DC plans to award nine scholarships for the academic year 1982-1983. The Foundation, composed of fifty local-area Amateur Radio clubs, fully funds two of these scholarships from the proceeds of the Gaithersburg (MD) Hamfest and administers, without cost to donors, two scholarships for the Quarter Century Wireless Association and one each for the Richard G. Chester Memorial, The Radio Club of America, the Young Ladies' Radio League, the Edmund B. Redington Memorial and the Amateur Radio News Service. Radio Amateurs holding at least an FCC General Class license or equivalent may compete for one or more of these awards if they plan to pursue a full-time course of studies beyond high school and are enrolled or have been accepted by an accredited university, college or technical school. Awards range from \$300 to \$900. For additional information and application form, send letter or QSL postcard prior to May 31, 1982 to: Hugh A. Turnbull, W3ABC, 6903 Rhode Island Avenue, College Park, MD 20740.

OPERATING EVENTS

"Things to do..."

APRIL 10: The Missouri Valley Amateur Radio Club's third annual Pony Express Day, from 1000 CST to 1900 CST commemorating the original running of the Pony Express from St. Joseph, Missouri to Sacramento, California. In addition, the Club is also offering a "wanted" poster of outlaw Jesse James as this will be the 100th anniversary of his death. Anyone contacting club station W0NH is eligible to receive both certificates. Phone frequencies: 10 Kc's from bottom of general phone bands on 15, 20, 40 and 75 meters. 10 meters - 28.575. CW: 28.150 on 10, 21.150 on 15 and 7.125 on 40. To receive certificates send two first-class stamps and a QSL card to Missouri Valley Amateur Radio Club, W0NH, 401 N. 12th Street, St. Joseph, Missouri 64501.

APRIL 17 & 18: A Novice Mini-Expedition. The North Texas High Frequency Association will be operating the Novice bands from Novice, Texas, from 1800Z Saturday to 1800Z Sunday. Call sign KC5YN will operate near center of the Novice bands at your calling speed. For a commemorative QSL send legal-sized SASE to North Texas High Frequency Association, Denton, Texas 76201.

APRIL 17 & 18: W9YCR, The Quad Cities Amateur Radio Club, Rock Island, Illinois, will operate a special events station commemorating the first bridge across the Mississippi River. W9YCR will be on the air from 1800 UCT Saturday through 1800 UCT Sunday. 80 - 10 meters. Frequencies: middle of CW portion of each Novice class band, as low as possible in the General CW portion of each band and 30 kHz up from lower edge of the General SSB portion of each band. For a commemorative certificate send QSL and business SASE to: Denny Spurgeon, N9BKY, 413 - 23rd Avenue, Moline, IL 61265.

MAY 7 & 8: The Indian River Amateur Radio Club in conjunction with the Florida Solar Energy Center at Cape Canaveral will participate in a "Sun-Day" exercise using club call, W4NLX/4 and, at that time, will be operating completely on solar power. 1300-1400 GMT, 40 meters, 7,250 to 7,275 kHz, SSB. 1400-2000 GMT, 15 meters, 21,350 to 21,375 kHz, SSB. For a certificate confirming contact or reception (free to each station or short wave listener sending a QSL) SASE (Foreign 1 IRC) to: Florida Solar Energy Center, "Sun-Day", 300 State Route 401, Cape Canaveral, FL 32920.



July 31 thru August 13, 1982

Our 23rd year

Have trouble finding time to study for Upgrading? Do it on your vacation at the
OAK HILL ACADEMY RADIO SESSION
in the
Blue Ridge Mountains of Virginia

Two weeks of intensive Code and Theory Study starting at your level.

- Novice to General
- General or Technician to Advanced
- Advanced to Amateur Extra

Expert Instructors — Friendly Surroundings — Excellent Accommodations.
Ham Lab set up for all to use.

"A Vacation with a Purpose"

C. L. PETERS, K4DNJ, Director
Oak Hill Academy Amateur Radio Session
P. O. Box 1461, N. Myrtle Beach, SC 29582
(803) 272-6428

Name _____ Call _____

Address _____

City/State/Zip _____

ATTENTION DEALERS!
Interested in making a PROFIT?

Sell our magazine in your store with 100% Return Privileges
Rose will tell you how —
CALL 1-603-878-1441

The Ham Radio Publishing Group
Greenville, NH 03048



Transi-Trap lightning protection

The conventional air-gap lightning protector design affords virtually no protection to solid-state components, since its breakdown voltage and response time are unpredictable because of the arc-forming characteristics of the molecules of air between electrodes in an air-gap protector.

By comparison, the Alpha Delta Transi-Trap gas tube protector design encloses the gap in a hermetically sealed ceramic tube filled with an isotope of known breakdown characteristics and response time. As a result, the variable and unpredictable nature of the ionized particles is minimized. This yields a protector design with a known response time of 100 nanoseconds and a predictable breakdown voltage with a tolerance of ± 15 percent, compared with the approximate breakdown tolerance of 100 percent for the air-gap. Also, breakdown voltage and response time are not affected by humidity, temperature, altitude, and pressure changes; they are with the air-gap.

The Transi-Trap protector design allows devices to be set to fire at the lowest possible lightning pulse level for maximum protection of solid-state receivers and transceivers (Model R-T protector), or at a higher voltage level for protection of amplifiers, both tube-type and solid-state (Model HV protector). By using special constant-impedance brass tubing design for the in-line circuitry, excellent performance through 500 MHz is realized (typically 0.1 dB loss at 500 MHz).

For more information, contact Alpha Delta Communications, 116A North Main Street, Centerville, Ohio 45459.

Big Ben mike stand

Mobile radio operators who use their equipment in the base station will find their job made easier by the new Big Ben Mike Stand by Valor Enterprises, Inc. The new mike stand allows the operator to convert his mobile microphone to a base station microphone.

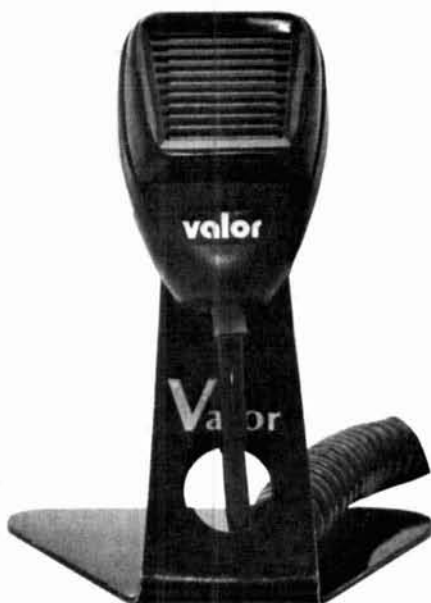

Valor manufactures Big Ben microphone stands in both black (Model 221) or polished chrome (Model 221C). The stand is part of a complete line of personal and Amateur communications products and accessories offered by Valor Enterprises, Inc., West Milton, Ohio 45383. A complete catalog is available by calling 513-698-4195.

Commsoft Codem

The Commsoft Codem, a universal CW interface for personal computers, is now available for Radio Amateurs. The Codem provides an easy way to get your Morse code software on the air. Converting received CW audio to RS232 or TTL signal levels and RS232 or TTL signal levels to transmitter keying, the Codem doubles as a code practice oscillator and CW regenerator.

HATRY'S

APRIL

Line-up

TEMPO HANDHELDS

VHF S-1, S-5, and S-2
UHF S-4
144, 220 and 440 MHz
Full line of accessories
and amplifiers

DAIWA METERS, SWITCHES and more CROSS NEEDLE SWR / POWER METERS

CN 520 69.95
CN 540 79.95
CN 550 89.95

TUNERS 3.5 to 30 MHz

CNW 418 199.95
CNW 518 330.00

AUTOMATIC TUNERS 3.5-30 MHz

CNA 1001 369.00
CNA 2002 499.95

MFJ Everything from KEYBOARDS to OSCILLATORS

MIRAGE VHF & UHF Amps

Call today for full line
of new & used equipment.

HATRY ELECTRONICS

500 LEDYARD STREET
HARTFORD, CT 06114

(203) 527-1881

SHIPPING F.O.B. HARTFORD, CT

ORR BOOKS

BEAM ANTENNA HANDBOOK

by Bill Orr, W6SAI

Recommended reading. Commonly asked questions like: What is the best element spacing? Can different yagi antennas be stacked without losing performance? Do monoband beams outperform tribanders? Lots of construction projects, diagrams, and photos. 198 pages. ©1977. 1st edition.

RP-BA Softbound \$5.95

SIMPLE LOW-COST WIRE ANTENNAS

by Bill Orr, W6SAI

Learn how to build simple, economical wire antennas. Apartment dwellers take note! Fool your landlord and your neighbors with some of the "invisible" antennas found here. Well diagramed. 192 pages. ©1972.

RP-WA Softbound \$6.95

THE RADIO AMATEUR ANTENNA HANDBOOK

by William I. Orr, W6SAI and Stuart Cowan, W2LX

Contains lots of well illustrated construction projects for vertical, long wire, and HF/VHF beam antennas. There is an honest judgment of antenna gain figures, information on the best and worst antenna locations and heights, a long look at the quad vs. the yagi antenna, information on baluns and how to use them, and new information on the popular Sloper and Delta Loop antennas. The text is based on proven data plus practical, on-the-air experience. **The Radio Amateur Antenna Handbook** will make a valuable and often consulted reference. 190 pages. ©1978.

RP-AH Softbound \$6.95

ALL ABOUT CUBICAL QUAD ANTENNAS

by Bill Orr, W6SAI

The cubical quad antenna is considered by many to be the best DX antenna because of its simple, lightweight design and high performance. You'll find quad designs for everything from the single element to the multi-element monster quad, plus a new, higher gain expanded quad (X-Q) design. There's a wealth of supplementary data on construction, feeding, tuning, and mounting quad antennas. 112 pages. ©1977.

RP-CQ Softbound \$4.75

Please add \$1.00 to cover shipping and handling.

HAM RADIO'S BOOKSTORE

GREENVILLE, NH 03048

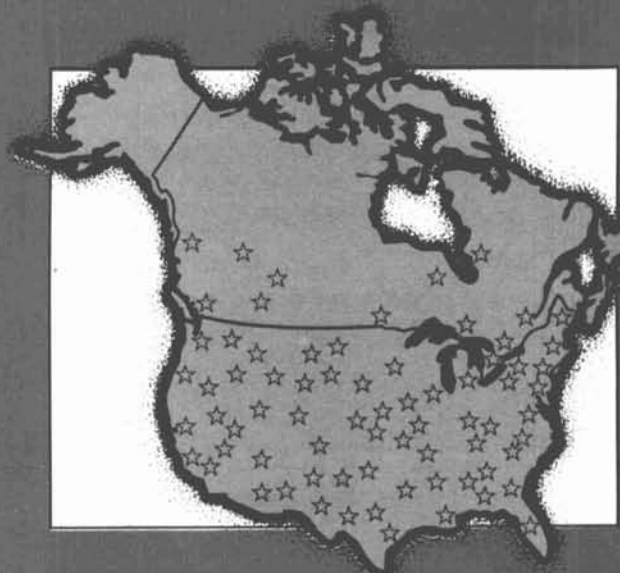

The places to buy ARCO Solar™ Power Systems are popping up everywhere.

For some very sound reasons. Not all solar electric systems are created equal. ARCO Solar products offer all the features that add up to superior performance and increased value. Features like design, construction, warranty, accessories and service. Those who know what dependable, stand-alone power can do for their communications equipment, know how important these features are.

And now, there are 2,500 dealers across the United States and Canada offering ARCO Solar power systems. For the name of the dealer nearest you, contact one of our regional distributors:

DENVER, CO
C.W. Electronic Sales
(303) 832-1111

LOS ANGELES, CA
Henry Radio
(213) 820-1234

DALLAS, TX
Hutton Companies
Dallas (214) 484-0580
Texas (800) 442-3811
Outside (800) 527-0827

NORTH HOLLYWOOD, CA
Wm. Lamb Company
(213) 980-8248

LENEXA, KS
North Supply Company
(913) 888-9800

SCOTTSDALE, AZ
Photocomm
(602) 948-8003

©ARCO Solar, Inc RH-4-82

HONOLULU, HI
Servco Pacific Inc.
(808) 841-3644

WILLITS, CA
Solar Electric Specialties
(707) 459-9498

SANTA BARBARA, CA
Solar West Electric
(805) 963-9667

**CALGARY
ALBERTA CANADA**
Westronics Engineering
(403) 253-5585

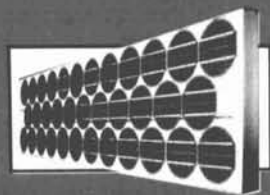

ARCO Solar, Inc. 
Subsidiary of AtlanticRichfield Company

STUDY TAPES

CODE PRACTICE TAPES FROM
HRPG — Practice copying Morse
Code anytime, anywhere. Whether
you're upgrading your present license or
just trying to up your code speed, a large
assortment allows you to choose exactly the
kind of practice you need.

each tape \$4.95 2/\$8.95 3/\$12.95

QSO SERIES

Here's the way to go for those planning to upgrade their present license to General or Extra Class. Both QSO tapes are reproductions of actual on-the-air CW contacts, similar in content to the FCC code exams. Both tapes are recorded at speeds faster than those encountered in the exams. Get the best practice for that all-important code test by mastering these tapes.

A 90 minute tape of 25 QSOs sent at 15 wpm.

HR-QSO-1 \$4.95

A 90 minute tape of 30 QSOs sent at 22.5 wpm

HR-QSO-2 \$4.95

PLAIN LANGUAGE TEXT SERIES

Now, there's an opportunity to practice copying code in plain language text, any time of the day. The PLT series is excellent for those who are learning code by the word method. These tapes can also be used to improve sending speed and accuracy by using the provided text and a code practice oscillator to send in time with the tape.

HR-PLT1 — \$4.95 HR-PLT2 — \$4.95

15 wpm code for 20 minutes

18 wpm code for 20 minutes

22 wpm code for 20 minutes

25 wpm code for 20 minutes

30 wpm code for 20 minutes

35 wpm code for 15 minutes

40 wpm code for 15 minutes

45 wpm code for 15 minutes

50 wpm code for 15 minutes

Please add \$1 for shipping.

Ham Radio's Bookstore
Greenville, NH 03048



A sharp 800-Hz bandpass filter, a-m detector and low pass filter are designed into the Codem to provide outstanding noise and QRM rejection. CW can be monitored using an internal 2-inch speaker or with an external high impedance earphone. Front panel sensitivity, tone and volume controls are provided. The Codem comes with a comprehensive manual that includes operating details and connection instructions. The Codem requires an external 9-Vdc power supply.

The price of the Codem is \$124.95. The 9-Vdc supply is \$9.95. Add \$5.00 for shipping and handling. California residents add applicable sales tax. VISA and MasterCard orders accepted.

For more information, contact Commsoft, 665 Maybell Avenue, Palo Alto, California 94306; telephone 415-493-2184.

Hy-Gain tribander

Hy-Gain introduces the TH7DX, a broadband tribander based on the excellent front-to-back characteristics of the older TH6DXX plus the superior VSWR characteristics of a dual-

driven element system. The combination produces an amazingly efficient broadband tribander without compromises.

During the development of the TH7DX, the company's engineering tests and research indicated that a higher average front-to-back ratio could be maintained on each band by employing a combination of trapped and monoband reflectors and directors rather than fully trapped parasitics. Also, the gain bandwidth was broader and average half-power beam width was smaller. Research also showed that other tribanders sacrificed gain and high front-to-back ratio to maintain a low VSWR across each band. And finally, none of the tested antennas covered all of the 10-meter band; most stopped at 29.2 or 29.4 MHz.

The new TH7DX features a dual driven element system that maintains a VSWR of less than 2:1 on all bands, including the entire 10-meter band. Both elements use Hy-Gain's efficient Hy-Q traps capable of handling power levels well in excess of the legal limits with a 2:1 safety margin. These traps permit element lengths of 0.225 wavelength on 10 meters, 0.203 wavelength on 15 meters, and 0.185 wavelength on 20 meters. The dual driven elements are fed directly with Hy-Gain's 50-ohm BN-86 balun. Hy-Gain's Beta Match provides a dc ground and matches each band to a



ISOTRON ANTENNAS

THE BEST THINGS
come in little packages...

FOR 80-40-20 METERS



NEEDS NO RADIALS OR
MATCHING DEVICES

ISOTRON 80 54 IN.HIGH	ISOTRON 40 31 IN. HIGH	ISOTRON 20 17 IN. HIGH
--------------------------	---------------------------	---------------------------

BIG ON PERFORMANCE

SMALL ON SPACE

BILAL COMPANY

(303) 687-3219

STAR ROUTE

FLORISSANT CO 80816

RADIO WAREHOUSE



OMNIC
\$1045⁰⁰



IC-730
\$699⁰⁰

R-1000.....	\$385.00
FRG-7700	\$465.00
TR-2500.....	\$295.00
FT-208R.....	\$319.00
TS-530S.....	\$595.00

Get
THEIR
lowest price
THEN CALL US!

P.O. BOX 2728
DALLAS, TX 75221
Telephone: (817) 496-9000

pro-am™

Mounts and Antennas

Commercial users and amateurs who demand the very best will find professional quality and performance with Valor's Pro-Am Communications products. As original equipment or replacements, Pro-Am antennas and mounting systems are compatible with the Motorola type TAD and TAE components. Stainless steel whips, heavy-duty, chrome-plated brass parts; weather-sealed, 200-watt low loss coils ensure long-lasting performance. Available from 27 MHz thru 866 MHz.

See us in Booth 459, 1982 Land Mobile Expo, Denver CO, March 22-25.

Write or call today for complete details.

valor Enterprises, Inc.

185 W. Hamilton St., West Milton, OH 45383
 PH: (513) 698-4194, Outside Ohio: 1-800-543-2197
 Telex: 724-389 ATT: Valor



IF WE WERE YOU



MODEL 6154 TERMALINE®

I'D BUY FROM US

YOUR INQUIRY OR ORDER WILL GET OUR PROMPT ATTENTION

AUTHORIZED **BIRD** DISTRIBUTOR

Webster
 associates

115 BELLARMINE
 ROCHESTER, MI 48063

CALL TOLL FREE
800-521-2333
 IN MICHIGAN 313 - 375-0420

AFFORDABLE CW KEYBOARD FROM \$69.95



Transmits perfect Morse Code * Built-in 16 character buffer * Internal speaker and sidetone * Reed relay output eliminates keying problems * All solid state circuits and sockets for reliability * Speed range 5-45 WPM * Perfect companion to our MORSE-A-WORD CW code reader.

- MORSE-A-KEYER KIT, model MAK-K, Complete kit of parts & manual \$159.95
- MORSE-A-KEYER, model MAK-F, Factory wired & tested \$199.95
- MORSE-A-KEYER ESSENTIAL PARTS KIT, model EPK-K. \$ 69.95
 (Essential parts kit for home-brewers consists of pc board, board parts and manual. You supply ASCII keyboard, cabinet, power supply & miscellaneous parts.)

Send check or money order. Use your VISA or MasterCard. Add \$5.00 shipping and handling for Continental U.S. Wisconsin residents add 4% Wisconsin State Sales Tax.

Microcraft

Corporation Telephone: (414) 241-8144
 Post Office Box 513HR, Thiensville, Wisconsin 53092

SMITHE

ALUMINUM
 6061-T6 TUBING VIA UPS!
 6' lengths

Diameter	.035 wall	.058 wall
1/4"	\$2.65	\$2.75
3/8	2.75	3.45
1/2	3.30	4.50
5/8	4.15	5.30
3/4	4.25	5.80
7/8	4.80	6.50
1	5.10	7.40
1 1/8"		8.25
1 1/4		9.10
1 3/8		10.40
1 1/2		11.55
1 5/8		12.50
1 3/4		13.25
1 7/8		13.75
2		14.95

Shipping: \$3.50 per order in U.S.
 COMPLETE CATALOG - 50 CENTS

SMITHE ALUMINUM P.O. BOX 273
 BONIFAY FL 32425 PHONE (904) 547-4411

OVER 70 BRANDS IN STOCK

LAND-MOBILE RADIO

Full Service Shop • Spectrum Analysis • Antennas
 New and Used Equipment • CW-SSB-FM, Etc. • Towers
 FCC Study Guides • Code Tapes • Books • Accessories

SPECTRONICS

Specialists in Amateur Radio,
 Short-Wave Listening
 And Contemporary
 Electronic Gear.

HOURS
 MON, TUES, WED.: 9:30-6:00 PM
 THURS, FRI.: 9:30-8:00 PM
 SAT.: 9:30-3:00 PM

BEARCAT • MORGAIN • MANY MORE

SPECTRONICS, INC.
 1009 GARFIELD ST. OAK PARK, IL. 60304 (312) 848-6777

DRAKE ICOM TEN-TEC BIRD B&W/CDE

SHORTWAVE SCANNERS

CLOSED SUNDAYS, HOLIDAYS

VISA

FACSIMILE

COPY SATELLITE PHOTOS,
 WEATHER MAPS, PRESS!
 The Faxes Are Clear — on our full size (18-1/2" wide) recorders. Free Fax Guide

TELETYPE

RTTY MACHINES, PARTS, SUPPLIES

ATLANTIC SURPLUS SALES (212) 372-0349
 3730 NAUTILUS AVE BROOKLYN, N.Y. 11224



THE GREAT ELECTRONIC THINGS & IDEAS BOOK!

HUNDREDS OF UNUSUAL PARTS, GADGETS & IDEA ITEMS. UNAVAILABLE IN STORES OR CATALOGS ANYWHERE! Bargain prices on everything! New items in every issue! Rush postcard for your copy!

ETCO ELECTRONICS
 Dept. 444
 Plattsburgh, N.Y. 12901



VSWR of less than 1.5:1 at resonance. Rugged phasing lines and preformed feed straps facilitate easy assembly and consistent results.

The TH7DX, complete with stainless steel hardware, BN-86 balun and heavy duty boom-to-mast clamp, is priced at \$499.95. For more information, contact Telex Hy-Gain, 9600 Aldrich Ave., So. Minneapolis, Minnesota 55420; telephone 612-884-4051.

Drake ESR24

The ESR24 earth station receiver has been introduced by the R.L. Drake Company, Miamisburg, Ohio. This 3.7-4.2 GHz receiver is designed for satellite television reception and features digital channel display, pre-set and variable audio subcarrier selector, AFC for stability, and full metering. For installation versatility, the down converter module (supplied) may be mounted internally or at the antenna. Accessories for the ESR24 include a remote control, a remote



tuning meter, and splash-proof housing. Attractive styling makes the ESR24 suitable for commercial or private installations. Price is under \$1,000.

R.L. Drake is recognized for high technology Amateur Radio, commercial, and maritime communications equipment. For more information, contact R.L. Drake Company, 540 Richard Street, Miamisburg, Ohio 45342; telephone 513-866-2421.

SURGE SHUNT



protects solid state communications equipment from damage caused by high-voltage transients entering the antenna system

These transients usually are caused by atmospheric static discharges or nearby lightning strikes.

The new Model 1549 Surge Shunt can be used with both receivers and transceivers having up to 200 watts output. Convenient UHF type coaxial connections are supplied. Price is \$24.95

The arrester "pill" element has a long life, but can be easily and economically replaced if necessary.

Credit-Card buyers may call toll free
1-800-543-5612



In Ohio, or for information call:
1-513-866-2421

R. L. DRAKE COMPANY
540 Richard Street, Miamisburg, Ohio 45342

INSTITUTIONAL AND DEALER INQUIRIES INVITED

APPLIED INVENTION

THE SOURCE FOR SOLID STATE / STATE-OF-THE-ART

GaAs FETS by MITSUBISHI

VHF through 18 GHz

MGF-1200 - \$13.00 (0.25dB NF at 144 MHz!)

MGF-1400 (2SK273) - \$19.25 MGF-1402 (2SK274) - \$34.00

1412 (2SK275) TESTED and GUARANTEED NF at 4 GHz
0.8dB - \$85.50 0.9dB - \$58.75 1.0dB - \$45.50

1403 (2SK276) (fmax=90GHz - Super Low Noise amp.)
\$97.00 - \$161.75 NF sorted - call for data

1801 (2SK279) (150mW linear PO at 10GHz) - \$54.25

Microwave Modules

MITSUBISHI X BAND Hybrid Integrated Circuits with Dielectric Resonator (0.12MHz/°C) GaAs FET Oscillators

FO-1010X - 10.4 GHz, 15mw out, UER100 Flange \$37.75

FO-1210Y - 11.5 or 12.0 GHz, UER120 Flange \$37.75

FO-UP11KF Heterodyne receiver, 10.488 GHz LO. \$34.25

Shottky mixer, high or low injection

All modules tuneable ±150 MHz; oscillators can be optically FM'd with IR (suggest LD271 below)

X-Band Horn antenna (15dB UER100/WR190 Flange) \$16.00

Components

NEW! RETICON R5620 digitally programmed Universal Active Filter.
Switched capacitor type, NO external components, 16pin DIP, \$12.00

VITRAMON 7800 Microwave Rated caps for bypass/coupling
7802P7G02 0.7-1.4GHz 7800P7G04 1.3-2.6GHz
7800P7G01 2.6-4.2GHz 5 for \$5.00

VOLTRONICS ultra-miniature shuttle caps and HI Q piston caps
Shuttle: CP2 0.1-2.5pf CP10 0.5-9.0pf \$3.19
Piston: ET9Q 0.6-9pf, Q = 5000 @ 100 MHz \$3.41

SOLDER-IN DISK CAPACITORS for VHF-UHF bypassing
RMC JF series 100, 220, 470, 680pf 10 for \$2.50

OPTOELECTRONICS from MITSUBISHI and SIEMENS
MITSUBISHI ML3001 LASER DIODES 3mW at 830 nm CW
30mA threshold, built in monitor. \$200 ea.

SIEMENS: LD271 high efficiency IR LED, 15 mW \$0.75
BPW-34 fast, large area PIN detector \$3.00

THERMOELECTRIC HEAT PUMPS for temperature control
MELCOR FRIGICHIPS \$21 - \$38. Call for data.

MINIMUM ORDER: \$5.00. ADD POSTAGE & HANDLING
\$3.50 on Modules (UPS) \$2.50 on other items
N.Y. STATE RESIDENTS ADD 6% SALES TAX
SEND S.A.S.E. FOR CATALOG

R.D.2 ROUTE 21 HILLSDALE, NY 12529
518-325-3911

STILL MORE USABLE ANTENNA FOR YOUR MONEY . . . PLUS 30 Meters!



Butternut's new HF6V automatic bandswitching vertical lets you use the entire 26-foot radiator on 80/75, 40, 30, 20 and 10 meters (full quarter-wave unloaded performance on 15 meters). No lossy traps. Butternut's exclusive Differential Reactance Tuning™ circuitry uses rugged ceramic capacitors and large-diameter self-supporting inductors for radiation efficiency and DX performance unmatched by conventional multiband designs of comparable height.

For complete information concerning the HF6V & other Butternut products see your dealer or write for our free catalog.



**BUTTERNUT
ELECTRONICS
CO.**

GARY AIRPORT
BOX 356E Rte. 2
SAN MARCOS, TX 78666



BUGGED BY MORSE CODE?

TURN THE MORSE CODE HASSLE INTO THE FUN IT SHOULD BE WITH THE NEW KEYER-TRAINER MODEL KT-2 BY AEA.

NEW ... \$89.95

Does not include DC-2 External Battery Pack

The new model KT-2 KEYER-TRAINER uses an AEA microcomputer with copywritten software, featuring exclusive automatic speed increase that literally pulls you through psychological speed barriers. Users of the model KT-1 predecessor report Morse code success never before achieved by all other methods tried. The exclusive AEA training method is increasing one's Morse speed copying ability in the shortest time, for all who want to learn.

In addition to the powerful trainer features, the KT-2 is also a full feature keyer which will interface with all the popular iambic or single lever paddles on the market. Best of all, the new KT-1 price represents a **30 percent reduction** from the KT-1 predecessor.

ACCESSORIES:

Model AC-2 350 Ma 12 VDC Wall Adaptor \$9.95
Model DC-2 8 Hour Rechargeable Battery Pack and Charger Unit \$39.95

PRICES AND SPECIFICATIONS SUBJECT TO CHANGE WITHOUT NOTICE

call or visit:

AEA
Brings you the
Breakthrough!

Advanced Electronic Applications, Inc.

P.O. Box 2160
Lynnwood, Washington 98036 USA
(206) 775-7373

QUALITY VHF/UHF KITS AT AFFORDABLE PRICES

Call or Write for **FREE CATALOG**
(Send \$1.00 or 3 IRC's for overseas mailing)
See our full page ad in 73 Magazine



FM TRANSCEIVERS
FM & AM RECEIVERS
FM EXCITERS & XMTRS
FM & SSB POWER AMPS
RECEIVING & TRANSMITTING
CONVERTERS FOR FM & SSB
LOW-NOISE PREAMPS
CWID's, COR's, RF TIGHT CASES

For Repeaters, Links, OSCAR, ATV, Mobile, Base, Scientific

hamtronics, inc.

65-R MOUL RD. • HILTON NY 14468
Phone 716-392-9430

Hamtronics is a registered trademark

HAMVENTION
'82
DAYTON

- ★ Technical Forums
- ★ ARRL and FCC Forums
- ★ GIANT 3-Day Flea Market
- ★ New Products and Exhibits
- ★ Grand Banquet
- ★ Women's Activities
- ★ New! Home-Brew Equipment Forum
- ★ Special Group Meetings
- ★ YL Forum

- ★ New! Personal Computers Forum
- ★ Amateur of Year Award
- ★ Special Achievement Awards

April 23, 24, 25, 1982

Hara Arena and Exhibition Center — Dayton, Ohio

Meet your amateur radio friends from all over the world at the internationally famous Dayton HAMVENTION. Seating will be limited for Grand Banquet and Entertainment on Saturday evening so please make reservations early. Banquet speaker is Roy Neal, K6DUE, NBC News.

If you have registered within the last 3 years you will receive a brochure in late February. If not write Box 44, Dayton, OH 45401.

Nominations are requested for Radio Amateur of the Year and Special Achievement Awards. Nomination forms are available from Awards Chairman, Box 44, Dayton, OH 45401.

For special motel rates and reservations write to Hamvention Housing, 1406 Third National Bldg., Dayton, OH 45402. **NO RESERVATIONS WILL BE ACCEPTED BY TELEPHONE.**

All other inquiries write Box 44, Dayton, OH 45401 or phone (513) 849-1720.

Rates for ALL 3 Days: Admission: \$7 in advance, \$8 at door.
Banquet: \$14 in advance, \$16 at door.
Flea Market Space: \$15 in advance.

Make checks payable to Dayton HAMVENTION, Box 333, Dayton, OH 45405.

Bring your family and enjoy a great weekend in Dayton.

Sponsored by the Dayton Amateur Radio Association, Inc.

STUDY TAPES

CODE PRACTICE TAPES FROM
HRPG — Practice copying Morse
Code anytime, anywhere. Whether
you're upgrading your present license or
just trying to up your code speed, a large
assortment allows you to choose exactly the
kind of practice you need.

each tape \$4.95 2/\$8.95 3/\$12.95

CODE PRACTICE TAPES

Here are three different straight code tapes consisting of randomly generated six character groups sent at different speeds. These tapes are excellent for building both the speed and copying accuracy needed for contesting, DXing and traffic handling.

- HR-STC1 — \$4.95 HR-STC3 — \$4.95
7.5 wpm code for 25 minutes 25 wpm code for 20 minutes
10 wpm code for 25 minutes 30 wpm code for 20 minutes
15 wpm code for 25 minutes 35 wpm code for 20 minutes
 HR-STC2 — \$4.95 40 wpm code for 20 minutes
15 wpm code for 50 minutes
22.5 wpm code for 35 minutes

HI/LO SERIES — Code Study Tapes

In this unique series, characters are sent at high speeds with long pauses between each character. For example, HLC4 (15/2.5 wpm) consists of characters sent at a 15 wpm rate, but with 2.5 wpm spacing between each character. These tapes are excellent for the beginner who wants to practice copying higher speed code without the frustration of constantly getting behind.

- HR-HLC1 — \$4.95 HR-HLC3 — \$4.95
22.5/2.5 wpm code for 80 minutes 15/5 wpm code for 28 minutes
 HR-HLC2 — \$4.95 15/7.5 wpm code for 28 minutes
22.5/5 wpm code for 20 minutes 15/10 wpm code for 28 minutes
22.5/7.5 wpm code for 20 minutes HR-HLC4 — \$4.95
22.5/10 wpm code for 20 minutes 15/2.5 wpm code for 80 minutes
22.5/13 wpm code for 20 minutes

Please add \$1 for shipping.

Ham Radio's Bookstore
Greenville, NH 03048



SATELLITE TELEVISION SYSTEMS

WE WILL NOT BE UNDERSOLD!!

**Complete Systems, Antennas,
Receivers, LNA's & Accessories**

CALL US TODAY!

812-238-1456

**hoosier
electronics**

"Nation's Largest Total Communications Distributor"
P.O. BOX 3300 • TERRE HAUTE, INDIANA 47803

TIDBITS

2ND OP

by Jim Rafferty, N6RJ

Completely revised and updated with all of the latest information, the latest 2nd Op is an indispensable operating aid for all Radio Amateurs. The 2nd Op gives you at the twist of a dial: prefixes in use, continent, zone, country, beam heading, time differential, postal rates, QSO and QSL record and the official ITU prefix list. Every ham needs a 2nd Op. Order yours today. ©1981, N6RJ's 1st Edition.

HR-OP \$6.95

Please add \$1.00 for shipping and handling.

HAM RADIO'S BOOKSTORE
GREENVILLE, NH 03048

**MIRAGE
MIRAGE
MIRAGE**
COMMUNICATIONS EQUIPMENT, INC.

**5 YEAR
WARRANTY**

Parts and Labor
1 yr. on RF Power Transistors

Peak Reading
Watt/SWR Meters

MPI — HF
1.8 to 30 mhz
25, 200, 2000
watts ± 5%
\$119.95
MP2 — VHF
50 to 200 mhz
50, 500, 1500
watts ± 5%
\$119.95

2 Meter
"All Mode"
Amplifiers
FM - SSB - CW

B108 10 W. in = 80 W. out	\$179.95
B1016 10 W. in = 160 W. out	279.95
B3016 30 W. in = 160 W. out	239.95
B 2 3 2 W. in = 30 W. out	89.95

These amplifiers, except B23, have built in RX preamps. The B108 and B1016 may be used with HTs or transceivers. They will key with 1 Watt input.

RC - I Remote Control \$24.95

SEE YOUR NEAREST DEALER FOR INFORMATION

MIRAGE COMM. EQUIP., INC. • P.O. BOX 1393 • GILROY, CA 95020 • (408) 847-1857

New!!

**D1010 430-450
Amplifier**

"ALL MODE" FM-SSB-CW-ATV

10 W. in = 100+ W. out	\$319.95
2 W. in = 25+ W. out	

Advertisers check-off

... for literature, in a hurry — we'll rush your name to the companies whose names you "check-off"

Place your check mark in the space between name and number. Ex: Ham Radio 234

AEA ___ 677	Jameco ___ 333
Alaska Microwave ___ 826	K & S ___ 903
All Elec. ___ 926	Kenwood * ___
Alpha Delta ___ 949	KLM ___ 073
Aluma ___ 589	LaRue Elec. ___ 961
ARRL ___ 780	MFJ ___ 082
Applied Inv. ___ 862	Madison ___ 431
Arco Solar ___ 965	Microcraft ___ 774
Atlantic Surplus *	Microwave Filter ___ 637
Barker & Williamson ___ 015	Mirage ___ 760
Barry *	N.P.S. ___ 866
Bauman ___ 017	Nemal ___ 968
Bencher ___ 629	Oak Hill Academy A. R. S. * ___
Ben Franklin ___ 864	P.B. Radio ___ 921
Bilal ___ 817	P.C. ___ 766
Butternut *	Palomar Eng. * ___
Certified Int. ___ 976	Panasonic ___ 683
Circuit Elec. ___ 863	Penn Wireless * ___
Commsoft ___ 978	Phillips-Tech ___ 936
Comm. Concepts ___ 797	Callbook ___ 100
Comm. Spec. ___ 330	Radios Unlimited ___ 941
Dayton Hamvention *	Radio Warehouse * ___
Diversified Sales ___ 979	Radio World ___ 592
Drake *	Sherwood * ___
EEB ___ 288	Smithe ___ 930
ETO *	Spectronics * ___
ETCO ___ 856	Spectrum Int. ___ 108
G & K ___ 967	Ten-Tec * ___
GLB ___ 552	Texas Towers ___ 681
G.I.S.M.O. ___ 691	The Comm Center ___ 634
Hal Comm. ___ 057	Universal Comm. ___ 885
Hal-Tronix ___ 254	Universal Elec. ___ 653
H. R. B. ___ 150	UNR-Rohn ___ 410
Ham Shack ___ 879	Valor ___ 946
Hamtronics, N.Y. ___ 246	Vanguard Labs ___ 716
Hatry ___ 889	Varian ___ 043
Hoosier ___ 977	Webster Assoc. ___ 423
Hy-Gain/Telex ___ 693	Wheeler App. Res. Lab ___ 931
Icom *	Yaesu ___ 127
Int. Crystal ___ 066	

*Please contact this advertiser directly.
Limit 15 inquiries per request.

April, 1982

Please use before May 31, 1982

Tear off and mail to
HAM RADIO MAGAZINE — "check off"
Greenville, N. H. 03048-0498

NAME

CALL

STREET

CITY

STATE ZIP

look here

call toll free: nights
1-800-231-3057
7-10 PM CT, M.W.F.
days 1-713-658-0268

Hygain	TH7DX	349.00
ICOM	IC 3AT / IC 4AT	269.00 ea.
	IC 25A	309.00
	IC 730	699.00
	IC 2AT	239.00
	IC 22U	269.00
KLM	KT34XA	469.00
	KT34A	309.00
Santec	HT 1200	269.00
	ST 144UP	299.00
Telrex	10% Off List on Stock Items	
	HAM4	185.00
	HAMX	265.00
Drake	TR5	995.00
	R7 / DR7	1299.00
AEA	Morsematic	169.00
	CK1 Contest	115.00
	MBA-RO Reader	269.00
Order KWM380		3095.00
	& 2 Free Filters	
	High Serial Numbers, All Mods	
Amphenol Silverplate		
	PL259	1.00 ea
	Antique rare Tubes	Call
Timex	24 Hour Wallclock	24.95
Robot	800A	749.00
	400	675.00
Hal	CT2100	699.00
	KB2100	159.00
New CWR	685A Telereader	875.00
Cubic	103	1195.00
Bird	43 Slugs	Stock
Drake	Theta 7000	995.00
Belden	9405 Heavy Duty Rotor	
	Cable 2#16, 6#18	45¢ ft.
Belden	8214 RG-8 Foam	36¢ ft.
Belden	9258 RG8x Mini-Coax	19¢ ft.
Belden	8267RG 213	
	Non Contam Jacket	43¢ ft.
Alliance	HD73	109.95
10% Off Curtis, Sherwood, Palomar		
Call Quotes Kenwood TS830S, TS530S, TS130S, NEW DRAKE TR7A/R7A We Want Special Orders!		
Yaesu Specials	New FT1	2395.00
	FT 707	649.00
	FT101ZD / Mark 3	749.00
	FT208R or 708R	289.00
	Used Clean Corner	
Collins	75A4	350.00 ea
	KWM2 / PM2	700.00
	CX7A / B with Mods	1000.00
	TS820S / CW	600.00
	516F2	200.00

MASTERCARD VISA

All prices fob Houston except where indicated. Prices subject to change without notice, all items guaranteed. Some items subject prior sale. Texas residents add 6% tax. Please add sufficient postage, balance collect.

MADISON
Electronics Supply
1508 McKinney
Houston, Texas 77010

Advertisers index

AEA, Advanced Electronic Applications	90
Alaska Microwave Labs	84
All Electronics Corp.	72
Aluma Tower Company	69
American Radio Relay League	63
Applied Invention	89
Arco Solar, Inc.	86
Atlantic Surplus Sales	88
Barker & Williamson, Inc.	55
Barry Electronics	25
Bauman, R. H., Sales Company	67
Bencher, Inc.	64
Ben Franklin Electronics	83
Bilal Company	87
Butternut Electronics	89
Certified International	83
Circuit Electronics, Inc.	83
Communications Concepts	67
Communications Specialists	96
Dayton Hamvention	90
Diversified Sales	31
Drake, R.L., Co.	2, 52, 63, 83, 89
EEB	30
Ehrhorn Technological Operations	1
ETCO	88
G & K Amateur Supply	67
GLB Electronics	95
G.I.S.M.O.	47
Hal Communications Corp.	44, 45
Hal-Tronix	68
Ham Radio's Bookstore	47, 64, 68, 73, 83, 86, 91
The Ham Shack	81
Hamtronics, N.Y.	90
Hatry Electronics	85
Hoosier Electronics	91
Icom America, Inc.	Cover II
International Crystal	56
Jameco Electronics	65
K & S Enterprises	63
Trio-Kenwood Communications	48, 49
KLM Electronics, Inc.	80
LaRue Electronics	69
MFJ Enterprises	9
Madison Electronics Supply	6, 92
Microcraft Corporation	88
Microwave Filter, Inc.	55
Mirage Communications Equipment, Inc.	91
N.P.S., Inc.	69
Nemal Electronics	81, 95
Oak Hill Academy Amateur Radio Session	84
P.B. Radio	30
P.C. Electronics	73
Palomar Engineers	95
Panasonic	46
Penn Wireless Association	95
Phillips-Tech Electronics	64
Radio Amateur Callbook	82
Radios Unlimited	64
Radio Warehouse	87
Radio World	72
Sherwood Engineering	69
Smithe Aluminum	88
Spectronics	88
Spectrum International, Inc.	73
Ten-Tec	11
Texas Towers	63
The Comm Center	75
Universal Communications	37, 69
Universal Electronics, Inc.	69
UNR-Rohn	47, 72
Valor Enterprises, Inc.	88
Vanguard Labs	72
Varian, Eimac Division	Cover IV
Webster Associates	88
Wheeler Applied Research Lab	67
Yaesu Electronics Corp.	Cover III

Advertisers check-off

... for literature, in a hurry — we'll rush your name to the companies whose names you print below.

It's simple to do. Simply select the advertiser's number and name from the Advertisers' Checkoff list found on the same page as the Advertisers' Index. Just print the number and the company's name and drop in the mail.

NUMBER	NAME OF COMPANY	NUMBER	NAME OF COMPANY
_____	_____	_____	_____
_____	_____	_____	_____
_____	_____	_____	_____
_____	_____	_____	_____
_____	_____	_____	_____
_____	_____	_____	_____
_____	_____	_____	_____

Please month _____ Mar. _____ April _____ May _____ **Limit 14 inquiries please.**

NAME _____ CALL _____

ADDRESS _____

CITY _____ STATE _____ ZIP _____



AFFIX POSTAGE
OR
POST OFFICE
WILL NOT
DELIVER

ham
radio
magazine

READER SERVICE CENTER
P.O. BOX 358
ARLINGTON, MA 02174

ATTN: Reader Service Dept.



DXPEDITION AT SEA!!!

PENN WIRELESS ASSOCIATION, INC.

presents

A HAM DXPEDITION AT SEA

aboard the

Royal Caribbean Lines M/S SUN VIKING
October 31st — November 10th, 1982

YOUR DXPEDITION INCLUDES:

- Free round trip air fare from most major gateway cities in the U.S.
- Free round trip transfers from Miami Airport to the M/S SUN VIKING
- 10 day cruise on the M/S SUN VIKING with five ports of call: St. Thomas, Antigua, Barbados, Martinique and St. Croix.
- Three Ham Seminars at sea featuring Bill Orr W6SAI as discussion leader.
- Operational Ham Shack for participants.
- All Port Taxes

Prices start at just \$1,585.00 per person

For more information:

PENN WIRELESS ASSOCIATION, INC.

c/o Plaza II Travel

1158 Oxford Valley Rd.

Levittown, PA 19057

Or call Bill (W2ALG) at: (215) 943-0190

2 Meter Quad

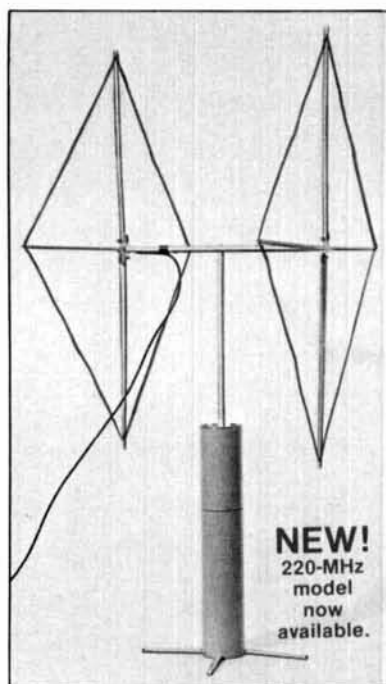

- Portable. Collapsible.
- Folds into its own base for portability.
- For backpackers, apartment dwellers — an antenna that stores compactly when not in use.

New portable quad extends the range of low power two meter transceivers by providing the gain and front-to-back discrimination of a two element quad. Gives the gain of a linear amplifier but does not require additional battery power. Users report full quieting on repeaters that are marginal with 5/8 wave whips.

The entire beam slips into an 18" carrying case to go in your suitcase. For use, it unfolds to form a two element full size quad complete with stabilized mounting stand. Patented design lets you set it up or take it down in minutes. See the cover article QST September 1980 for full details.

Order direct or from your favorite dealer. Model A-502 portable 2-meter quad or Model A-505 portable 220-MHz quad \$87.50. Add \$3 shipping/handling. California residents add sales tax.



Palomar Engineers

1924-F W. Mission Rd., Escondido, CA 92025
 Phone: (714) 747-3343



Super
 Specials
 *

NEMAL ELECTRONICS COAXIAL CABLE SALE

POLYETHYLENE DIELECTRIC

RG213 noncontaminating 95% shield mil spec	36"/ft
RG214/U double silver shield 50 ohm	\$1 35/ft
RG62U 93 ohms	10"/ft
RG11U 96% shield 75 ohm mil spec	25"/ft
*RG-8/U 96% shield Mil Spec (\$23.95/100) or 31"/ft	
RG6A/U double shield 75 ohm	25"/ft
RG-55B/U double shield (RG-58 size) 50 ohm	50"/ft
RG58U mil spec 95% shield	11"/ft

LOW LOSS FOAM DIELECTRIC

*RG-8X (Mini 8) 95% shield (\$14.95/100) or 17"/ft	
RG8U 80% shield	18"/ft
RG-8/U 97% shield 11 gauge	30"/ft
RG58U 80% shield	07"/ft
RG58U 95% shield	10"/ft
RG59/U 100% foil shield TV type	07"/ft
Rotor cable 2-18 ga 6-22 ga	19"/ft

CONNECTORS MADE IN USA

PL-259 push on adapter shell	10/\$3.89
PL-259 & SO-239	10/\$5.89
Double Male Connector	\$1.79
PL-258 Double Female Connector	98¢
1 ft patch cord w/RCA type plugs each end	3/\$1.00
Reducer UG-175 or 176	10/\$1.99
UG-255 (PL-259 to BNC)	\$3.50
Elbow (M359) Silver Plated	\$1.79
F59A (TV type)	10/\$1.99
UG 21 D/U Type N Male for RG8, Amphenol	\$3.00
UG-88C/U BNC Male for RG-58, Amphenol	\$1.25
Double Female N Chassis Mt. UG-30	\$4.75
3/16 inch Mike Plug for Collins etc.	\$1.25

Call or write for Free Catalog

shipping

Cable — \$3.00 1st 100 ft., \$2.00 each add'l 100 ft.

Connectors — add 10%, \$1.50 minimum.

COD add \$1.50. Florida Residents add 4%.

NEMAL ELECTRONICS

5685 SW 80th St., Dept. H, Miami, FL 33143

Telephone: (305) 661-5534

GLB

HIGH PERFORMANCE PRESELECTORS

MODEL P50 to P500



- 50 - 500 MHz
- Ultimate rejection over 80 dB
- Five large helical resonators
- Low noise
- High overload resistance
- Typical rejection figures:
 ± 600 kHz at 144 MHz: -30 dB
 ± 1.6 MHz at 220 MHz: -40 dB
 ± 5 MHz at 450 MHz: -45 dB
- The solution to interference, intermod and desens problems on repeaters
- 12V DC operation
- Dimensions only 1.6 x 2.6 x 4.75 excluding connectors
- Custom tuned to your frequency
- Low cost — only \$69.95
- Allow \$2.00 for shipping and handling

We have a complete line of transmitter and receiver strips and synthesizers for Amateur and commercial use. Write or call for our free catalog

We welcome MasterCard or VISA

GLB ELECTRONICS

1952 Clinton St., Buffalo, N. Y. 14206

1-(716) 824-7936, 9 to 4



Food for thought.

Our new Universal Tone Encoder lends its versatility to all tastes. The menu includes all CTCSS, as well as Burst Tones, Touch Tones, and Test Tones. No counter or test equipment required to set frequency—just dial it in. While traveling, use it on your Amateur transceiver to access tone operated systems, or in your service van to check out your customers' repeaters; also, as a piece of test equipment to modulate your Service Monitor or signal generator. It can even operate off an internal nine volt battery, and is available for one day delivery, backed by our one year warranty.

- All tones in Group A and Group B are included.
- Output level flat to within 1.5db over entire range selected.
- Separate level adjust pots and output connections for each tone Group.
- Immune to RF
- Powered by 6-30vdc, unregulated at 8 ma.
- Low impedance, low distortion, adjustable sinewave output, 5v peak-to-peak
- Instant start-up.
- Off position for no tone output.
- Reverse polarity protection built-in.

Group A

67.0 XZ	91.5 ZZ	118.8 2B	156.7 5A
71.9 XA	94.8 ZA	123.0 3Z	162.2 5B
74.4 WA	97.4 ZB	127.3 3A	167.9 6Z
77.0 XB	100.0 1Z	131.8 3B	173.8 6A
79.7 SP	103.5 1A	136.5 4Z	179.9 6B
82.5 YZ	107.2 1B	141.3 4A	186.2 7Z
85.4 YA	110.9 2Z	146.2 4B	192.8 7A
88.5 YB	114.8 2A	151.4 5Z	203.5 M1

- Frequency accuracy, $\pm .1$ Hz maximum - 40°C to + 85°C
- Frequencies to 250 Hz available on special order
- Continuous tone

Group B

TEST-TONES:	TOUCH-TONES:	BURST TONES:			
600	697 1209	1600	1850	2150	2400
1000	770 1336	1650	1900	2200	2450
1500	852 1477	1700	1950	2250	2500
2175	941 1633	1750	2000	2300	2550
2805		1800	2100	2350	

- Frequency accuracy, ± 1 Hz maximum - 40°C to + 85°C
- Tone length approximately 300 ms. May be lengthened, shortened or eliminated by changing value of resistor

Model TE-64 \$79.95

COMMUNICATIONS SPECIALISTS

426 West Taft Avenue, Orange, California 92667
(800) 854-0547/ California: (714) 998-3021



FT-230R: QUITE A SIGHT! (AND EASY TO SEE, TOO!!)

Sporting an all-new Liquid Crystal Display, the FT-230R is Yaesu's high-performance answer to your call for a very affordable 2 meter mobile rig with an easy-to-read frequency display! The FT-230R combines microprocessor convenience, a sensitive receiver, a powerful yet clean transmitter strip, and the new dimension of LCD frequency readout. See your Authorized Yaesu Dealer today — and go home with your new FT-230R!



SALE SUBJECT
FCC CERTIFICATION

- LCD five-digit frequency readout with night light for high visibility day or night.
- Two VFOs for quick QSY across the band.
- Ten memory slots for storage and recall of favorite channels.
- Selectable synthesizer steps (5 kHz or 10 kHz) in dial or scanning mode.
- Priority channel for checking a favorite frequency for activity while monitoring another.
- Unique VFO/Memory Split mode for covering unusual repeater splits.
- Up/Down band scan plus memory scan for busy or clear channel. Scanning microphone included in purchase price.
- Full 25 watts of RF power output from extremely compact package.
- Built-in automatic or manual tone burst.
- Optional synthesized CTCSS Encode and Encode/Decode boards available.
- Lithium memory backup battery with estimated lifetime of five years.
- Optional YM-49 Speaker/Microphone and YM-50 DTMF Encoding Microphone provide maximum operating versatility.

And don't forget! Yaesu has a complete line of VHF and UHF handheld and battery portable transceivers using LCD display!!!

FT-208R
FM Handheld
2 Meters

FT-708R
FM Handheld
70 cm

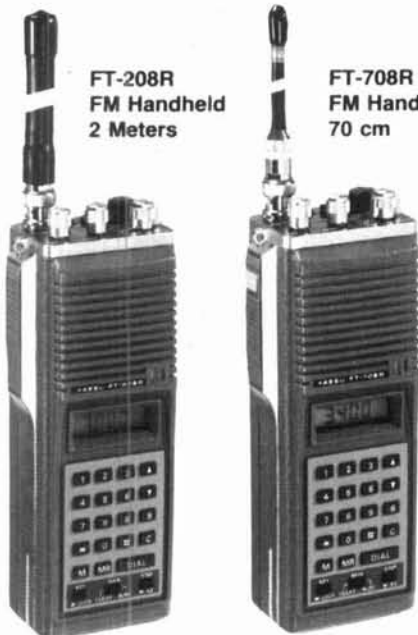

FT-290R - 2 Meters
SSB/CW/FM Portable
FT-690R - 6 Meters
USB/CW/AM/FM Portable



YAESU
The radio.



Price and Specifications Subject To
Change Without Notice or Obligation

482



EIMAC's 4CW300,000G Power Tetrode. A new generation of high-performance power tubes.

EIMAC's 4CW300,000G combines all the desired features transmitter designers look for: high peak plate current, low grid emission, low internal capacitances and low internal inductance. This is the first of a new generation of high performance power tubes for LF, HF, VHF and pulse service.

Laserfab pyrolytic graphite grids

The control grid and screen structures of the 4CW300,000G are precision-cut by a laser beam. Each element is monolithic and combines extremely low coefficient of expansion with low structural inductance. These features permit the 4CW300,000G to have a very high transconductance— 10^6 micromhos—and allow efficient, high-frequency operation.

Rugged mesh filament

The EIMAC mesh filament provides exceptionally high peak plate current and permits low plate voltage operation. This leads to power supply economy, making the 4CW300,000G the economic choice for 300 KW AM broadcast service or long-pulse switch service, each of which demands a reserve of peak emission.

Improved anode structure

EIMAC's multi-phase cooling technique provides high plate dissipation to extract heat evenly and quickly from the anode, contributing to long tube life and operating economy.

EIMAC expertise

EIMAC's expertise in electron ballistics pyrolytic grid production, thermodynamics and circuit techniques combine to bring tomorrow's tubes for to-

day's transmitter designs. More information is available from Varian EIMAC. Or the nearest Varian Electron Device Group sales office.

Electron Device Group
Varian EIMAC
Application Engineering
Department
301 Industrial Way
San Carlos, CA 94070
Telephone: 415-592-1221, ext. 218

Varian AG
Steinhauserstrasse
CH-6300 Zug, Switzerland
Telephone: (042) 23 25 75
Telex: 78 841

